

# **Antennas Made of Wires Volume 2**

***Simple & Effective***

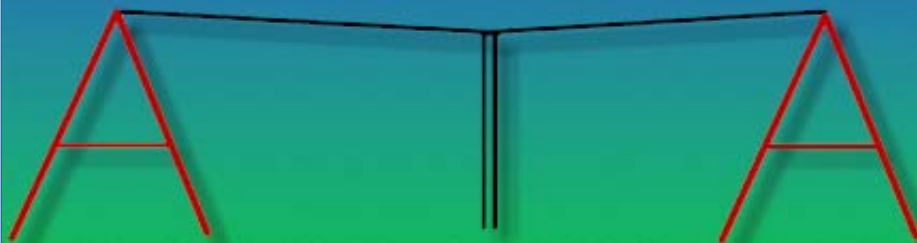

**A Collection from the Works  
of L.B. Cebik, W4RNL**

---

**Antennas  
Made of Wires  
Volume 2**

---

---

***Published by***  
***antenneX Online Magazine***

<http://www.antennex.com/>

POB 271229

Corpus Christi, Texas 78427-1229 USA

---

---

Copyright © 2010 by Publisher ***antenneX Online Magazine***. All rights reserved. No part of this book may be reproduced or transmitted in any form, by any means (electronic, photocopying, recording, or otherwise) without the prior written permission of the publisher.

ISBN: 1-877992-86-0

---

## About the Author

L. B. Cebik, W4RNL, passed away in April 2008. He had written extensively about antennas and antenna modeling (as well as other electronics subjects) in most of the U.S. ham journals, including QST, CQ, Communications Quarterly, QEX, Ham Radio, 73, QRP Quarterly, Radio-Electronics, and QRPP. Besides the continuing series of antenna modeling columns he does for *antenneX* (*continues through 2010*), he also wrote a column for 10-10 News (An-Ten-Ten-nas) and another for Low Down (Antennas from the Ground Up). A life member of ARRL, he served as both Technical and Educational Advisor. Several years ago, LB joined the position as Technical Editor for *antenneX*.



L. B. has published over two dozen books, with works on antennas for both the beginner and the advanced student. Among his books are a basic and intermediate tutorial in the use of NEC antenna modeling software and compilations of his many shorter pieces. Some 30 of these books have been published by *antenneX* and listed in the BookShelf at our website.

He was a ham since 1954 and also a life member of QCWA and of 10-10 International. He also maintained a web site ( <http://www.cebik.com> ) on which he has placed a large collection of entries from his notebooks and publications sponsored by *antenneX*. A PhD and a teacher for over 30 years, he retired as professor emeritus of philosophy at the University of Tennessee, Knoxville. *antenneX* is/was very fortunate, indeed, to have had LB as a member of its writing team and Tech Editor for some 12 years.

I for one, lament daily at the tragic loss of one of my closest friends.  
— *Jack L. Stone, Publisher*

## PREFACE

*“it’s not just wires anymore, it’s an antenna!”*

**W**hile numerous articles and books have described various wire antenna designs, but here is a series of new books from the works of antenna master, L.B. Cebik, W4RNL (SK). He is known the world over for his unique ideas about new ways to "bend wires" to get the most out of them. With LB's guidance, your success is practically guaranteed. It would be a rare occasion indeed that any design recommended by this author will not work as described. One can proceed with that confidence in mind.

This book is dedicated to the design, construction and use of antennas of various types of wire. The reader can save a lot of time and effort by reading these books. Then, experiment to your heart's content with an aim toward the goal of achieving the best signal for your unique environment.

With wire, antennas are very simple and easy to build at a very lowest of cost to achieve one's goal. This book will demonstrate a number of designs from conventional antenna wisdom. How satisfying is it to twist and bend wires together and make connections only to suddenly discover, ***it's not just wires anymore, it's an antenna!***

One book is not enough to describe all of the best-known and LB's unique designs, but we shall continue with this second Volume picking up where Volume 1 left off and progress toward the more complex designs. Volume 3 to follow.

Along with some recommended wires, a pair of gloves and simple hand tools, wonders will sprout from your efforts quickly. And, with wires, such designs can be made to fit within the closest of environments. Many tips are suggested about how to make cramped spaces an asset rather than a liability—and keep your neighbors friendly as well.

We know the reader, newbie or advanced, will enjoy this book by one of the masters and have fun in the process!

## Table of Contents

Chapter 27: About the Folded Dipole-----	7
Chapter 28: The Terminated Wide-Band Folded Dipole-----	39
Chapter 29: Wide-Band Multi-Wire Folded Dipoles-----	76
Chapter 30: More on Wide-Band Multi-Wire Folded Dipoles-----	105
Chapter 31: About the Folded Monopole-----	142
Chapter 32: Short Folded Monopoles - Some Basics-----	169
Chapter 33: Short Folded Monopoles – Extended Applications-----	212
Chapter 34: A Doublet as a Good Single Choice Antenna-----	256
Chapter 35: Inverted-Vee Doublet Patterns-----	274
Chapter 36: About the All-Band Doublet-----	285
Chapter 37: The Zig-Zag Dipole Doublet-----	316
Chapter 38: The Y-Doublet-----	331
Chapter 39: The Doublet - Trap or Not?-----	347
Chapter 40: Some Notes on Triangles of Doublets-----	353
Chapter 41: 40-Meter Vertical Arrays-----	384
Chapter 42: Wire Elements in Lower HF Arrays-----	428
Chapter 43: The Collinear-Broadside Endfire Array-----	454
Chapter 44: The Extended Lazy-H-----	474
Chapter 45: The Expanded Lazy-H-----	486
Chapter 46: Explaining the Modern Dipole Curtain Array-----	500
Chapter 47: The 2-Element Vertical Phased Array-----	530
Chapter 48: The Terminated Vee-Beam and Rhombic-----	557
Chapter 49: The Controlled Current Distribution (CCD) Antenna-----	569
Chapter 50: A Universal HF Back-Up Antenna-----	595
Other Publications-----	616

## Chapter 27: About the Folded Dipole

The folded dipole is a simple antenna to build. However, it has acquired something of a complex web of correct and incorrect information surrounding it. The points of this note is to sort out some of the information, with an emphasis upon what it is correct to say about the folded dipole.

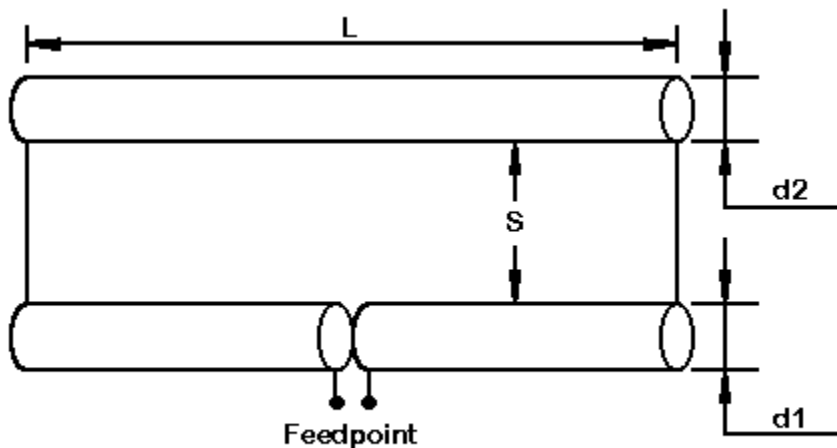

The Basic Elements of a Folded Dipole

Fig. 1

**Fig. 1** shows the essential elements of a folded dipole. It consists of two parallel wires having a constant spacing,  $S$ . Each wire has a certain diameter,  $d1$  and  $d2$ . The ends of the parallel wires are connected to form a continuous loop. The feedpoint is at the center of the wire having the diameter  $d1$ .

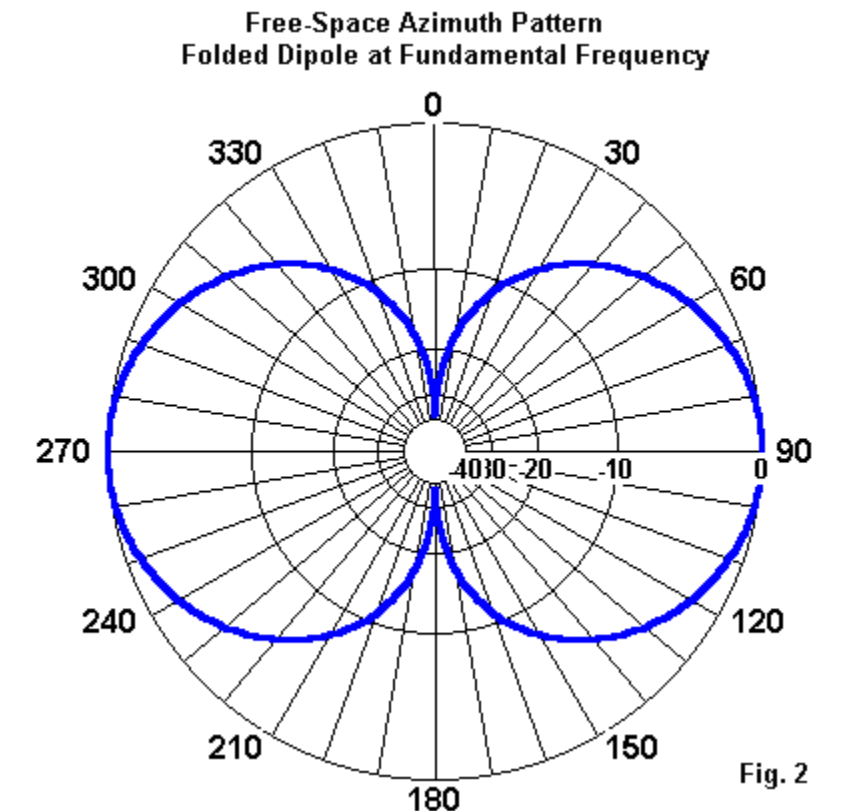

We can construct a folded from common materials ranging from house wire to parallel transmission line. With such materials, we can obtain the pattern shown as a free-space azimuth pattern in **Fig. 2**--the same pattern as a single-wire dipole. The folded dipole is a reliable antenna, meaning that we can get it to work without lots



of finicky adjustments. Something about the ease of building an antenna seems to go hand-in-hand with not getting a firm grasp on why it works.

In calling the antenna a folded dipole, we should note that the term "dipole" is important to our discussion. "Dipole" is a term that we use as shorthand for a longer characterization of a single wire antenna. The 1-wire antenna described is a  $1/2$  wavelength long, resonant, 2-pole antenna. The reference to length is obvious. Being resonant means that the feedpoint impedance will have negligible reactance and hence be purely or close to purely resistive. Having 2 poles means having two transitions from maximum to minimum current--in this case stating at the current maximum located at the center of the antenna.

Now all that we need to deal with is the folded aspect of the antenna. Folding refers not only to the visual appearance of the antenna, but as well to what folding does. Folding a single wire antenna (and thereby doubling the amount of wire needed) creates a combination of an antenna element and an impedance transformer. The same principle has been used with other antenna types. For example, the side-fed rectangle--a good vertically polarized performer for the lower HF bands--has a low feedpoint impedance. Doubling the loop with a crossover at the far end from the feedpoint raises the impedance of the antenna.

Using antenna transformer techniques to raise the impedance of an antenna does not reduce any losses inherent in the antenna operation. Loss resistances will also be transformed. These losses

are not significant with the standard horizontal folded dipole, but have been a major misunderstanding of its cousin, the folded monopole.

## The Folded Dipole as an Impedance Transformer

Our understanding of the folded dipole has been stunted in part by our use of only a special case within the range of possible transformations. By using the same diameter wire for both  $d_1$  and  $d_2$ , we always end up with a 4:1 impedance transformation relative to a single-wire dipole. However, we usually have no idea why this is so. Let's start with the general transformation properties and work our way back to the special case with which we are familiar.

Relative to a single-wire dipole, the feedpoint impedance will be transformed upward by the ratio  $R$  according to the following equation:

$$R = \left( 1 + \frac{\log \frac{2s}{d_1}}{\log \frac{2s}{d_2}} \right)^2$$

where the terms  $S$ ,  $d_1$ , and  $d_2$  have the meanings shown in **Fig. 1**.

The log of  $2S$  divided by a wire diameter is a complex quantity that hides some of the consequences of the equation. However, consider that if  $d_1$  and  $d_2$  are equal diameters, then the division of one log by the other log results in a value of 1. Since 1 plus this value is 2 and the square of 2 is 4, then for wires of equal diameter, the impedance transformation ratio is always 4:1 relative to the impedance of a single wire resonant half-wavelength dipole.

In free space the impedance, the resonant impedance of a single wire resonant half-wavelength antenna that is center-fed is between 71 and 72 Ohms for highly conductive materials like copper. Hence, a folded dipole using equal wire diameters for both wires will be about 284 to 288 Ohms.

Now let's note some other aspects of the equation. There are no rules against using wires of different diameter for  $d_1$  and  $d_2$ . The wire diameter values always occur as divisors (below the division line). Hence, the larger the diameter, the smaller will be the resulting log term. Therefore, we get the following guidelines (remembering that  $d_1$  is the diameter of the fed wire):

- 1. If  $d_1 < d_2$ , then  $R$  is always  $>4$ .
- 2. If  $d_1 > d_2$ , then  $R$  is always  $<4$ .

However,  $R$  must always be  $>1$ . That is, 1 is the limit of  $R$  as the ratio of the two log values goes to zero, which would imply an immensely large value for  $d_2$  or an infinitesimally small value for  $d_1$ . The result is that a folded dipole cannot be used to reduce the feedpoint impedance relative to a single-wire dipole.

So far, we have ignored  $S$ . Before taking a log for the numerator and for the denominator of the fraction in the equation, we must divide twice the wire spacing by the wire diameter(s). This results in a different value in the numerator and denominator for each different wire spacing we choose. Hence, the impedance transformation ratio will also change with every change of spacing.

There is one exception to this consequence of spacing. If the two log values result in a value of 1 when we divide one by the other, then the result will always be 4, regardless of the spacing. Hence, for the case where both wires have the same diameter, the feedpoint impedance transformation relative to a single-wire dipole will be 4:1 for any reasonable wire spacing.

There is a limit to how far apart we can place the wires and still have a folded dipole. That limit, however, is considerably farther apart than the limit for having an effective transmission line with confined fields. It also can be a tiny spacing--just enough to prevent a short circuit between the wires.

## Modeling the Folded Dipole

With exceptions that I shall later note, we can use modern antenna modeling software to calculate the properties of folded dipoles of many sorts. For folded dipoles using wires of equal diameter, both MININEC and NEC will yield very accurate results. Remember that the term "modeling" is used in the mathematical sense of calculating antenna properties using equations derived from Poynting Vectors. Hence, the results are very much more accurate

than the small rules of thumb formulae we find in many antenna books.

The trick to modeling folded dipoles is to use many segments. The end wires connecting the parallel wires are a limiting factor. In NEC, we want the segment lengths in the parallel wires to be less than a 2:1 ratio in length to the segments in the end wires. In MININEC, we want to use many segments so that the end corners are not mathematically "cut off" in the calculation. So for the models in this exercise, I shall use a frequency of 28.5 MHz with 110 segments along the length of each parallel wire in MININEC to allow a perfectly centered feedpoint. 111 segments is required in NEC. These models will fall well within the calculation constraints of each program type. However, in all cases, the results will apply to bare wire.

As a test case, let's look once more at the question of spacing. We shall use 0.1" diameter copper wires throughout for our initial tests. This diameter is between #12 and #10 AWG wire. I shall present both NEC-2 and MININEC results for comparison. (For reference, the NEC-2 results are from NEC-Win Plus and the MININEC results are from AO 6.5.)

Let's compare the performance of folded dipoles having 3 different spacing values. A 1" spacing corresponds to the use of ladder line of common commercial sorts. A 4.14" spacing corresponds to one recommendation that we use a spacing of 1/100 wavelength. Finally, a spacing of 13.8" corresponds to another recommendation that we use a spacing of 1/30 wavelength. In the table below,

length refers to the resonant length of the folded dipole, while gain is the free-space gain in dBi. The feedpoint impedance is given in standard series  $R \pm jX$  Ohms terms.

Spacing	Length inches	Gain dBi	Feedpoint Z R +/- jX Ohms
1"			
Mininec	196.56"	2.10	288.0 + j0.0
NEC-2	196.93"	2.12	286.6 - j0.0
4.14"			
Mininec	193.70"	2.10	288.0 + j0.0
NEC-2	194.20"	2.12	287.0 - j0.1
13.8"			
Mininec	186.94"	2.12	287.0 + j0.0
NEC-2	187.40"	2.13	285.8 + j0.0

Note that the two calculating systems yield resonant lengths within about a half inch of each other. As well, the predicted gain is never more than 0.02 dB apart--a truly insignificant amount. Even the resonant resistance values diverge by less than 1.5 Ohms. The systems are certainly consistent with each other.

Nothing in the spacing of the wires of folded dipoles could produce a difference that would be discernable to the most accurate field measuring equipment available today. There is no aspect of antenna theory that can justify a claim that one spacing value will perform better than another.

Private experience might result in other claims. However, private experience is fraught with many variables of construction and maintenance, as well as antenna location variables. However, equivalently well-constructed folded dipoles of different spacing

values will perform equally well when placed in identical antenna settings.

Of course, the actual feedpoint impedance encountered by the builder will vary with the height above ground, just as the feedpoint impedance of a single-wire dipole varies with height. The two curves will show a 4:1 ratio in value, but otherwise be congruent.

Before we leave these folded dipoles, let's note the differences in antenna length. Each antenna was brought to resonance by adjusting its overall length. The wider the spacing, the shorter will be the resonant length. The shortening has two major sources. First, the classic impedance transformation equation does not take into account the end wires. With wide spacing, these wires begin to take up a small part of the antenna length. Second, a 2-wire folded dipole simulates a fat single wire. Just as single-wire dipoles become shorter at resonance with increasing diameter values, so too do folded dipoles with increases in wire spacing.

The handy "468/f" rule of thumb that we use for dipoles is actually only a crude and often inaccurate guide for wire cutting. The resonant length of single-wire and folded dipoles will vary with wire size, spacing (for folded dipoles), and height above ground. If we turn the matter around and cut the antenna according to the old guide, then we can expect different impedance values--including differences in both the resistive and reactive components--as we change wire diameter, spacing, and/or height above ground.

## Wire Size

Let's sample what happens with different wire sizes. We shall keep d1 and d2 the same, but change both wire diameters together. For this set of tests, let's use a spacing of 3" between wires. Again, we shall look at both NEC-2 and MININEC results.

Wire Size	Length inches	Gain dBi	Feedpoint Z R +/- jX Ohms
0.5"			
Mininec	192.10"	2.10	287.0 + j0.0
NEC-2	193.04"	2.13	285.3 - j0.1
#10 AWG			
Mininec	194.54"	2.10	288.0 + j0.0
NEC-2	195.09"	2.12	286.9 - j0.0
#12 AWG			
Mininec	194.90"	2.10	288.0 - j0.0
NEC-2	195.31"	2.12	287.2 - j0.0
#14 AWG			
Mininec	195.16"	2.10	289.0 + j0.0
NEC-2	195.51"	2.12	287.6 + j0.0
#18 AWG			
Mininec	195.63"	2.09	290.0 + j0.0
NEC-2	195.88"	2.10	288.5 + j0.0

All values remain within 0.5% of each other for each set of wire sizes between the two calculating systems. More significantly, there is no perceptible difference in performance predicted for the range of wire sizes.

Although there is a change of resonant length as we change wire size, it is considerably less than the length changes required by differences of wire spacing in the folded dipole. The range of spacing in our tests was 13.8:1, while the range of wire sizes was



12.4:1, comparable ranges. However, the length range was only about 1.5" for the wire size differences, but 4.5" for the spacing differences.

With respect to length and performance, a folded dipole acts very much like a single fat wire. In fact, a single wire dipole will have a length of about 199.8" using 0.1" diameter copper wire to be resonant and have a free space gain of about 2.10 dBi. All of our folded dipoles are shorter, since all are effectively much larger in diameter. To have a resonant length equal to that of the #18 AWG wire folded dipole above (about 195.8"), a single copper wire would need to be just about 1" in diameter. (Reminder: all tests are at 28.5 MHz for consistency throughout this exercise.)

## Antenna Currents and What They Tell Us

One very unhelpful conception of a folded dipole is to think of it solely as some kind of transmission line. As we shall see, there are currents within a folded dipole that we can call "transmission line" currents, but this notion has a very limited application and has misled any number of antenna builders. We have already seen that folded dipoles will perform normally with wire spacing values considerably larger than is optimal for a transmission line (13.8" at 10 meters). That condition will neither void nor abet the interesting currents that we shall later call transmission line currents.

At first glance, a folded dipole operates in ways distinctly unlike a transmission line. For example, in a properly functioning transmission line, at any point along the line, the current

magnitudes will be equal, but the current phases will be opposite, that is, 180 degrees apart. If a resonant folded dipole acted as a transmission line, we should expect to see the same pattern of current values between the two wires.

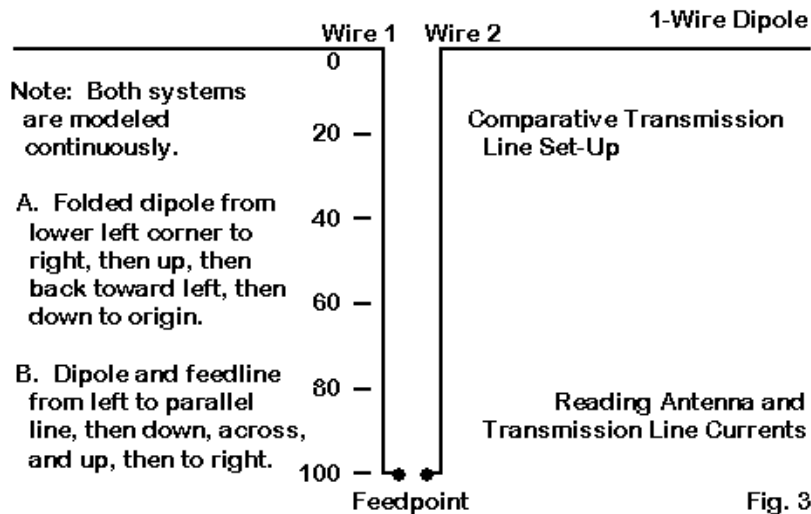
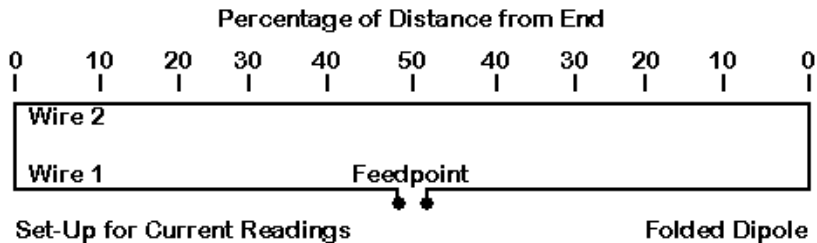

Fig. 3

To demonstrate this, we can use the model on the lower half of **Fig. 3** to derive the currents along the transmission line. A sample every 20% of the way of a line nearly, but not quite, 1 wavelength long is instructive. We shall present two sets of current phase figures for wire #2: onset derived from the modeling convention of continuously developing the model from left to right, the other from using the dipole junction as the starting point for both wires.

Currents Distance	Wire 1		Wire 2	
	Magnitude	Phase	Magnitude	Phase
0%	1.001	- 0.1	1.001	- 0.0/ 180.0
20%	0.419	18.1	0.419	18.1/-162.0
40%	0.758	173.5	0.758	173.5/- 6.5
60%	0.861	-174.6	0.861	-174.6/ 5.4
80%	0.270	- 31.1	0.270	- 31.0/ 148.8
100%	0.999	- 0.2	0.999	- 0.2/ 179.8

The modeling convention that runs the transmission line wires in opposite directions shows essentially the same values for each point on the line. The convention that starts and ends them in the same direction shows the 180-degree out-of-phase condition.

To illustrate what we actually encounter with a folded dipole, let us turn to the upper portion of **Fig. 3**. The markers represent percentages of distance from the outer end of each wire inward toward the center. If we plot the current magnitudes and phases for a typical folded dipole, we end up with an interesting chart. Let's use our #18 bare copper wire folded dipole with 3" spacing as a test case. Current magnitudes are relative to a maximum value of 1.0, while current phases are relative to a feedpoint value of 0.0 degrees. The first current phase figure for Wire 2 is for continuous

modeling so the end 2 of one wire becomes end 1 of the next. The second value presumes a model with both parallel wires starting at the same end of the assembly.

Currents Distance	Wire 1		Wire 2		
	Magnitude	Phase	Magnitude	Phase	
0% (end)	0.256	- 74.5	0.244	-106.4/	73.6
10%	0.463	- 33.8	0.432	-153.0/	27.0
20%	0.682	- 20.2	0.659	-166.5/	13.5
30%	0.855	- 12.4	0.842	-172.6/	7.4
40%	0.964	- 6.2	0.960	-176.1/	3.9
50%	1.000	0.0	1.000	-177.9/	2.1

The chart ends at the antenna center point because the opposite side of the antenna shows virtually identical current values at the prescribed points. Although the current magnitudes are comparable (and would be closer had the wire been without any loss at all), the current phase values show a curious pattern. Corresponding points along the wires show similar absolute current phase values, but they are opposite in sign when both wires are modeled from the same point (e.g., left to right). The pattern is distinctly unlike a transmission line that is acting like a transmission line, even with the far end a short circuit.

A phase pattern similar to the one shown is necessary if the folded dipole is to radiate. Radiation is simply the ability of the fields that result from the current levels at each point along the antenna to expand without limit. This condition is unlike that in a transmission line, where the fields are confined such that radiation is negligible. For that condition to exist, the current magnitudes would have to be equal, and the phase values must be exactly opposite. So we have

a mystery: how can we make sense out of the current magnitudes and phases along a folded dipole?

## The Transmission Line Inside the Folded Dipole

The pattern of current magnitudes and phase angle hides a small tale, one about the fact that a folded dipole has two sets of currents. It is the combination of these two current sets that results in the readings. One set is the radiation currents ( $I_r$ ), which should be (if the tale is correct) quite similar to those on a standard dipole. The other set is comprised of what some call "transmission line" currents ( $I_t$ ). From the modeled current readings, we can separate the two sets. All we need to do is take half the sum of the currents at corresponding points along the folded dipole and we get the value of  $I_r$ . If we take half the difference of the currents on each wire, we arrive at  $I_t$ . Kuecken pointed this out in his book *Antennas and Transmission lines*.

The following table provides the modeled values for a bare-wire folded dipole resonant at 28.0 MHz. The values given are for the fed wire (Wire 1), the "other wire" (Wire 2),  $I_t$  (transmission line current),  $I_r$  (radiation current), and the corresponding current value for a single wire resonant dipole at the same relative distance from the end. The sampled positions are 10, 30, 50, and 80 percent of the distance from one end of the antenna toward the feedpoint in the center. For each entry, the format is current magnitude/phase angle, where the magnitude is relative to a feedpoint current of 1.0, and the phase angle is in degrees relative to a feedpoint phase angle of 0.0 degrees.

Folded Dipole Currents (with Dipole Currents for Comparison)

Position	Folded Dipole				Standard Dipole
	Wire 1	Wire 2	I <sub>t</sub>	I <sub>r</sub>	I
10	0.3740/-59.38	0.3449/+57.79	0.3069/-89.38	0.1878/-4.59	0.1748/-4.44
30	0.5809/-32.42	0.5437/+27.04	0.2973/-89.38	0.4884/-3.77	0.4771/-3.86
50	0.7769/-19.77	0.7506/+14.68	0.4530/-89.93	0.7295/-2.85	0.7228/-3.06
80	0.9649/- 7.61	0.9584/+ 5.63	0.1109/-89.30	0.9552/-1.01	0.9541/-1.60

There is a very good correlation between the folded-dipole radiation currents as derived by the simple summing method and the single-wire dipole currents at the corresponding points along the antenna length. The correlation cannot be perfect, because the simple summing method does not take into account the currents on the end wires of the folded dipole. They are short, but significant. The current magnitude and phase angle both undergo part of their continuing change in those wires. Nevertheless, the differences between the folded-dipole radiation currents and the corresponding currents on a single-wire dipole are small enough that we should expect to discover any difference in the radiation strength or pattern between the two antennas. And, of course, we do not.

Ideally, the transmission line currents should all show a phase angle of -90 degrees. The very slight offset is due both to the end wire phase angle changes and to the resistance of the copper wire used in the test model (composed of AWG #18 wire with a diameter of 0.0403" along with a wire spacing of 1"). Also ideally, the magnitudes should be the same at each point, but are not for similar reasons.

The key element in the transmission line currents is their relative phase angle--almost perfectly -90 degrees out of phase with the source current. Hence, the transmission line currents represent

stored energy rather than expended energy, except for the minute offset from a perfect -90 degrees. As a result, the radiation currents consume all of the RF energy supplied to the antenna in the form of its transformation into indefinitely large expanding electromagnetic fields. Despite energy storage, there is none left over at the end of a transmission.

The existence of transmission line currents within a folded dipole has resulted in a number of erroneous practices based on the use of transmission lines as transmission lines. For example, some folks have proposed that we short the folded dipole at a position equal to a quarter wavelength from the feedpoint outward times the velocity factor of the parallel line used to form the folded dipole. This practice remains to be modeled in NEC-4, which permits the modeler to provide each wire with an insulating sheath with a specified conductivity and dielectric constant.

The first step in considering antennas made from insulated wire is to consider the normal range of velocity factors that apply to antennas (in contrast to those that apply to transmission lines). I began with a 28-MHz dipole that was 204" long and fed in the center of the bare AWG #14 (0.0641" diameter) wire. Then I modeled an identical antenna, but added an insulated sheath with a dielectric constant of 2.5 (about in the middle of the plastics materials range used for wire) and a conductivity of  $1e-10$  Ohms/meter (a very good insulator). I made the insulation about .047" thick--a goodly insulation. Then I re-resonated the dipole at a length of 195.66". This yielded a velocity factor for the insulated wire of 0.959, a typical value for heavily insulated wire.

insulation would have yielded higher values--or longer resonant dipoles. This little exercise gives us something against which to compare a folded dipole composed of insulated wire.

I went through the same exercise with the folded dipole which we examined in its bareness: 2 AWG #18 wires separated by an inch center-to-center. The original folded dipole was 198" long at resonance. Then I covered the wires with insulation that was also 0.47" thick and re-resonated the assembly. The new folded dipole was 191.5" long, for a velocity factor of 0.968, slightly higher than our single wire dipole. In both cases--the single-wire and the folded dipoles, the feedpoint impedance decreased due to the shortening of the wires. The single wire dipole went from 72.8 Ohms bare to 67.7 Ohm thickly covered. The folded dipole dropped from 289.2 Ohms bare to 274.1 Ohms thickly covered.

I next took down the current readings on both wires so that I could calculate the radiation currents ( $I_r$ ) and the transmission line currents ( $I_t$ ) to see if they corresponded to those in the bare wire folded dipole. The calculations yielded the following table.

Insulated Folded Dipole Currents (with Dipole Currents for Comparison)

Position	Folded Dipole				$I_r$	Standard Dipole $I$
	Wire 1	Wire 2	$I_t$			
10	0.3914/-60.83	0.3531/+57.53	0.3198/-89.89		0.1914/-6.57	0.1748/-4.44
30	0.5946/-34.45	0.5435/+25.88	0.2868/-89.87		0.4922/-5.77	0.4771/-3.86
50	0.7845/-21.40	0.7468/+12.52	0.2241/-89.82		0.7324/-4.87	0.7228/-3.06
80	0.9656/- 8.32	0.9546/+ 2.28	0.0889/-89.49		0.9560/-3.05	0.9541/-1.60

Nothing in the new table distinguishes the currents in the insulated folded dipole from those of the bare wire version, with the possible exception of a nearly uniform 2-degree displacement of the



radiation currents. Allowing for the fact that the technique of calculation is approximate--due to reason noted earlier--nothing in the table suggests that we should treat an insulated folded dipole any differently from a bare-wire folded dipole once each is brought to resonance. In fact, both the bare and insulated versions of the antenna show the same gain.

Indeed, the current progression in the insulated wires shows only a single set of curves each side of the feedpoint position, just like the progression in the bare wire version. The upshot is that we need not treat a resonant folded dipole made of insulated parallel transmission line like a transmission line. We can ignore the "transmission line" velocity factor and simply adjust the overall antenna length according to the antenna velocity factor created by the line insulation. The practice of shorting out a folded dipole at the point indicated by the transmission line velocity factor has never shown any evidence of doing anything but shorting out the wires at that point. Finding the resonant length of the folded dipole will be challenge enough.

## Other Impedance Values

The folded dipole is ultimately simply a dipole with an impedance transformation mechanism built into its structure. As a dipole, on its fundamental frequency, it provides all of the performance we expect from a dipole--no more and no less. It tends to have a slightly wider SWR operating bandwidth (when transformed to our feedline value) than a single wire dipole because it acts like a fat wire. But it remains in performance simply a dipole.

The impedance transformation possibilities, however, should not be overlooked. The rules of thumb for transformation ratios that are more than or less than 4:1 can be useful in some contexts. Before looking at potential applications, let's first look briefly at the levels of departure from 4:1 as we systematically vary the element diameters. We shall use the 3" spacing from earlier samples, but this time, we shall run each wire through a range of 0.1 to 0.5 inches in diameter--with one wire increasing as the other decreases.

To perform the modeling for this task, we shall set aside NEC-2. NEC has a known difficulty in dealing with closely spaced wires of different diameters. Fortunately, MININEC has no such limitation and handles the calculation task with ease. We shall list the impedance ratio calculated by the equation, the resultant feedpoint impedance, and then the modeled values. This should give us a quick view as to whether the calculations and models reliably coincide.

----- Calculated -----				----- Modeled -----		
Diameter d1	Diameter d2	Z Ratio	Feed Z R=Z Ohms	Length inches	Gain dBi	Feed Impedance R +/- jX Ohms
0.1	0.5	7.01	498	193.34	2.09	493.0 + j0.0
0.2	0.4	5.09	361	193.20	2.10	363.0 + j0.0
0.3	0.3	4.00	284	193.10	2.10	288.0 - j0.0
0.4	0.2	3.23	229	193.48	2.11	234.0 - j0.0
0.5	0.1	2.58	183	193.96	2.11	189.0 - j0.0

Given that the calculations do not account for the end wires, the coincidence of models and calculations is excellent. Incidentally, in all models, the end wires were sized to match the smaller of the two

diameters involved. Moreover, the absence of any perceptible change of gain in the series of models is notable. However we size the wires in our folded dipole, it gives us dipole performance. To at least some degree, this convention accounts for the very small differences in resonant lengths of the models.

In many beams using the dipole as a driven element, the feedpoint impedance will be far less than 70-72 Ohms. Values from 10 to 50 Ohms are common, although values above 20-25 Ohms are preferred in order to reduce power losses from the accumulation of small resistances at connections. Using a folded dipole with "designer" values for element diameters and spacing, it is possible to raise the impedance to match almost any value higher than the initial feedpoint impedance. One option is to use a low transformation ratio to arrive directly at 50 Ohms. A second option is to use a higher value to arrive at 200 Ohms and then to use a 4:1 balun at the feedpoint to return to 50 Ohms with an accompanying reduction on possible common mode currents on the coax. Although HF use of folded dipole drivers is rare, at VHF they are still very popular.

## **The Folded Dipole as a Doublet**

Before departing the land of folded dipoles, we should at least glance at the potential of the folded dipole as a multi-band doublet. As a sample, we can look at the performance potential of an 80-meter folded dipole. I resonated a 132.85' version at 3.5 MHz. Wire spacing is about 2' and the wire are about 0.3" in diameter. I then checked the patterns and performance on other amateur bands.

Numbers are rounded, since we are looking only for suggestive results.

Frequency MHz	Max. Gain dBi	Feed Impedance R +/- jX Ohms	Pattern No. of lobes
3.5	2.12	287 - j 1	2
7.0	2.27	5 - j 160	2
10.1	3.31	540 - j 750	6
14.0	3.34	25 - j 330	4
18.1	4.71	480 + j 15	10
21.0	4.26	85 - j 530	6
24.9	4.75	550 - j 310	14
28.0	5.03	225 - j 750	8

The gain figures and the number of pattern lobes coincide with numbers we would obtain from a single-wire dipole pressed into multi-band doublet service. What differs is the impedance value set. The difficulty of using a folded dipole on an even harmonic of the band for which it is initially resonated lies in the very low resistive component of the feedpoint impedance. By the sixth harmonic, we have a value that, while low, is well within the capabilities of most ATUs. In contrast, the second harmonic impedance of 5 Ohms is likely beyond the reach--or at least the efficient range--of most ATUs. The 4th harmonic (20 meters in this sample) might well be matchable, depending upon ATU design.

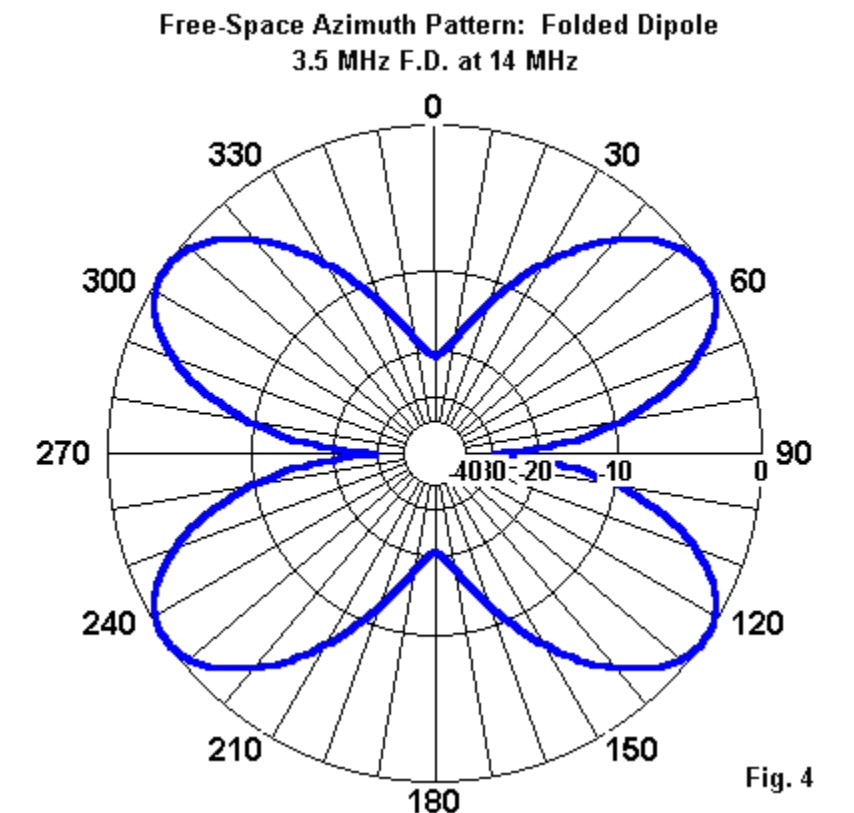

## Free-Space Azimuth Pattern: Folded Dipole

3.5 MHz F.D. at 21 MHz

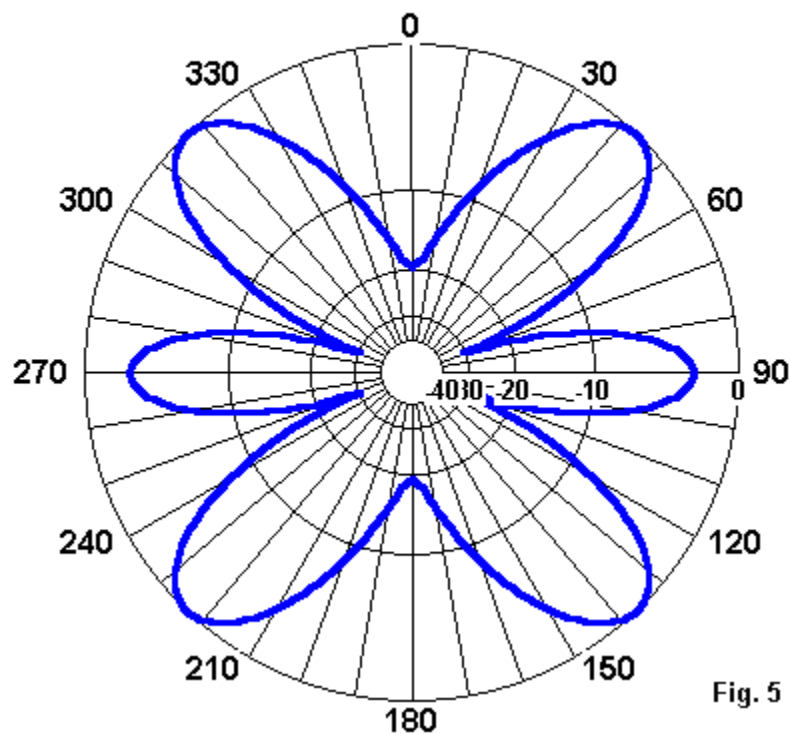

Fig. 5



pattern and the diminishing lobes for the 2-wavelength pattern--for a total of 10 lobes.

Using a folded dipole as a multi-band doublet--with parallel feedline to an antenna tuner--thus becomes a matter of matching rather than of pattern development. Very low impedances may also be lossy, thus reducing performance even if a match can be obtained from a given ATU and feedline length.

For multi-band use, a folded dipole offers no advantage over a single-wire doublet of the same approximate length. Indeed, in the final analysis, perhaps the only reason for using a folded dipole is where the impedance transformation is of special interest, that is, where it may resolve an antenna design challenge. A secondary use would be to offer a path to discharge static charge build-up and thus to reduce one (of the many) noise sources. However, there are other means to this same goal.

Otherwise, the folded dipole performs just like a fat single-wire dipole.

## **Two Variations on the Folded Dipole**

In its standard form, we normally feed a folded dipole at the center of one of its two long wires. Which wire we select for the feedpoint matters only if the antenna performs a "non-standard" impedance transformation, that is, has two wires with unequal diameters. There are variations on this feedpoint position, if the impedance transformation is unimportant. For example, if we are creating a



VHF or UHF J-pole using parallel transmission line as our material, we need not do away with the seemingly unused wire that we separate from the matching section. Instead, we may connect one or both ends to the radiating element that is continuous with the matching section.

There are also two interesting variations of the folded dipole, as suggested in **Fig. 7**. We may call them the end-gapped version and the center-short version.

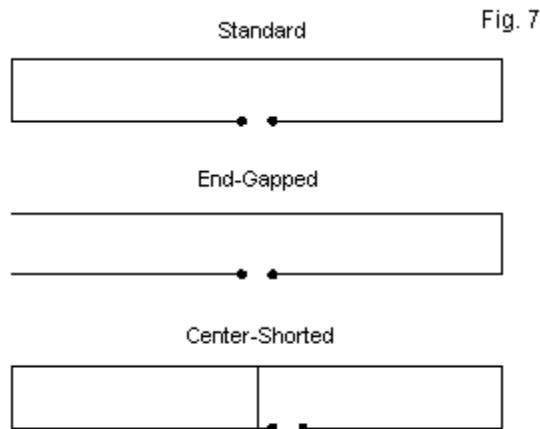

Variations on the Standard Folded Dipole

The end-gapped version of the folded dipole simply omits the end wire, but only one end-wire. A folded dipole is actually two linear dipoles in close proximity--close enough that the wires show

transmission-line as well as radiation currents. The dipoles meet at high-voltage, low-current points as each end. We may open one of the high-voltage region contacts with very little effect on the basic antenna properties, that is, on the radiation pattern and the feedpoint impedance. We might have to readjust the total length of the antenna if a resonant feedpoint impedance is important to a given antenna installation. But we would not change the performance as a radiating element.

The version of the folded dipole with the center short from one long wire to the other has a special application. Suppose that we feed the antenna (very slightly off-center, of course) with a transmission line for which one conductor forms a common or ground lead. We might connect the common lead to the short and the other lead to the long wire. In the process, we do not change the essential performance properties of the folded dipole. However, we do obtain a means of connecting the structure to the support mast in the VHF and UHF ranges. That configuration reduces the likelihood that surges from electrical storms will be conveyed to the equipment.

Although I have run both types of folded-dipole variants through numerous models at VHF, let's set them up using our 10-meter model. The standard version uses two AWG #18 wires spaced 1" apart. With a total length of 198", the model uses 199 segments per long wire. The model of the end-gapped folded dipole simply omits one of the 1-segment end wires, but is otherwise identical to the standard model. The center-short version requires a small set of changes. The long wires each become two wires that meet at the center. Each of these wires has 99 segments. I added a new wire

from one center junction to the other. I then placed the feedpoint or source on the first segment of the wire extending from the short to the end. If my descriptions have been correct, we should expect virtually identical performance from the three folded-dipole variations.

Modeled performance of 3 folded-dipole variations in a free-space environment

Version	Gain dBi	Feedpoint Impedance R +/- jX Ohms
Standard	2.10	289.1 + j 2.6
End-Gapped	2.09	287.8 + j 1.4
Center-Shorted	2.10	288.0 + j 9.3

The only way to tell the antennas apart--besides the obvious visible differences--is to perform a current-sorting exercise on the 3 versions. I did this for some VHF folded dipoles. **Fig. 8** shows the radiation currents along the standard and the end-gapped version of 2-meter folded dipoles. Because the center-short version has connections at both ends, the currents do not drop as close to zero in the end segments as they do with one end of the end-gap version. (Of course, NEC current reports never go quite to zero in a linear wire end segment because the effective position for the current is at the center of the last segment, not its outer end.) Therefore, the center-short and the standard versions of folded dipole have the same radiation-current curves (within limits that are too small to show up in these kinds of graphs).

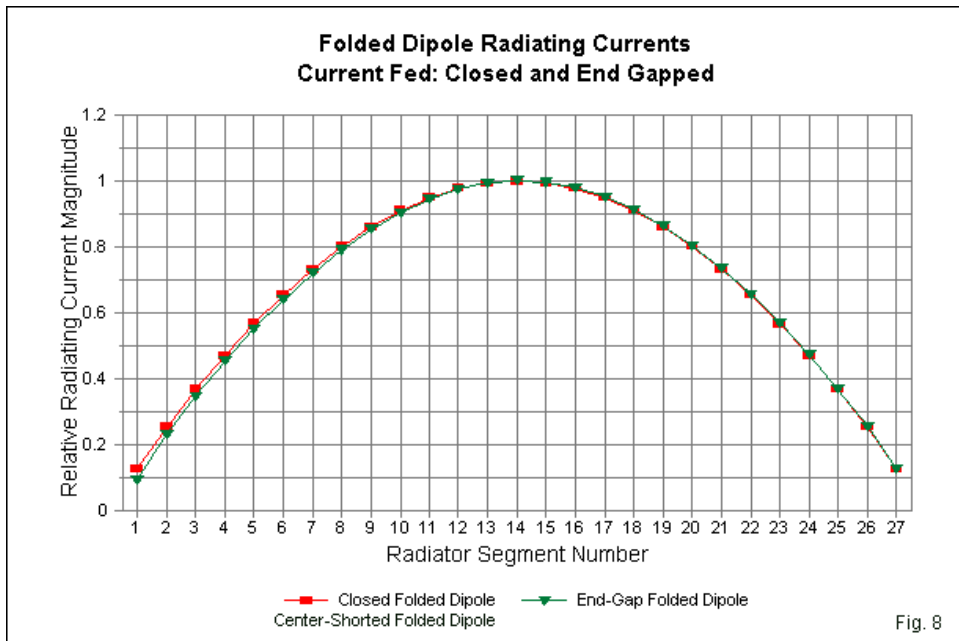

Where the currents for the 3 antennas show significant variation is in the pattern of transmission line currents. Essentially, for all three versions of the folded dipole, the current phase is 90 degrees from the phase of the current at the source or feedpoint. However, the transmission-line current magnitude for the standard folded dipole shows a symmetrical pattern with its minimum at the long-wire center and maximum values at the long-wire ends. **Fig. 9** shows this pattern for the standard folded dipole, using a VHF model. Interestingly, both the end-gapped version and the center-short versions show virtually identical patterns that vary from the

standard version. From the feedpoint toward the open end of the end-gap version or from the shorting bar away from the feedpoint, the transmission-line currents decrease from their feedpoint region value toward zero. At the same time, the current magnitude distribution on the feedpoint side toward the closed end (to the right on the graph) result in higher current magnitudes--in fact about as much higher than the standard version as the low end is lower than the standard version. However, at the center of the antenna, the transmission-line currents have very comparable values.

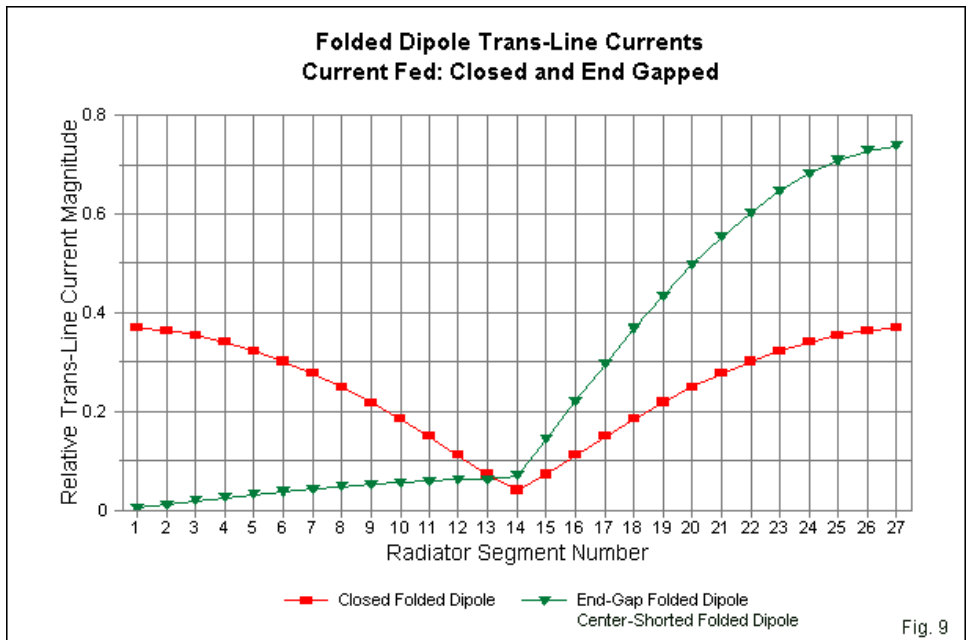

The differences in transmission-line current distribution between standard and variant versions would make a difference only if we end-feed the folded dipole, as in the many variations on the J-pole, and then only in the impedance at the end feedpoint. However, the center-short version of the antenna is normally fed at the center or as close to it as may be feasible. Hence, we would not be able on range tests to tell the difference between the center-short version and a standard version. Equally, the construction difference used for the end-gap version would hide itself in range test, which would show only the radiation patterns and field strengths for any tested version.

You might note that these notes on the folded dipole do not have a section entitled "conclusion." There have been multiple updates to these notes. Each time that I think these notes should end, I learn something new and interesting (at least to me) about folded dipole behavior. I have no good reason to think that my latest additions and revisions should be any different. More on this topic in the next Chapters.

## Chapter 28: The Terminated Wide-Band Folded Dipole

**A**s space for antennas continues to shrink in the present era of smaller urban and suburban yard, hams have begun to turn to 1-antenna solutions to their operating needs. Among the choices for a horizontal antenna that operates on all of the HF amateur bands, the wide-band "folded dipole" (Wbfd) has been gaining popularity. I thought that it might be useful to do some comparative studies using this antenna as a base-line.

The basic Wbfd looks something like **Fig. 1**.

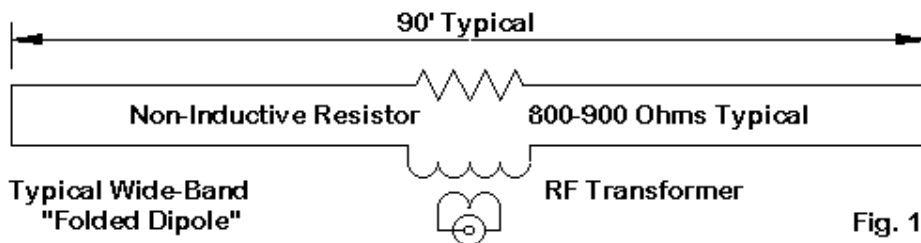

The antenna design appears to be a folded dipole. However, a folded dipole is a resonant antenna, while the Wbfd is designed to operate with a low feedpoint impedance across a wide range of frequencies. Moreover, the Wbfd contains a non-inductive terminating resistor usually located at the point in the loop directly opposite the feedpoint. Normally, the resistor is in the 800-900 Ohm range. This impedance is roughly replicated at the feedpoint. Therefore, builders install a 16:1 RF transformer (either of

transmission-line transformer or normal transformer design) at the feedpoint. The result is a low SWR value for 50-Ohm coaxial cable across the entire frequency range.

For receiving use, such as in SWL service, the terminating resistor can be a low wattage carbon type. For transmitting service, the resistor must have a power value capable of dissipating a fair share of the applied power. The exact amount will vary with frequency, but commercial versions of the antenna are often rated for reduced power at the low end of the operating range, where power dissipation is highest.

Commonly, Wbfd antennas are offered in a 90 to 100 foot length (27-28 meters) for service between 2 and 30 MHz. However, one can build Wbfd antennas in almost any length. Only the effective operating range of frequencies will change.

Since we may also construct doublets of the same length and feed them with parallel transmission line to an antenna tuner, it seemed fair to compare the gain of such a doublet with that of a Wbfd of the same length across the 2-30 MHz range. The model I chose for the Wbfd is 27.2 m (89.24') long, with the wires separated 0.2 m (7.8"). The terminating resistor is 820 Ohms, a standard value used in some commercial models. (Other commercial units use 900 Ohms, often composed of 3 2700-Ohm resistors in parallel.) The wire is #14 AWG. The doublet is a simple length of #14 copper wire exactly as long as the Wbfd.



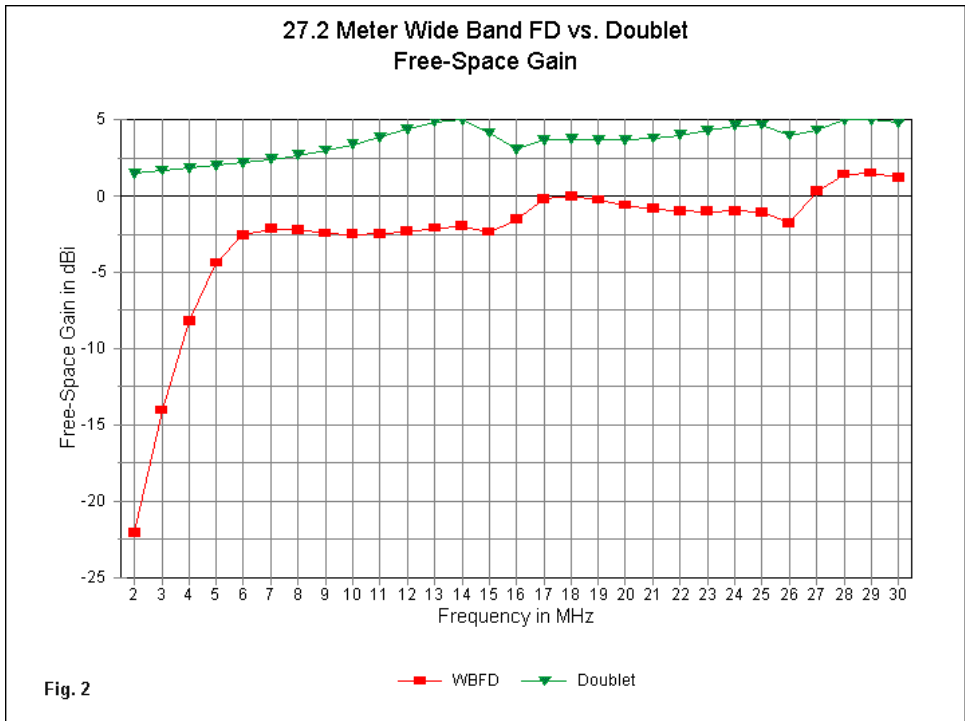

**Fig. 2** compares the free-space gain of the two antennas at 1 MHz intervals from 2 to 30 MHz. Since the elevation angle of maximum radiation will be the same for both antennas for any height above ground and for any ground conditions, any differences that show up in the free-space model will also show up in actual antennas at any height above ground.

Several instructive notes emerge from the comparison of gain in **Fig. 2**. First, the overall average difference in gain between the two antennas is nearly 6.3 dB, with the advantage going to the doublet. If we neglect frequencies below 7 MHz, the average difference diminishes to 5.0 dB. For most of the range of use of the WBFD, then, there is about a 1 S-unit deficit in gain relative to a standard doublet of the same length in the same position.

Second, the WBFD gain curve displays a significant knee--a frequency below which its gain deteriorates rapidly. In the case of the current model, that frequency is about 6 MHz. At or below the knee-frequency, the terminating resistor dissipates more and more of the power. The result is not only a large decrease in gain and higher temperature stresses on the resistor, but as well, very low SWR values at the feedpoint. The knee-effect as the WBFD becomes significantly short relative to the length of a resonant dipole easily accounts for the need to de-rate the antenna relative to transmitting power below a certain frequency.

The deficit in gain is not necessarily a disadvantage for receiving purposes. Modern receivers tend to be equipped with receiving pre-amplifiers that the user can switch in as desired. The gain may range from 10 to 20 dB, depending upon design, and in some receivers may be stepped or variable. Therefore the gain deficit can be largely made up in the lower HF range. Moreover, the basic receiver, apart from pre-amplification, already has excess gain that is rarely used in the lower HF region.

In addition, one of the major problems in reception in the lower HF range, especially with respect to SW broadcast stations, is front-end overload from excessive signal strength. The overload also tends to produce spurious products within the receiver. Hence, reduced gain of the antenna can be in some circumstances an advantage rather than a disadvantage. Combined with the RF attenuator built into many receivers--which may be a single reduction value or stepped--the Wbfd offers a potential for excellent lower HF reception, free of some of the problems that occur with higher gain antennas.

Because the Wbfd is also a closed loop with a terminating resistor, many users claim quieter reception relative to doublets for a given receiver input signal strength. The degree to which this is both true and separable from the freedom from front-end overload is difficult to determine. Nonetheless, SWLs have found the Wbfd a very useful tool for their efforts.

In order to establish that the Wbfd has the same pattern as a doublet of the same length for any given frequency and height above ground, let's look at a couple of sample free-space patterns. For example, see **Fig. 3**.

Free-Space Azimuth  
Patterns: 90' WBFD  
vs. 90' Doublet

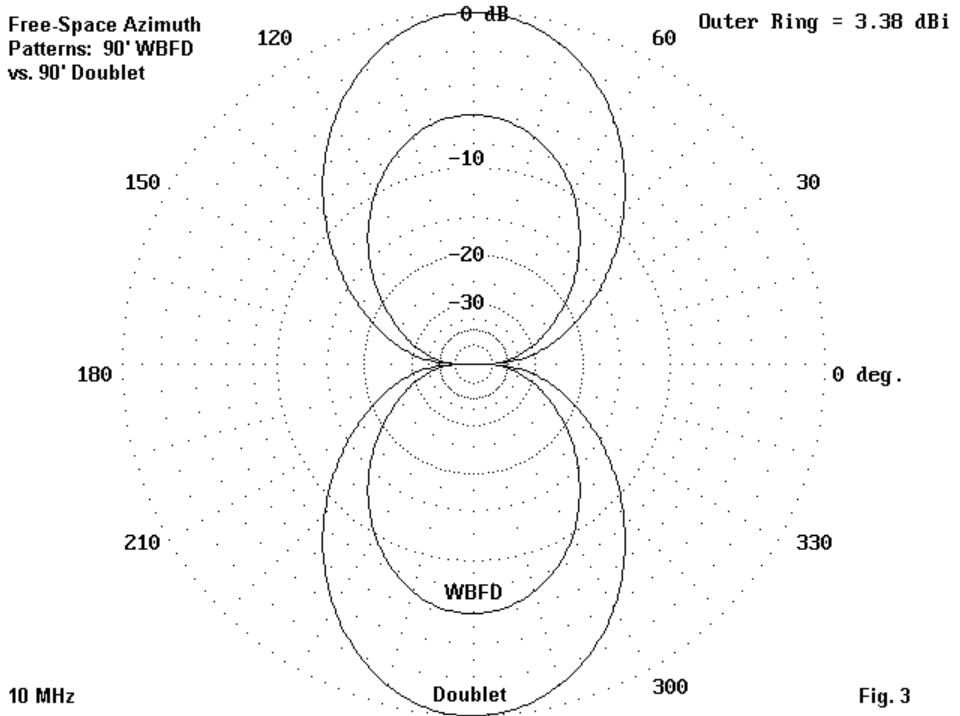

The 27.2 meter WBFD and its comparison doublet exhibit a bi-directional pattern at 10 MHz. The shape of the pattern is identical, with only the 6 dB gain differential separating the two antennas. The -3 dB beamwidth points are also virtually identical. Since the take-off angle (elevation angle of maximum radiation), the reflection from a given set of ground conditions, and other such factors are not dependent upon signal strength, the two antennas would also

show elevation patterns for any equal antenna height that are likewise congruent.

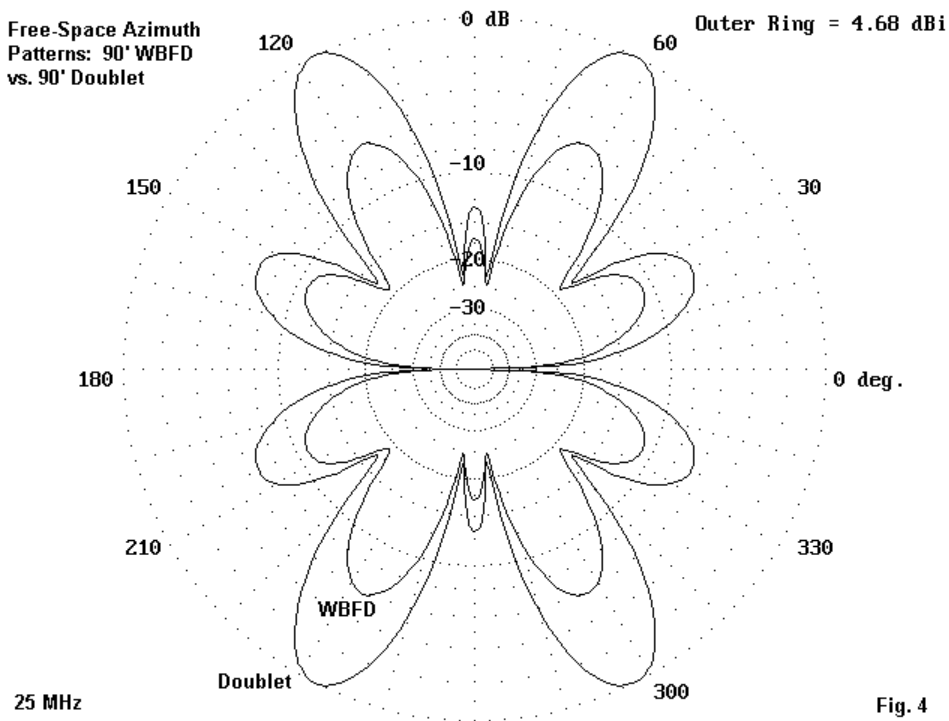

**Fig. 4** shows comparative free-space azimuth patterns for the two antennas at 25 MHz. The WBFD pattern is simply a "mini" version of the doublet pattern, with about a 6 dB difference in strength.

There is an additional point in displaying these patterns. The exact pattern of lobes and nulls in the azimuth readings for a WBFD is identical to that of a doublet. As the length of the antenna exceeds 1.25 wavelength and approaches 1.5 wavelength, the bi-directional pattern at lower frequencies will break up into a collection of lobes and a collection of nulls. Therefore, the antenna is variably selective in its favored directions of good signal strength as one changes frequency. Those who contemplate installing either a doublet or a WBFD antenna need to consider well the patterns at key frequencies of interest in order to orient the antenna for maximum effectiveness.

The antenna type has also been used vertically to provide omnidirectional coverage. However, in this orientation, when the antenna exceeds 1.25 wavelength in over length, the pattern begins to show primarily high angle radiation--exactly the opposite of what one normally desires from the upper HF band. As a result, some installations may use a pair of vertical WBFDs for full low-angle HF coverage.

### **A Note on Knees and Length**

The knee of our 27.2-meter wide-band folded dipole occurs at about the frequency at which a center-fed doublet of the same length would be self-resonant, that is about 1/2-wavelength. We know that a doublet that is shorter than 1/2 wavelength exhibits a feedpoint resistance that declines with length and a capacitive reactance that increases with length.

The knee we observed in the gain of the 27.2 meter WBFD is interesting, since it suggests that we may vary the low frequency gain by changing the length of the antenna. Altering the length, of course, will also change the frequency at which the antenna transitions from a bi-directional pattern into a multi-lobed pattern.

To examine this question, I recreated the 27.2-m antenna model to perform frequency sweeps on both longer and shorter versions. As a sample, I ran a 50-m version and a 15-m version. All of the models used 820-Ohm terminating resistors, #14 AWG copper wire and a spacing of 0.2 meters.

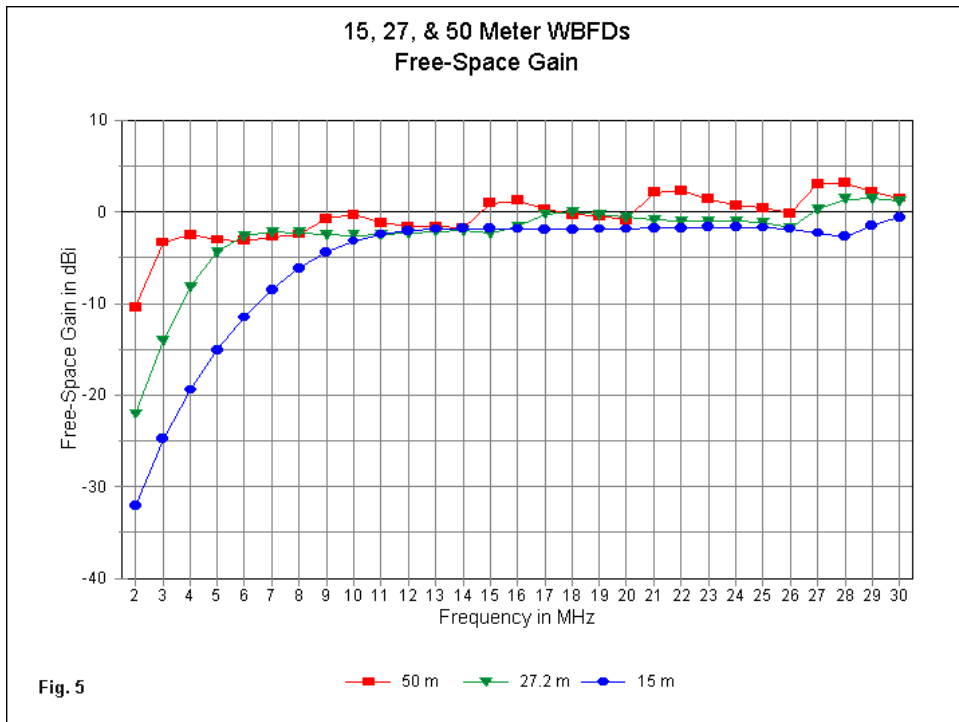

**Fig. 5** compares the gain of the three antennas from 2 through 30 MHz in 1 MHz steps. As suspected, the 50-m antenna reduces the knee frequency to about 3 MHz. In contrast, the 15-m version increases the knee frequency to about 10 MHz. In general, a home builder may interpolate values for the knee frequency for other lengths in the overall range.



The longest of the antenna models shows a mere -10 dBi gain at 2 MHz, a value easily made up by the receiver and only about 1.5 to 2 S-units below the average gain of the antenna. Hence, it is likely to be more satisfactory as a transmitting antenna in the lower HF region. In contrast, the 2 MHz performance of the 15-m version is more than 30 dB lower than the average antenna performance, making it more suitable for higher HF transmitting.

The variations in gain among the curves in the relatively flat region of performance are a function of lobe formation. Maximum gain tends to attach to the major lobes of patterns taken at just higher than integral multiple of a wavelength, relative to antenna length. Minimum gain levels tend to be associated with antenna lengths near the "x+.5" wavelength (where x is an integer) points. When an antenna is 1.5, 2.5, 3.5, etc. wavelengths long, its pattern consists of a combination of emerging and disappearing lobes, all of relatively equal strength. For example, a 1-wavelength wire has 2 strong lobes that are 180 degrees apart and a 2 wavelength wire has 4 strong lobes that are roughly 90 degrees apart. A 1.5 wavelength wire has 6 lobes, as the 1 wavelength lobes diminish and the 2 wavelength lobes grow. Hence, coverage is wide, but at a reduction in maximum strength.

The number of peaks and valleys in the three gain curves is a function of length. The 50-m antenna passes through many more transitions from x wavelength to x.5 wavelength (where x is an integer) across the frequency span than do either of the shorter antennas. Hence, we should expect more highs and lows in the gain pattern.

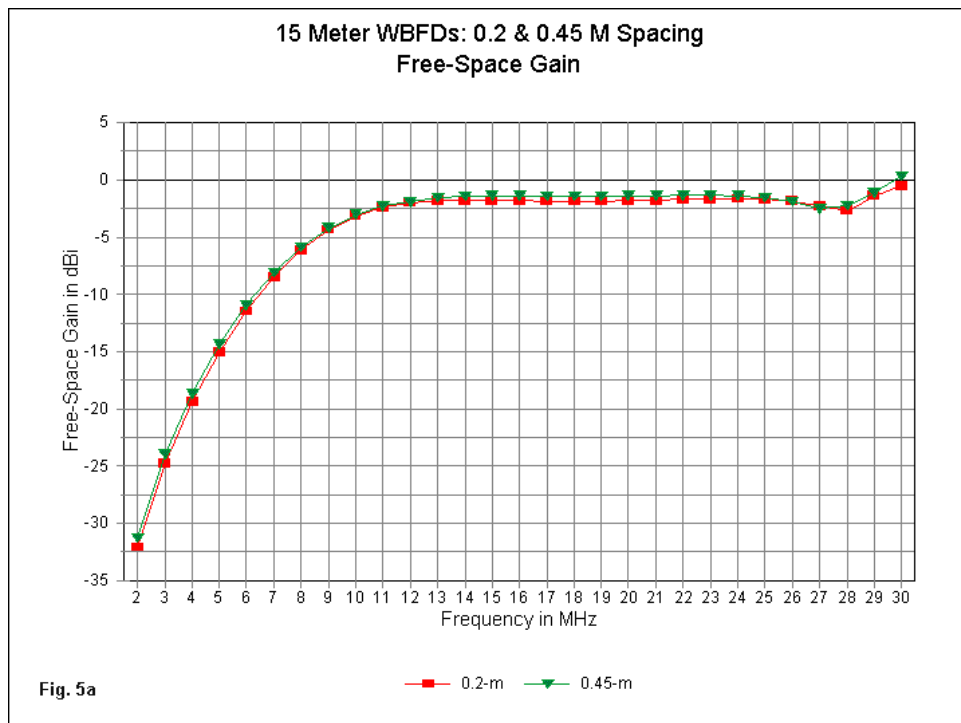

One question posed by various recommended wire spacing in past literature is whether wire spacing makes a difference to performance. **Fig. 5a** provides something of an answer as it compares the gain values for models of a 15-meter long version in 0.2-m and 0.45-m spacing. The gain values are insignificantly different, ranging from 0.2 to 0.4 dB.

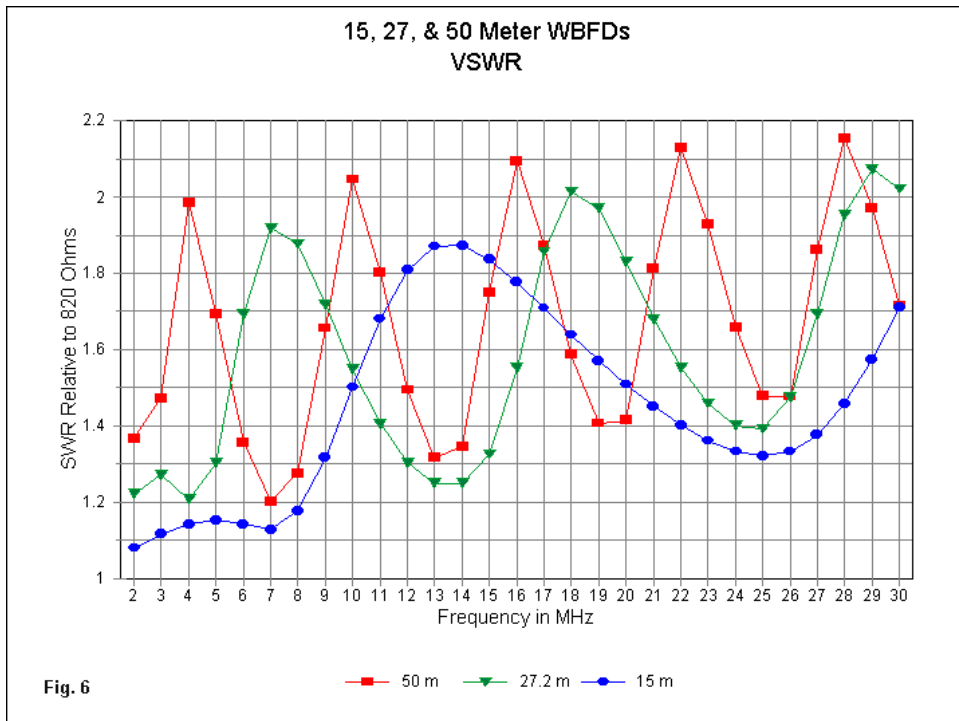

We find that the curve of SWR relative to the value of the terminating resistor will also show similar transitions according to Wbfd antenna length. **Fig. 6** shows the SWR pattern for the three antenna models. If we look at the most dramatic fluctuations--in the case of the 50-m antenna, we discover SWR peaks at  $x+2/3$  wavelength points (where  $x$  is an integer). In contrast, we find SWR minimum values at the  $x+1/6$  wavelength points (where  $x$  is an integer). The frequency span between points relative to the antenna

length is  $1/2$  wavelength. The shorter antennas show the same pattern. However, the pattern is less evident because there are fewer maximum and minimum values to sample.

We may also note that the longer the Wbfd, the higher the SWR excursions for a given value of terminating resistor. However, if we examine the lowest values of minimum SWR and exclude the region below the gain knee of the curve, the corresponding low points in the curve show the longest antenna also to exhibit the lowest minimum value of SWR. In other words, for a given wire size, spacing, and terminating resistor, longer Wbfd's will exhibit a larger range within any given SWR cycle. As we approach the upper HF range, the values may exceed the desired 2:1 SWR limit.

The amount by which a long Wbfd exceeds a 2:1 SWR is not great, but it is noticeable. For receiving applications, mild excursions beyond the 2:1 limit have virtually no effect on the received signal strength for any length of 50-Ohm coax. Some transmitters use automatic power reduction circuitry as the SWR approaches 2:1 (using an internal reverse voltage sensor), and some linear amplifiers begin reducing power at lower levels of SWR in order to protect expensive transmitting tubes.

There are two means of overcoming the potential problems of "high" SWR. Some manufacturers recommend the use of very long coaxial cables. Since the losses in the line increase with frequency, the SWR observed at the station end of the line will be lower at higher HF frequencies than at lower HF frequencies for any given value of SWR at the antenna end of the cable. The result of using

longer coaxial cable runs will then be an SWR curve at the transmitter output that never exceeds 2:1. Compared to the reduced gain already inherent in WBFD design, the added losses of a long cable run are not considered excessive when totaling the overall system gain.

Alternatively, modern amateur transceivers (and those in other services) are routinely (but not universally) equipped with automatic antenna tuner circuitry. Although limited in range compared to a wide-range external antenna tuner, these tuners are certainly adequate to handle the modest SWR values presented by even the longest WBFDs. Hence, the transmitter output circuitry prior to the tuner will show a very low SWR.

## Construction

The decision to use a WBFD involves an evaluation of one's goals in operating or listening. Only with a set of specifications of this order can one decide whether the WBFD will meet the needs. The description of the antenna's advantages and limitations must be set against the operating specifications and along side other potential antennas that are candidates. Then selection becomes a matter of choosing the antenna that does most of the jobs well enough.

If you do decide to use a WBFD, you can purchase one of the commercially made types. B&W (USA), Giovannini (Italy), and others produce these antennas in a variety of lengths. Alternatively, you can build your own.

The antenna proper uses standard techniques of wide-spaced folded dipole construction. You will need twice the length of wire as you determine the antenna length to be. There is nothing critical about the exact length, although the general length will be a function of where you decide to place the frequency that forms the knee separating relative even performance at higher frequencies from diminishing gain at lower frequencies.

Fig. 7

Two Methods of Making Spacers

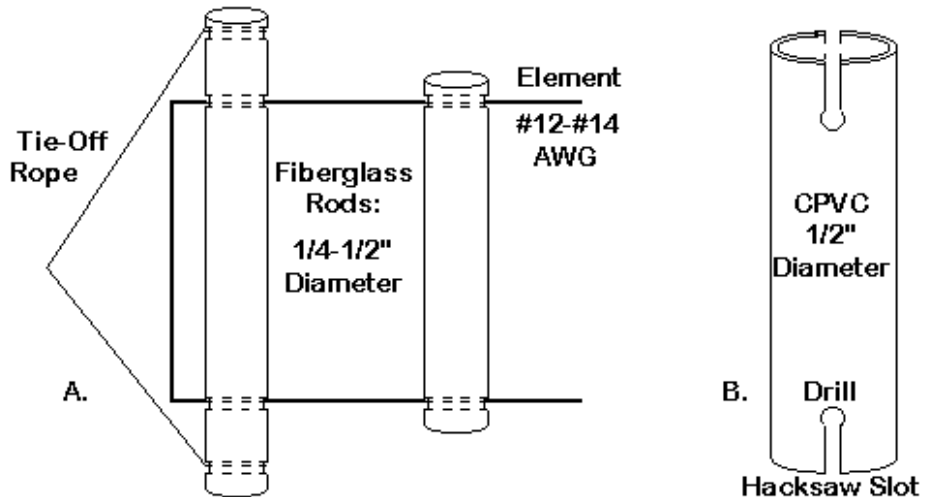

**Fig. 7** shows just 2 of many ways to space the wires along their length. In the 1930s, we might have used wood dowels boiled in paraffin. Today, we have access to a variety of better materials. Part A of the sketches shows fiberglass rods, with holes drilled to

pass the size wire we decide to use. #12 to #14 AWG copper wire (0.06-0.08" or 1.5-2.0 mm) is likely to be the most common choice. The end post can be longer to hold tie-off ropes for the assembly. Fiberglass rods can be purchased from mail order sources. However, local home improvement centers often carry adaptable materials. For example, I recently spotted some 1/2" diameter fiberglass rod under the guise of chimney flue brush extension handles.

Alternatively, I have also had good luck using 1/2" diameter CPVC, a thin-wall form of PVC tubing that replicates copper tubing sizes, shown in Part B of **Fig. 7**. A hacksaw cut in each end leads to a hole drilled to pass the chosen wire size. The wire press fits down the slot and into the hole. If the holes are not deburred, the wires stay put, although the spacers can be repositioned with fair ease.

These are simply two of many ways to make the required spacers. Narrow strips of polycarbonate, acrylic, or Plexiglas would also work. Polycarbonate likely has the best UV resistance of this group. When adapting materials to a new use and environment, it is wise to check the structure every so often to ensure that it is wearing well under the influence of sunlight, precipitation, and temperature excursions. Of course, cut any spacers that you use to the desired length--about 8" (0.2 m) between wire holes for the models examined here. However, this spacing is not very critical.

Locating a non-inductive resistor of sufficient power dissipation is likely to be the chief problem for WBFD builders who intend to transmit with the antenna. Unless you can find a suitable resistor at

one of the surplus outlets, purchasing an antenna may prove economical in the long run, if we add both cost and parts-searching time together. Any value in the 800-900 Ohm range--or even "thereabouts," if a bargain appears--will serve.

Manufacturers use different methods of packaging the resistor into the antenna assembly. Some prefer a total enclosure to weatherproof and bug-proof the resistor. However, one might have to de-rate the resistor's power handling capability under these circumstances. To maximize power dissipation, the resistor can be placed within a tube that is about twice the diameter and about 1.5 times the resistor's length. Air passing through the tube provides cooling, while the tube itself protects against immediate weather impacts. Since the antenna wire and resistor terminals will attach to strips of metal bonded to the tube, the resistor itself is relieved of strain. The down side of this technique is the need to clean out bugs and others debris on a regular basis. However, semi-annual inspection and antenna maintenance is always a good policy.

For receiving-only applications, the resistor problem is much simplified. A series-parallel combination of carbon resistors with a net value of about 820 Ohms is easy to arrange. 1 to 5 watt non-inductive resistors provide the sturdiest construction. The assembly should be mounted in a UV-resistant plastic housing with strong terminals for connecting the antenna wires.

The other challenging component is the 16:1 RF transformer. The builder has two general types of transformers to use: a transmission-line transformer or a standard wide-bandwidth



transformer using a toroidal core. Transmission-line transformers are slightly more efficient for transmitting purposes, although they prefer purely resistive loads. Jerry Sevick, W2FMI, has written extensively on these units, with instructions on how to build them for many impedance transformation ratios. In a pinch, one might place two 4:1 baluns in series.

There are proponents of standard RF transformers using toroidal cores. Doug DeMaw, W1FB, has written on their use, including calculating the power-handling capability of various cores. For receiving-only applications, small cores can be used, and the basic requirements and calculations are described in recent editions of the *ARRL Handbook*, Chapter 6.

Whatever form of RF transformer you use, package it to withstand weather. A sealed UV-resistant plastic box with a correctly placed "weep" hole for moisture drainage is a good choice. Obviously, you will need connections for the antenna wires as well as a coax connector.

### A 3-Wire Version of the WBFD

The WBFD has many variations, and from time to time--as I encounter and model them--I shall add a few notes on them. The first addition to the list is a 3-wire WHFD, outlined in **Fig. 8**, with the 2-wire version shown for contrast.

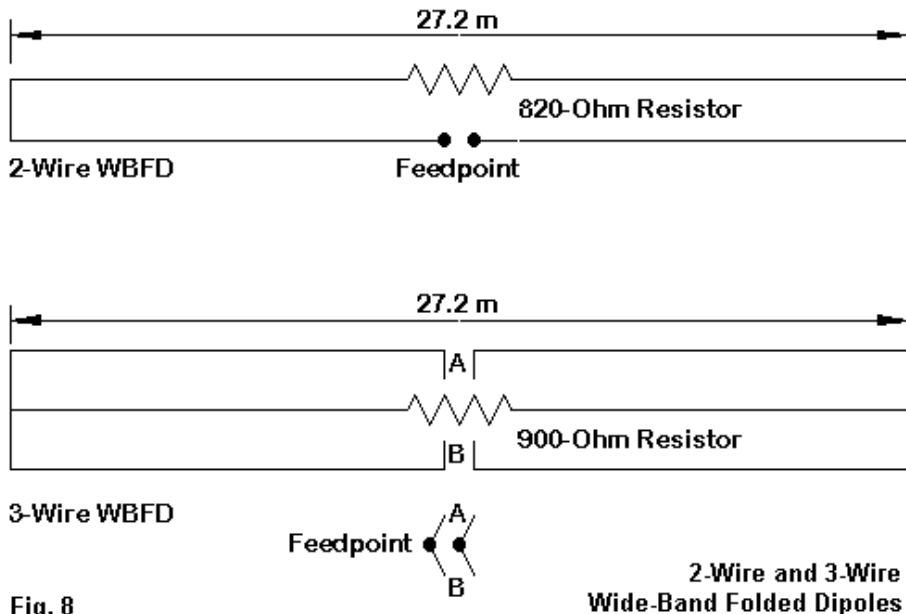

For comparative purposes, I have made each antenna 27.2-m long, with a 0.2-m separation between wires. The 3-wire version places the terminating resistor in the "center" wire and parallel feeds the two "outer" wires. Although the arrangement is shown as a flat configuration, one can, as a variation, create a triangle of wires.

With two parallel-fed wires, the terminating resistor needs to be about 1.5 times the anticipated center feedpoint impedance. Hence, the model uses a 900-Ohm resistor, with 600-Ohms as the expected feedpoint impedance. Of course, the feedpoint

impedance is a nominal value, since the actual resistive component of the impedance will fluctuate continuously above and below that value as we move across the operating span.

In general, the 3-wire version of the WBFD is capable of about 1-3 dB (depending upon frequency) gain advantage over the 2-wire version. The following brief table provides a glimpse at the fluctuations for the 27.2-m antennas. All gain values are for free-space.

Frequency MHz	2-Wire Gain dBi	3-Wire Gain dBi	3-Wire Advantage dB
5	-4.39	-1.62	2.77
10	-2.51	-1.11	1.40
15	-2.42	-0.39	2.02
20	-0.56	+0.74	1.30
25	-1.20	+0.53	1.73
30	+1.28	+2.58	1.30

Despite these fluctuations, the gain curves for the two versions of the WBFD are remarkable congruent, as shown in **Fig. 9**. The dual or parallel feed system of the 3-wire WBFD increases gain by feeding 2 wires, but it does not change the main characteristics of the antenna. Besides the congruence of gain curves, the patterns yielded by the 3-wire antenna differ from those of the 2-wire version only in peak gain, but not in strength. Since the gain increase is marginal, both antennas have patterns that replicate those of a simple doublet (with its widely varying impedance with changes in frequency), but remain smaller, that is, have much lower peak gain values.

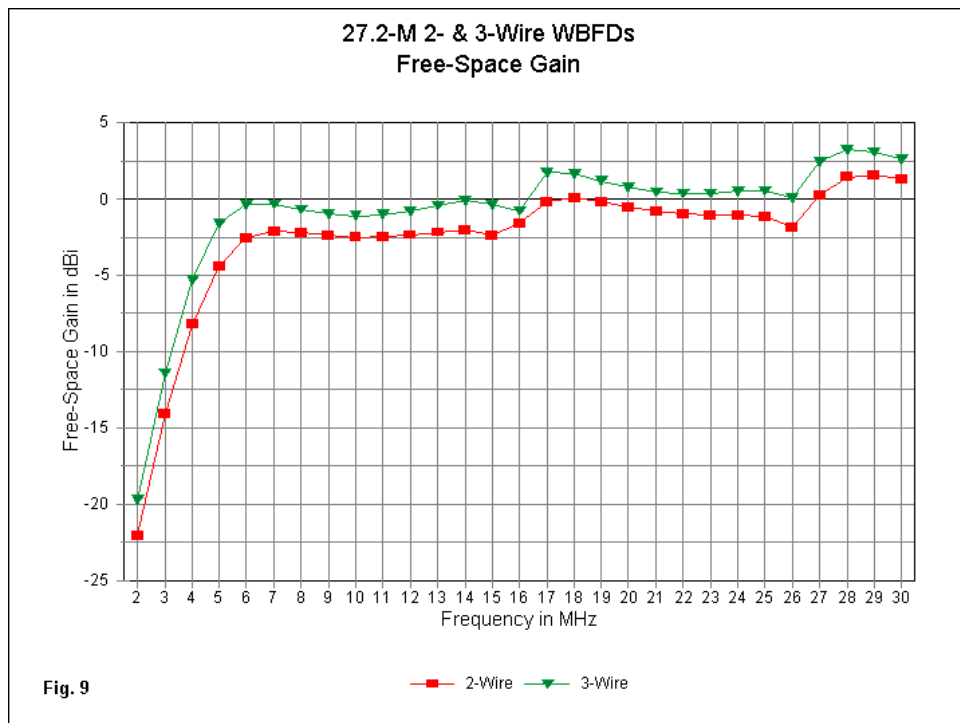

The cost for the small increase in gain is a wider fluctuation in the impedance about a central impedance value. The reactance tends to be somewhat higher than for the 2-wire WBFD. **Fig. 10** shows the comparative SWR curves for the two antennas, with each one using its own reference value: 820 Ohms for the 2-wire version and 600 Ohms for the 3-wire version.

Fig. 10

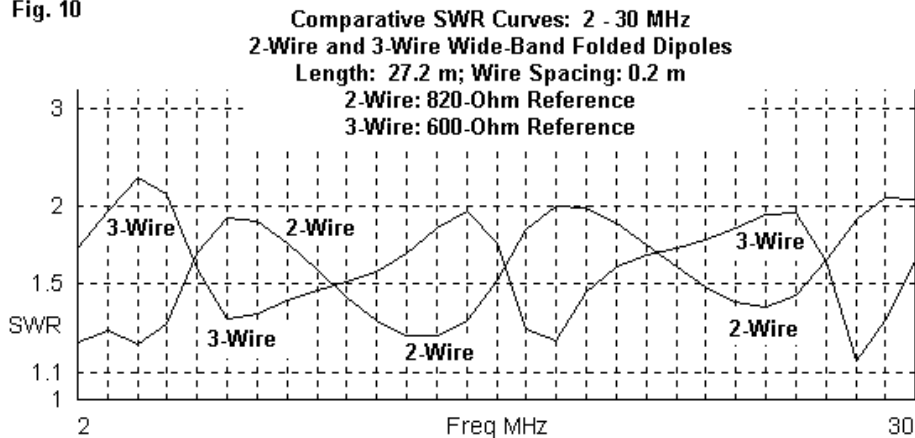

In addition to having higher peak values in the 2-30-MHz span, the 3-wire version curve slopes differ from the corresponding 2-wire slopes. The shallower parts of the curves are on opposite sides of the peaks.

The construction of a 3-wire Wbfd can generally follow the same set of techniques used for the 2-wire antenna, with the separators enlarged to handle the broader plane. The additional wire will increase the weight of the antenna proper by nearly 50%, and center support of the terminating resistor and the feedpoint area is advisable. Short sections of 600-Ohm (or thereabouts) open-wire feedline can create the feedpoint junction. Like the 2-wire Wbfd, the 3-wire version requires a balun system or a wide-band transformer to match a 50-Ohm coax feedline.

WBFDs can be used in inverted-Vee configurations. However, expect a decrease in the broadside gain and some vertically polarized radiation off the ends of the array--just as you would find in a simple doublet. The steeper the angle of the two side of the antenna, the greater will be the radiation off its ends. As the antenna length exceeds 1 wavelength, the patterns may increasingly differ from those of the antenna used horizontally.

### A Common Mistaken View of the Wide-Band Folded Dipole

We may look at the wide-band folded dipole from another perspective, one encouraged by a 1983 B&W patent (#4,423,423). The patent sketch shows shorting wires close to the center of the array. The wires connect the feedpoint to the terminating resistor. In addition, they also connect the inner or feedpoint ends of each wire pair.

The result of this variation is an antenna that is NOT a WBFD. Instead, as revealed by the sketch portion of **Fig. 11**, the new configuration places the resistor in a simple parallel connection with the feedpoint. The wires extending from the junctions of this parallel connection form virtual "fat" single wires to complete what amounts to a center-fed doublet.

Fig. 11

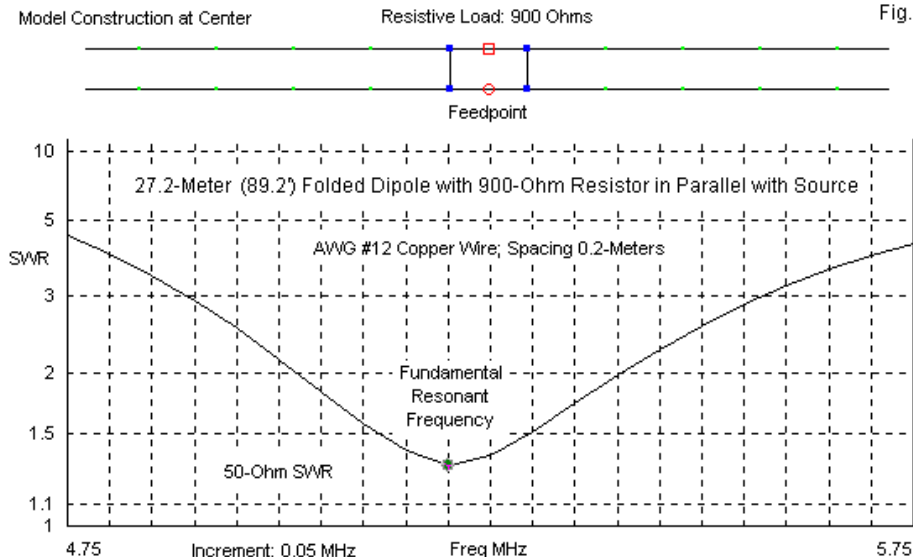

The sketch shows a 900-Ohm resistor in parallel with the feedpoint of the 27.2-m antenna. The SWR curve that accompanies the sketch reveals a property that is unlike the true WBFD antenna: a resonant feedpoint at about 5.2 MHz. The actual reported resonant impedance is about 63 Ohms. The parallel combination of 900 Ohms (the resistor) and 70 Ohms (the typical resonant dipole resistance) is about 65 Ohms.

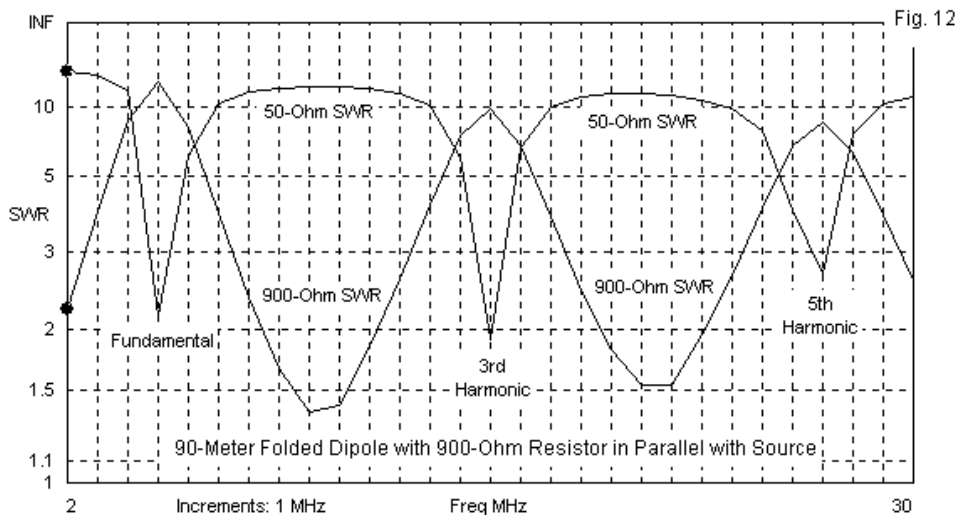

**Fig. 12** provides a set of SWR curves across the 2-30-MHz span that we have used in the examination of the true WBFD. Since the increment between readings is 1 MHz, the 50-Ohm curves do not necessarily show the best SWR values possible. However, the 3 SWR minimum points show that the antenna acts completely normally when treated as a center-fed doublet. The 3 low 50-Ohm SWR values occur at the fundamental, the 3rd harmonic, and the 5th harmonic frequencies for the wire.

The 900-Ohm SWR curve, of course, shows the opposite trend relative to the 50-Ohm curve. Minimum SWR values occur at the 2nd and 4th harmonic frequencies of the wire (between 10 and 11 MHz and again between 20 and 21 MHz). At these frequencies, the



antenna feedpoint impedance would show very high values of resistance and reactance (except for a tiny frequency region where the reactance passes through zero as it changes type). Under these conditions, the 900 Ohm resistor dominates the parallel combination.

We may compare the gain performance of this "faux" WBFD with a true WBFD of the same length. Construction would be identical except for the use or non-use of the shorting wires. At the fundamental and the odd harmonic frequencies, as shown in **Fig. 13**, the new antenna shows higher gain. However, at the 2nd and 4th harmonics, the gain values are virtually the same for both antennas.

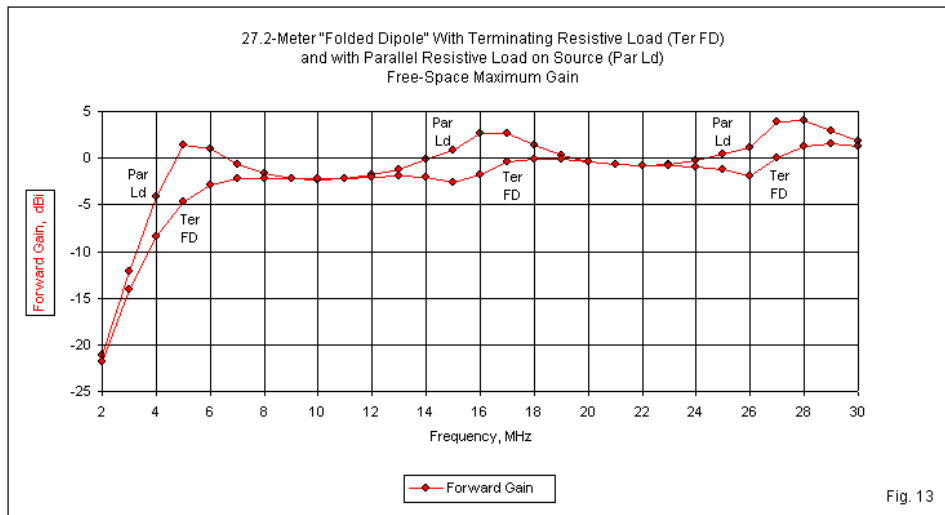

The dominant problem with the faux WBFD is the changing feedpoint requirement as we alter the frequency of operation. A direct coaxial feed is applicable in only 3 narrow frequency regions of the spectrum. Likewise, the 16:1 balun treatment shows equally limited application. Given the feeding limitations, one might well use a simple center-fed doublet with a parallel feedline and a wide-range antenna tuner. **Fig. 14** overlays free-space E-plane (azimuth) patterns for 5.2, 10.4, 15.6, and 20.8 MHz to provide a better performance comparison among the doublet, the WBFD, and the faux WBFD.

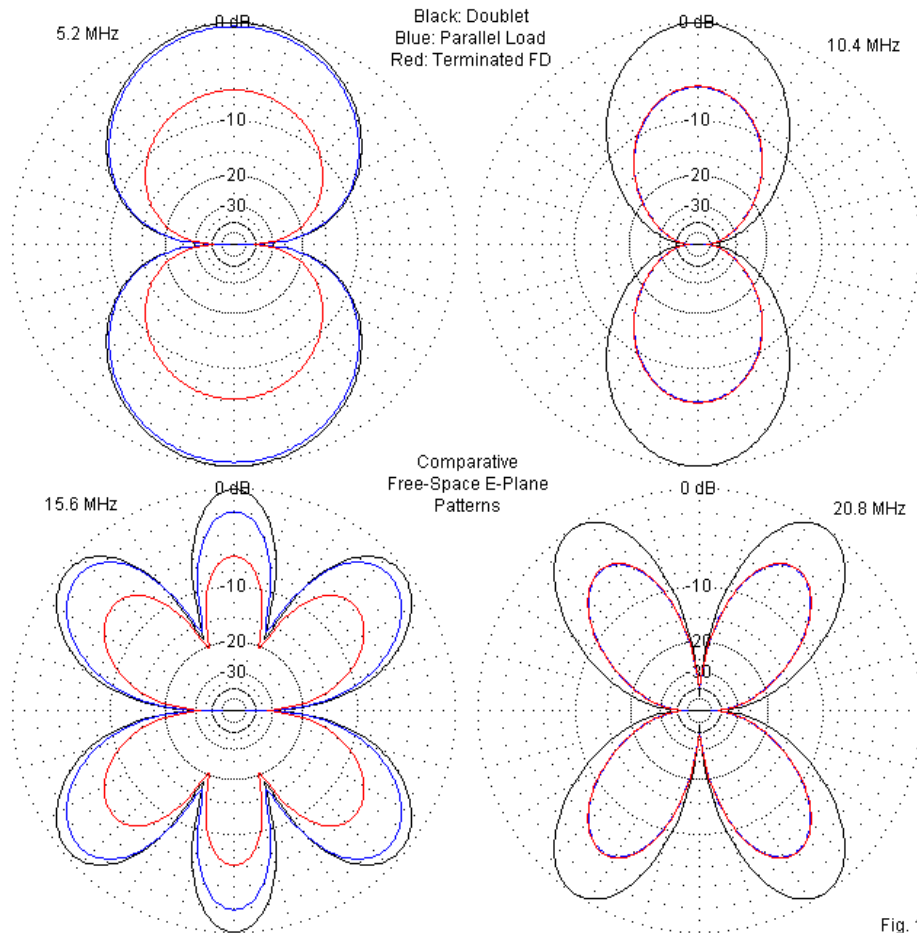

Fig. 14

In all cases, the center-fed doublet exhibits the highest maximum gain. On the fundamental and the odd harmonics, the faux WBFD

is nearly as strong, and the true Wbfd is considerably weaker. On even harmonics, the doublet's gain is very significantly higher than both versions of the folded antenna with a resistor. The consistent aspect of the patterns is their shape. They are perfectly congruent throughout, differing only in the gain value.

The faux Wbfd turns out to be a simple center-fed doublet with a resistor that parallels the feedpoint terminals. Unless one needs an antenna that operates only on even harmonics of the antenna's fundamental length, it offers no useful advantages over the single-wire doublet without the resistor. At many frequencies, its gain deficit can be a distinct disadvantage.

### **What Kind of Antenna is the True Wbfd?**

We have been exploring the behavior of the Wbfd so intently, that we have overlooked an interesting and significant question: What kind of antenna is the Wbfd? We have already shown some reasons why it is not a true folded dipole. But, we have not placed the Wbfd into an appropriate category of antennas.

The answer to our question is both easy and difficult: the terminated folded is a variety of traveling-wave antenna. Entire books have been devoted to traveling wave antennas. See, for example, C. H. Walter, *Traveling Wave Antennas* (1965): a classic and very thorough text on traveling-wave fundamentals for all relevant types of antennas. More commonly recognized traveling wave antennas are terminated long-wires, V-beams, and rhombics.

However, many types of traveling wave antennas require no resistive or other termination.

For our very limited purposes, we may contrast standing-wave and traveling-wave antennas in an over-simplified manner. Consider a transmission line that is lossless or perfect. If we leave the load end of the line without a load in an open condition, the entirety of the energy from the source returns to the source. In a transmission line, we usually view this condition as a system fault, since we obtain no useful work from the source energy. However, if we separate the transmission-line wires to create a doublet, something else happens. We have the energy reaching the line ends and returning. The result is a set of standing waves along the wire. Since the separate-wire situation creates a transducer, we obtain useful work in the conversion of the energy into a field that expands without limit. An ideal antenna would show standing waves that reach the same peak value (however measured) at every peak. As well, all wave minimums would go to zero.

There is no such thing as a perfect standing-wave antenna. Consider a 5-wavelength center-fed doublet composed of lossless wire. It will show a feedpoint current minimum value that is limited by the impedance at the feedpoint. As well, other current minimum points will not reach zero except at the very ends of the antenna. Likewise, the peak values will not be identical along with wire, with the highest peaks occurring closest to and farthest from the feedpoint. The top portion of **Fig. 15** shows a typical (imperfect) standing wave current pattern.

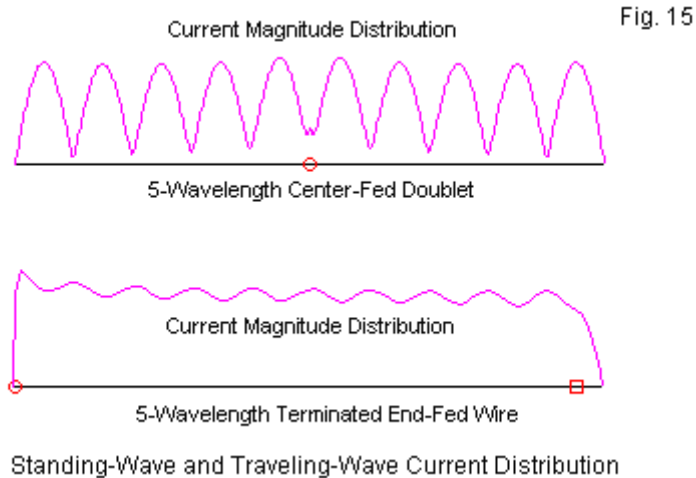

The lower portion of **Fig. 15** shows the current distribution along a terminated end-fed long-wire, one of the simplest traveling-wave antennas. Since we have a terminating impedance, the ideal situation would show a constant current magnitude all along the wire. The termination impedance prevents the return of energy necessary to create standing waves. For a variety of reasons, terminated wires fail to achieve a perfect traveling-wave status. The termination is normally and for highly practical reasons a non-inductive resistor. However, the required impedance turns out to be both complex and finicky. So we only approximate a traveling wave, a basic current level with superimposed standing waves that are small but detectable. (The example shown uses a technique for setting up a traveling-wave long wire described by E. A. Laport in *Radio Antenna Engineering*, pp. 55-58, 301-339 (1950).)

The relevance of these notes to the WBFD and related antennas is straightforward: we may use the current distribution along an antenna to determine in a general way whether an antenna is a standing-wave or a traveling-wave antenna. **Fig. 16** shows the current distribution at 10.4 MHz of several antennas, all 27.2 m long. 10.4 MHz is the second harmonic of the 5.2-MHz fundamental frequency. The arbitrary feedpoint current for all of the antennas is 1.0 (A) with a 0.0-degree phase angle. All current values are relative to this convenient value.

10.4 MHz

Fig. 16

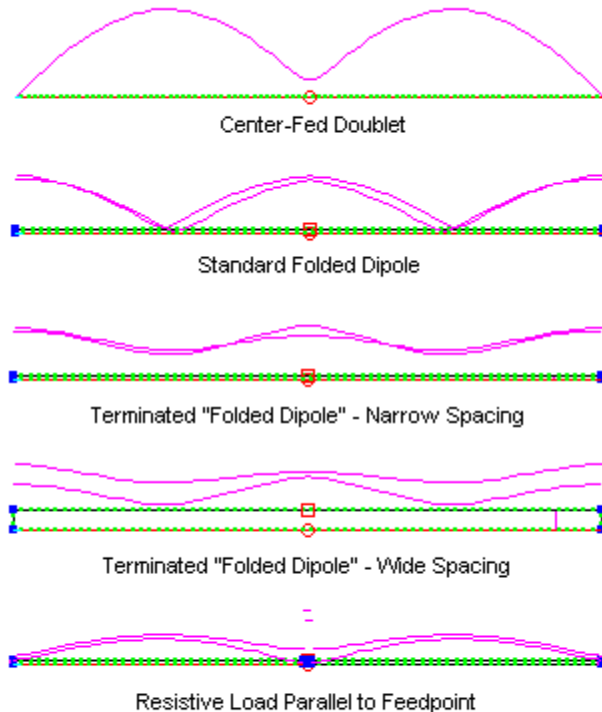

5 Related Antennas at About Twice  
Their Self-Resonant Frequencies  
Relative Current Magnitudes

The center-fed single-wire doublet, a prime example of a standing-wave antenna, shows peak current values about half-way between the feedpoint and the wire ends. The peak currents are over 5



times the feedpoint value, a typical situation for a 1-wavelength doublet. The second antenna is a folded dipole operated at its second harmonic. Its gain is low due to the very low value of the feedpoint resistance (about 7 Ohms). Hence, even the copper wire construction removes almost 3 dB of the antenna's theoretical gain if made from lossless wire. Nevertheless, within these restrictions, the antenna shows the folded-dipole version of a standing wave. Relative to the single-wire doublet, the standing wave is displaced by a quarter-wavelength along the wire due to the fact that folded dipoles show a combination of radiation and transmission-line currents. (For more on this subject, see the preceding Chapter 27.) Note that the current minimums are very close to zero (actually about 0.02 to 0.03 relative magnitude).

The next two antennas shown in **Fig. 16** are alternative narrow-spaced and wide-space versions of the true WBFD. The narrow version spaces the wires by 0.2 m; the wide version uses a spacing of 1.0 m. In the wide version, each current curve is relative in height to the distance from its associated wire. In both cases, the antennas exhibit a standing-wave property, but overlaid on a traveling-wave current value of about .75 relative magnitude. The standing-wave component is about +/-0.30 relative magnitude. Hence, the minimum current level is a bit over 0.45 relative to the feedpoint value. (Values for the 2 versions of the antenna may vary by about 0.03 in relative magnitude from the listed values or about 5%.) The fact that we see the overlaid standing-wave component in current graphs may obscure the basic traveling-wave component of the current distribution until we realize that the current magnitude

never approaches zero and remains well above zero throughout the antenna structure.

All traveling-wave antennas that use terminations dissipate energy in the resistive portion of the termination. Although "sound-bite" wisdom about terminations uses a dissipation value of 50%, we should generally ignore that figure. The actual dissipation in the termination depends on the antenna configuration and frequency of operation. The actual value may be over or under that value by a considerable amount. However, any energy dissipated is unavailable for the radiated field, and hence, we obtain the WBFD gain levels that fall considerably short of comparable fields from the center-fed doublet.

The bottom current distribution pattern in **Fig. 16** completes the survey by including the curves for the faux WBFD. The curves have the general shape of those for the center-fed single-wire doublet and the minimum values approach zero. The parallel resistor does not change the antenna's classification as essentially a standing-wave antenna.

Although the last antenna is indeed a faux WBFD, since it has no relationship except physical appearance to a folded dipole of any sort, I have avoided calling the WBFD a faux folded dipole. The WBFD is not a true folded dipole because it is a traveling-wave antenna. Nevertheless, it retains more than vestigial traces of its folded-dipole origins in the overlaid standing wave pattern on the baseline traveling-wave current level.

## Conclusion

A Wbfd antenna is not for everyone. However, gaining some understanding of its operation, its nature, its advantages, and its limitations may be useful in the process of choosing an antenna--or even simply learning more about what various antenna types can do. The Wbfd has its niche among amateur, governmental/military, and SWL antennas, but that niche is certainly not universal. The government and the military find the antenna useful for ALE (very rapid frequency excursions), and some amateurs are experimenting with these techniques. Within more normal time periods allowed for frequency changes, antenna tuner automation is generally fast enough for most contest environments, and manual tuning suffices for other communications--using a single-wire doublet.

Receiving versions of the antenna can be home built for not much more than the cost of the wire, since the materials necessary for low-power terminating resistors and wide-band RF transformers are low. However, building a transmitting version of the antenna at home may be much more problematical, since parts may be hard to find or hard to fabricate. The alternative, of course, is one of the commercial versions, in an exchange of bucks for bother.

## Chapter 29: Wide-Band Multi-Wire Folded Dipoles

**I**N Chapter 28, I briefly touched on the 3-wire version of the antenna. In this Chapter, I want to expand a bit on that antenna as part of a larger look at multi-wire "folded dipole" antennas using a terminating resistor to extend the SWR bandwidth. In fact, we shall review and expand coverage of 4 antennas: the standard single-wire doublet, the most familiar 2-wire terminated version, the sometimes mis-drawn 3-wire version, and a 5-wire version of the antenna. The goal is to enlarge our understanding of how these antennas work and what features count as advantages and disadvantages of them.

In the process, we shall examine some interesting properties of models of wide-band multi-wire terminated antennas based on idealized models. There are some techniques of model formation that are very useful under certain circumstances. However, if inappropriately relied upon, they can mislead us. As well, we may sometimes collect only partial data from an antenna model and be equally led astray. In this first part of the exercise, let's allow ourselves to be led and see where the path may wind.

The basic antenna will be 27.2 m (89.14') long. **Fig. 1** outlines the single-wire doublet and the common 2-wire version of the terminated antenna having the same length. The sketch does not specify any particular spacing between wires of the terminated antenna. Any reasonable spacing will work from very close to some larger spacing that is still only a small percentage of the total length. The models for this antenna use a spacing of 0.2 m (6.5"),

which is well under 1% of the antenna's length. However, before we close, we shall explore the effects of using the relatively narrow spacing of our initial models and using wider element spacing.

Single-Wire Doublet

Fig. 1

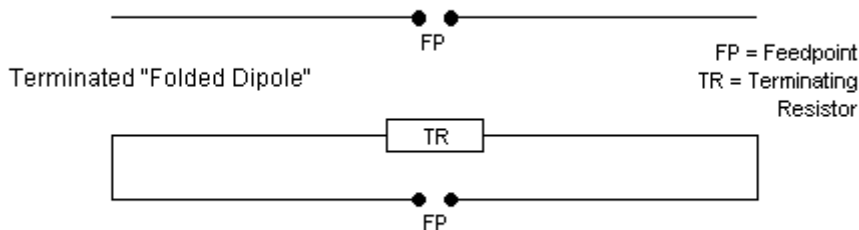

Basic Outlines: Equal Length  
Single-Wire Doublet and Wide-Band Terminated "Folded Dipole"

The TR (terminating resistor) element in the 2-wire wide-band antenna is 820 Ohms in this model. However, values between 800-900 Ohms are most common, and versions exist with resistors ranging from 400 Ohms to 1200 Ohms. The resistor must be non-inductive, ruling out wire-wound power resistors. The resistor inductance would count as a loading coil, adding very significant reactance. In fact, the reactance would climb with frequency and eventually form an effective RF choke. To overcome the problem of finding a desired resistance power value that will not over-weight the center of the antenna, many builders use higher value resistors in parallel. For receiving only, the resistors can be of any power value. However, for transmitting, the terminating resistor must be capable of dissipating about one half of the anticipated power

applied to the antenna. Paralleled resistors must allow for air flow to carry away heat, while at the same time providing protection from the weather in which the antenna operates. Weight, heat, and weather are the three primary enemies of a terminated "folded dipole."

The terminated "folded dipole" only looks like a folded dipole. The wire configuration does not perform an impedance transformation like an ordinary folded dipole without the terminating resistor. As well, the standard folded dipole is a narrow-band antenna, like the simple dipole. In a terminated 2-wire wide-band antenna, the impedance at the feedpoint is a function of the terminating resistor. In fact, the actual impedance at any frequency is a joint function of the termination and the antenna length in wavelengths.

The chief reason for using a 2-wire wide-band terminated antenna is to obtain a satisfactory feedline SWR level across a wide range of frequencies. For the 27.2-m antenna, I shall sample 2 through 30 MHz as a preliminary operating range. **Fig. 2** outlines on the same graph the SWR of a single-wire doublet and of a 2-wire terminated antenna. The most common feedline used with a single wire doublet is parallel 450-Ohm transmission line. Therefore, the doublet SWR curve uses that reference impedance. For all frequencies, the SWR ranges from moderately high to very high. The doublet works by having low line losses, even with fairly high SWR levels, and an antenna tuner in the shack provides the impedance transformation to the 50-Ohm input/output of the transceiver or other equipment. The impedance at the antenna tuner terminals is unlikely to be the same as at the antenna

feedpoint terminals. When the feedpoint impedance and the characteristic impedance of the line are different, the transmission line acts as an impedance transformer for each electrical half-wavelength. Hence, the tuner terminals show an impedance that is a joint function of the original feedpoint impedance, the line characteristic impedance, and the electrical length of the transmission line.

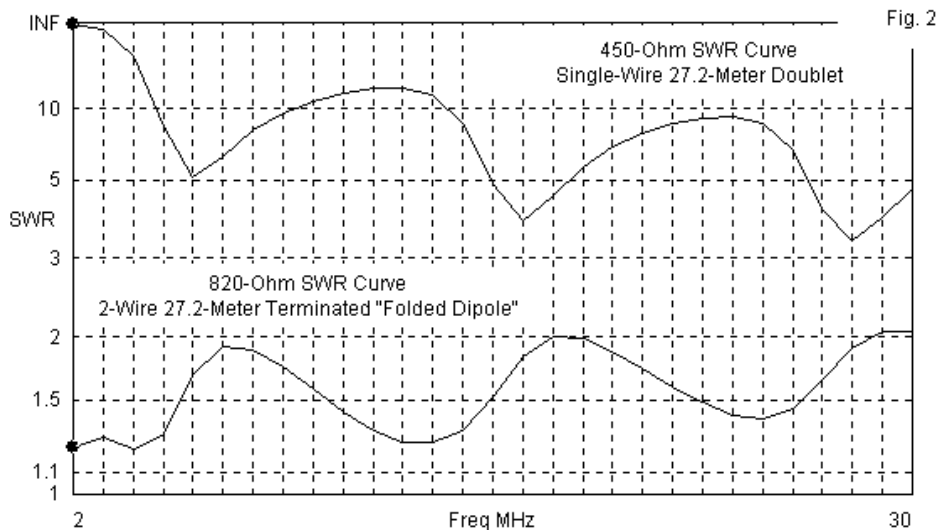

The wide-band 2-wire terminated antenna SWR curve uses 820 Ohms as its reference impedance. The precise value is non-critical so long as it is close to the value of the terminating resistor. The curve in **Fig. 2** shows only minor peaks above the 2:1 level, and those peaks tend to grow with increasing frequency. However, most

versions of the antenna employ 50-Ohm coaxial cable as the feedline. The reference impedance and the cable impedance show a 16:1 ratio. Although a 16:1 balun is possible, many builders employ 2 4:1 baluns (although one of them can be a “unun”). Many balun designs become lossy with rising reactance. Although those losses may be low compared to the power dissipated in the terminating resistor, some antenna makers use a standard transformer to effect the wide-band match. The key factor in any such transformer is to avoid core saturation. See the end of Chapter 6 of the *ARRL Handbook* for a brief characterization of the 2 types of impedance transformers and the basic needs of each kind. A final alternative involving impedance transformation concerns the terminating resistor itself. I have heard of using a 50-Ohm resistor and placing a 16:1 transformer between it and the wire to create the effect of an 800-Ohm terminating resistor.

To take care of any remnant SWR peaks that exceed 2:1 at the junction with the coaxial cable and the antenna and its impedance transforming devices, some wide-band antenna makers recommend very long lengths of coaxial cable. The rationale is simple. Coaxial cable losses are real, but will be relatively small--even at 30 MHz--compared to the losses due to the dissipation of applied energy in the terminating resistor. Hence, the use of a long cable is operationally insignificant relative to antenna performance. Moreover, the long cable will usually prevent the triggering of fold-back circuitry that protects the final amplifier in the presence of excessive SWR values.



The 3-wire terminated wide-band antenna is an extension of the 2-wire version. The general claim associated with the 3-wire version is higher gain with equal or better SWR curves. We shall eventually examine the gain claim in some detail. For the moment, we may simply see the schematic outlines of the 3-wire wide-band antenna in **Fig. 3**. For the sample model, the terminating resistor is 900 Ohms.

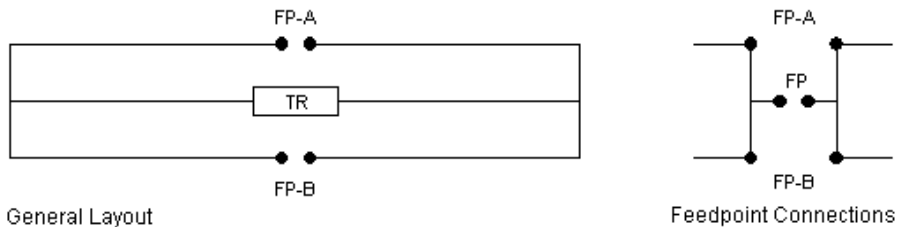

Outline: 3-Wire Wide-Band "Folded Dipole"

Fig. 3

The right side of the sketch shows the parallel connection of the antenna feedpoint terminals on the 2 non-terminated lines. This configuration yields proper connections for wide-band service. In some sketches (that do not pretend to be electrical schematic diagrams of the antenna), I have seen simplified connections that can mislead the home builder. The sketches seem to show the center point of each non-terminated wire as comprising each side of a proper series feedpoint. For normal installations with no special components, this system will not work. **Fig. 4** shows why.

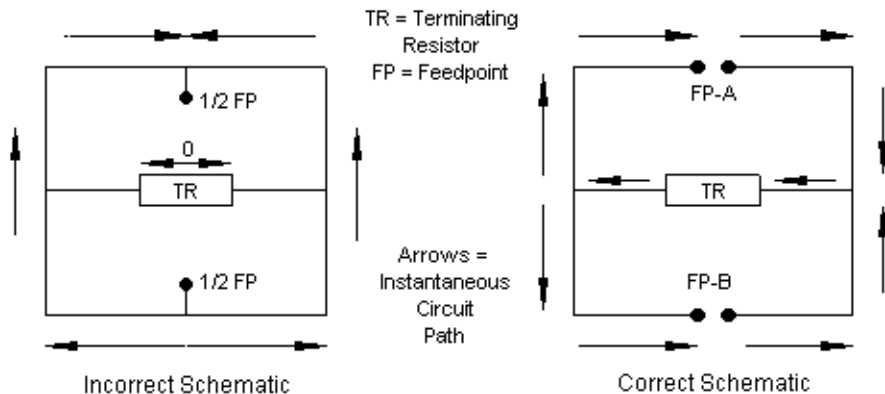

Correct and Incorrect Ways to Schematically  
Draw the Feedpoint System of the 3-Wire  
Wide-Band "Folded Dipole"

Fig. 4

The left side of the sketch shows the circuit path of the antenna if we join the center points and connect the source between them. The path leads at any instant away from one connection and toward the other through 2 parallel paths. At the ends of the antenna (obviously not drawn to scale in **Fig. 4**), the junctions with the line carrying the terminating resistor at its center have equal voltage. The net voltage drop across the resistor is therefore zero, and that component has no function in the antenna, when set up in this way. In fact, models created using this system show no difference of pattern, impedance, or termination-line current for any value of resistor, from zero to very high.

The system on the right provides the correct path for the terminating resistor to do its work. When I modeled the antenna, I used the terminating resistor line as a center point. Then I set up the fed lines 0.2 m away from the center line. The need to connect the feedpoints in parallel presents an interesting geometry challenge if we model the antenna using only wire entries. However, there is a simple technique of connecting feedpoints in parallel that may be useful to newer antenna modelers. The following model description from EZNEC may illustrate the general technique.

```

EZNEC/4 ver. 4.0

3-Wire Wide-Band FD                      6/24/05    9:28:16 AM

----- ANTENNA DESCRIPTION -----

Frequency = 12 MHz
Wire Loss: Copper -- Resistivity = 1.74E-08 ohm-m, Rel. Perm. = 1

----- WIRES -----

No.      End 1      Coord. (m)      End 2      Coord. (m)      Dia (mm)  Segs
      Conn.      X      Y      Z      Conn.      X      Y      Z
1      W4E2      -13.6, 0, 15      W2E1      13.6, 0, 15      #12  69
2      W5E1      13.6, 0, 15      W3E1      13.6, 0, 15.2    #12  1
3      W2E2      13.6, 0, 15.2    W4E1      -13.6, 0, 15.2    #12  69
4      W3E2      -13.6, 0, 15.2    W7E2      -13.6, 0, 15      #12  1
5      W1E2      13.6, 0, 15      W6E1      13.6, 0, 14.8    #12  1
6      W5E2      13.6, 0, 14.8    W7E1      -13.6, 0, 14.8    #12  69
7      W6E2      -13.6, 0, 14.8    W1E1      -13.6, 0, 15      #12  1
8      -0.1, 1, 15      0.1, 1, 15      #20  1

Total Segments: 212

----- SOURCES -----

No.      Specified Pos.      Actual Pos.      Amplitude      Phase      Type
      Wire # % From El % From El Seg      (V/A)      (deg.)
1      8      50.00  50.00  1      1      0      v

----- LOADS (R + jX Type) -----

Load      Specified Pos.      Actual Pos.      R      X
      Wire # % From El % From El Seg      (ohms)      (ohms)
1      1      50.00  50.00  35      900      0

```

```

----- TRANSMISSION LINES -----
No.      End 1 Specified Pos End 1 Act  End 2 Specified Pos End 2 Act  Length      Z0      VF
Rev/Norm
Wire #   % From El % From El  Wire #   % From El % From El  (m)        (ohms)
1        3         50.00   50.00   8        50.00   50.00   0.01       500      1      N
2        6         50.00   50.00   8        50.00   50.00   0.01       500      1      N
Ground type is Free Space

```

Wire 1 is the terminated line, as indicated by the Load entry. Wires 3 and 6 are the lines with the feedpoints shown in the original antenna sketch. Wires 2, 4, 5, and 7 are the end-connecting wires. Wire 8 is the feedpoint wire segments, as indicated by the Source entry in the description. The wire is only a meter away from the main wires, but it is so short and thin (0.2 m by AWG #20) that it does not materially affect the performance figures of the main wires.

Now note the 2 transmission-line entries. Each runs from the center of one of the fed wires to the new distant source wire. A transmission line is not a physical or radiating wire within a model. It is only a mathematical construct factored into the model after completion of basic matrix calculations. In fact, the physical or geometrical distance between the source wire and the wire segment at the other end of the transmission line does not define the line length. Instead, we specify the line's electrical length (as well as the characteristic impedance) when we enter the transmission line data, and calculations use this length. Note that the length for each of the 2 lines is 10 cm (about 4"). We could have made it even shorter (down to something like 1e-10). But 4" effects virtually no impedance transformation down the line. In fact, the specified characteristic impedance (500 Ohms) is also non-

critical, and changing it by a few hundred Ohms creates virtually no impact on the reported final feedpoint impedance.

The technique of using near-zero lengths of transmission line to connect wires in parallel is very useful to many types of models that connect feedpoints in parallel. NEC-2 and -4 have some limitations with very shallow angles that are often involved in these kinds of connections. The wire surface can penetrate the center third of the other wire segment at the junction, creating errors in the current calculations. The transmission-line technique avoids those problems. As well--and especially apt to this case--the technique avoids involving us in extra wires, odd changes of wire direction, and the inevitable expansion of the model size as measured by the number of segments. Nevertheless, we must recognize that our models are idealizations. Any implementation of a 3-wire wide-band terminated antenna will necessarily have leads to the common feedpoint at which we find the impedance transformation device. Whether the ease of modeling with the TL-based parallel connections serves us well or ill we shall not determine until we explore Part 2 of the exercise.

I used a similar system to parallel-connect the feedpoints of 4 wires surrounding a terminating resistor wire. The 5-wire wide-band terminated antenna appears in schematic form in **Fig. 5**. The schematic does not attempt to replicate the modeled physical structure, but is handy to represent the 4 paralleled feedpoints. The sketch on the right gives an end-on view of the antenna. The two new wires are at right angles to the existing wires, forming a cage

of sorts around the center wire. The square represents the terminating resistor at the center of the center wire.

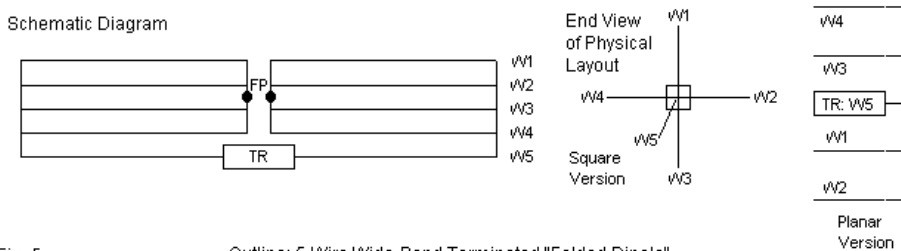

Fig. 5

Outline: 5-Wire Wide-Band Terminated "Folded Dipole"

As an alternative version, I modeled the 5-wire wide-band terminated antenna as a planar construct. The far right sketch shows the general idea, but not at all to scale. The fed wires lie in a single plane with the termination wire, 2 above and 2 below the terminating resistor. The model uses the same spacing--0.2 m-- between each wire. As well, the model uses the same short transmission-line technique to connect the feedpoints in parallel. In both versions of the 5-wire antenna, the terminating resistor is 800 Ohms. The planar version seems to show slightly better performance than the square version, so I shall use it for the initial data-gathering exercise.

We can now examine the SWR bandwidths of the 2 expanded versions of the wide-band terminated antenna. **Fig. 6** shows the 500-Ohm SWR curve for the 3-wire version and the 300-Ohm curve for the 5-wire version. The 3-wire antenna shows a very well-behaved SWR curve, with an excursion above 2:1 only between 3

and 4 MHz, below the frequency that I shall eventually recommend as the minimum usable frequency for all of these 27.2-m antennas. However, note a change relative to the 2-wire antenna. For the smaller antenna, the center of the feedpoint impedance excursions occurs at about the same impedance as the terminating resistor. However, the SWR reference for the 3-wire antenna is only about 55% of the value of the terminating resistor (500 vs. 900 Ohms).

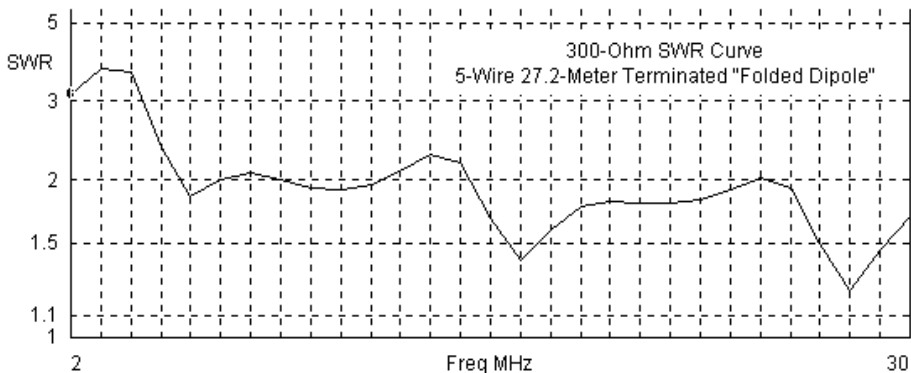
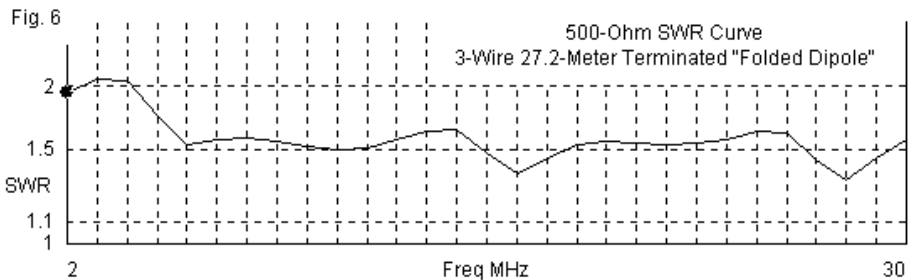

The curve for the planar 5-wire version of the wide-band array is less well behaved, with 3 humps above the 2:1 SWR level. Although the terminating resistor is 800 Ohms, the reference level for the SWR is down to 300 Ohms, or under 40%. As we drop the necessary reference impedance, due to having more wire feedpoints in parallel, the reactance at any given frequency plays a larger role in determining the SWR. Hence, the lower the feedpoint reference level, the more likely we are to find higher SWR levels.

The 3- and 5-wire antennas shows interesting parallels between the curves, with peaks near 3-4, 7-8, 14-15, 20, and 25-26 MHz. In this respect, the curves are only vaguely similar to the 2-wire version of the antenna, despite the similarities in the terminating resistor values (800-900 Ohms). For SWR bandwidth, either the 2-wire or the 3-wire versions of the antenna show the more promise. While the 2-wire antenna requires a 16:1 impedance transformation for use with 50-Ohm coaxial cable, the 3-wire antenna requires a 10:1 transformation. The 5-wire version sets up a conflict: the reference impedance requires a 6:1 transformation, a value within construction limits for a single balun. However, the SWR excursions suggest a considerable reactive component that may induce higher losses in at least some balun designs.

If SWR bandwidth were the only consideration, then the simplicity of the 2-wire antenna would dictate its use. The addition of more wires complicates the antennas structure and adds weight, especially in the separators needed to keep the antenna from corkscrewing in the wind. So our final question is whether we obtain



any advantage in turning to a more complex wide-band terminated "folded dipole."

The brief answer is a qualified "yes:" we obtain more gain from adding fed wires to the system. The following table illustrates the gain advantage of adding wires.

Comparison of Maximum Free-Space Gain Values of 27.2-m Antennas at Selected Frequency	6 MHz	12 MHz	18 MHz	24 MHz
Antenna	Free-Space Gain dBi			
1-Wire Doublet	2.18	4.37	3.73	4.59
5-Wire Wide-Band	1.32	0.19	2.78	1.56
3-Wire Wide-Band	-0.36	-0.80	1.64	0.50
2-Wire Wide-Band	-2.59	-2.36	0.04	-1.07

For each of the selected frequencies in 6-MHz increments, the larger the number of wires in the wide-band antenna, the higher the gain. In some cases, the 5-wire antenna comes within 0.9 dB of matching the non-terminated doublet, while in other instances, the differential is almost 4.2 dB. However, by the time we get down to 2 wires in the terminated antenna, the gain differential can be as much as 6.7 dB. **Fig. 7** provides maximum free-space gain curves for all 4 antennas from 2 through 30 MHz in 1 MHz intervals.

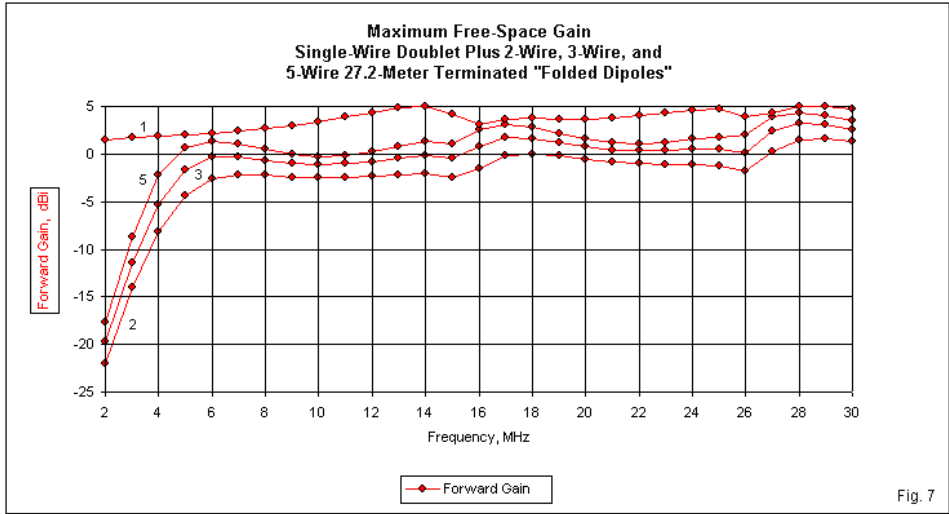

The curves show several items of interest. First, the more wires in the array, the greater the variability of maximum gain across the entire scanned range. Despite the higher variability of gain in the 5-wire curve, the gain curves for the 3 terminated antennas show a tight parallelism. On a few of the sampled frequencies (1-MHz increments), the 5-wire antenna comes close to equaling the gain of the doublet used as a standard. However, a 3-dB differential is more common. The 2-wire antenna averages about 5-6 dB differential from the doublet values. Note that all of the models set up their wires parallel to the Z-axis, so the gain reports are taken in the X-Y plane or broadside to the plane of the wires.

More significant is the fact that all 3 terminated antennas show a knee in their curves. Below the knee frequency, the gain drops very rapidly. The knee frequency occurs when the antenna passes below an electrical  $1/2$ -wavelength at the operating frequency. Broadly speaking, the knee for the 27.2-m antennas occurs around 5.5 MHz. The larger the antenna, the lower the knee frequency as the multitude of wires act like a fatter single wire. However, below the knee frequency, the 5-wire antenna loses gain faster than the simpler wide-band versions. Although the doublet exhibits quite reasonable gain below the knee frequency, at a certain point, the gain may be unobtainable in practical terms. As an antenna falls to  $3/8$  wavelength or shorter, the reactance climbs rapidly while the resistance sinks to a very low value. The combination will show considerable line loss, even using low-loss parallel transmission line, and the antenna tuner may have difficulties in effecting a match to the values that appear at its terminals.

To obtain a better view of comparative gain with the recommended operating range, we may omit the region at and below the knee from our graph. **Fig. 8** provides the same data as **Fig. 7**, but the frequency range restriction expands the Y-axis. With a knee at about 5.5 MHz, the recommended operating range for the 27.2-m antennas is about 6-30 MHz. For operation down to 2 MHz, I would suggest an antenna (of any of the 4 types) that is about 71-72 m (about 235'). Since we are not seeking precise resonance, the exact length is not important so long as the antenna is at least  $1/2$  wavelength at the lowest operating frequency.

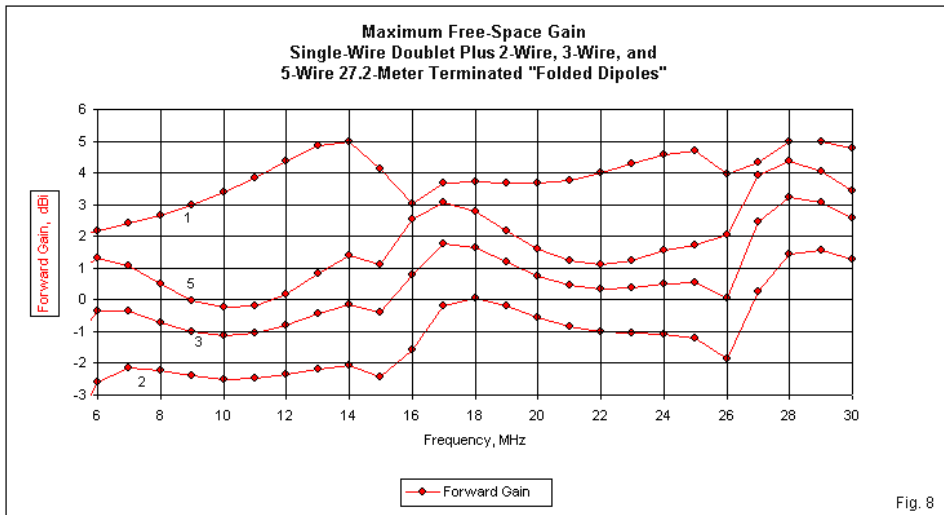

The expanded curves in **Fig. 8** show more clearly the parallel structure of the 2-wire, 3-wire, and 5-wire gain values across the recommended spectrum. As well, Y-axis expansion shows the high variability of the 5-wire gain curve. It sometimes almost reaches the level of the doublet, but on other frequencies, it falls closer to the level attained by the 3-wire antenna. Of course, the exact structure of these curves is subject to variation with small changes in construction--either overall length or spacing--or in the exact value of the terminating resistor. Nevertheless, the most notable trends remain intact.

Gain variations are NOT the result of any changes in antenna pattern as we move from one 27.2-m antenna to another. In fact,

the antenna patterns are functions of the overall wire length, and the presence of multiple wires and the terminating resistor does not affect any other property than lobe strength. (This statement requires a bit of modification: the wire length is the electrical length of the antenna rather than its simple physical length. Multiple wires tend to act like a single fat wire, making the antenna longer by a wider margin than a single wire. Hence, if all the subject antennas from 1 to 5 wires are the same physical length, the larger the number of wires, the electrically longer the antenna. The planar 5-wire may further complicate the calculation of electrical length due to the end connecting wires. **Fig. 9** overlays the patterns of all 4 antennas at 12 MHz. Perhaps the only difference detectable is at the junction of the main lobe with each of the minor lobes. The more wires the softer the curve at the junction. It is likely that the need for end wires to connect the horizontal wires is the main reason for the softened junction.

Free-Space E-Plane Patterns:  
Single-Wire Doublet  
and Multi-Wire  
Terminated  
Antennas

12 MHz

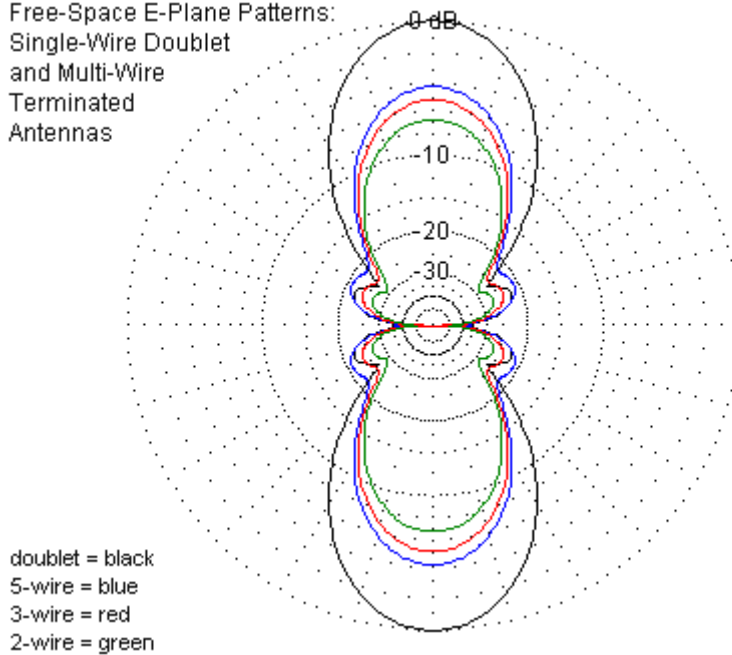

Fig. 9

The pattern test is repeatable on any frequency. **Fig. 10** provides a second sample of overlaid patterns at 24 MHz. Where lobes join (at pattern nulls), we once more find that if we have more wires and end wires in the antenna structure, the null points soften into curves. Other than that single phenomenon, the patterns are wholly congruent and vary only in lobe strength.

Free-Space E-Plane Patterns:  
Single-Wire Doublet  
and Multi-Wire  
Terminated  
Antennas

24 MHz

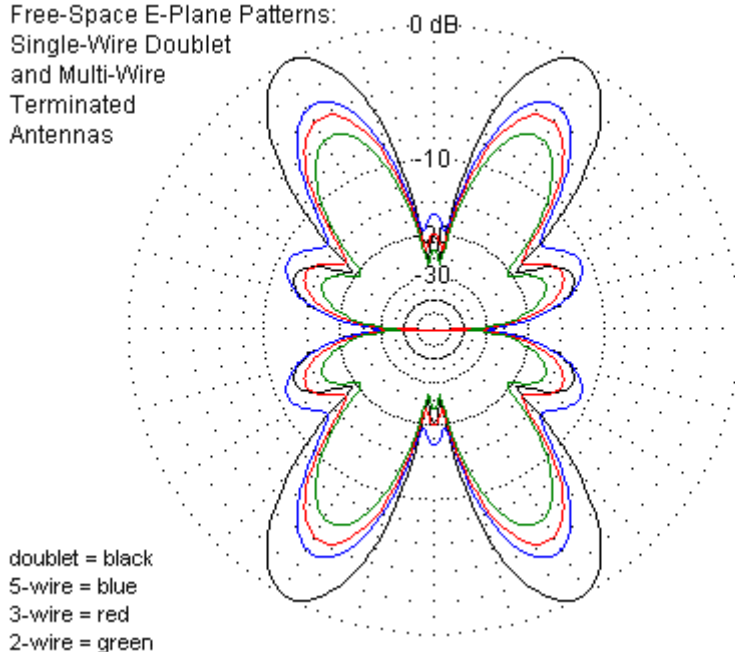
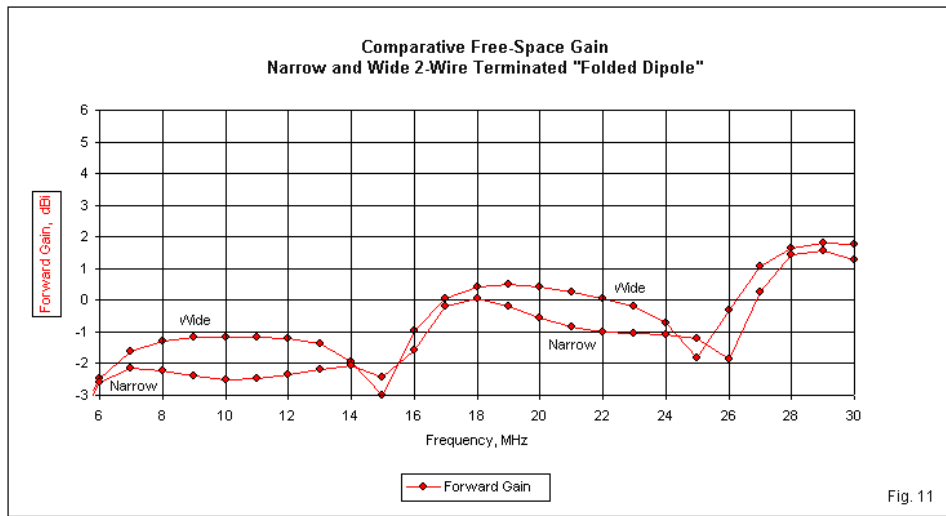

Fig. 10

Before we close this exploration, it may be wise to examine the effect of spacing between the wires in a terminated array. In a standard folded dipole, there is no significant difference in performance between narrow and wide spacing values, at least up to the point where the distance exceeds a value that will support 2-wire transmission-line operation. However, as we have noted, the terminated arrays only look like folded dipoles.

All of the terminated antennas used so far are 27.2 m long with a spacing between wires of 0.2 m (about 7.9"). I revised the spacing for a series of test models to a value of 1.5 m (59"). Because initial tests using diamond and fan configurations proved unpromising, I maintained the parallel runs of AWG #12 wires.



**Fig. 11** compares the maximum free-space gain values for the 2 versions of the 2-wire terminated array. The wider array shows an average gain increase of about 1 dB, although that increase does not appear at every frequency in the test range (using 6 MHz as a starting frequency). The original narrow version of the antenna used an 820-Ohm terminating resistor and a similar value for the SWR reference impedance. Widening the antenna required an



increase in both values to 900 Ohms. **Fig. 12** compares the SWR curves for both 2-wire antennas on the assumption that each will use an optimized impedance transformation device for any adjustment to match a coaxial cable. The SWR curves show no features that would dictate the use of one antenna version over the other.

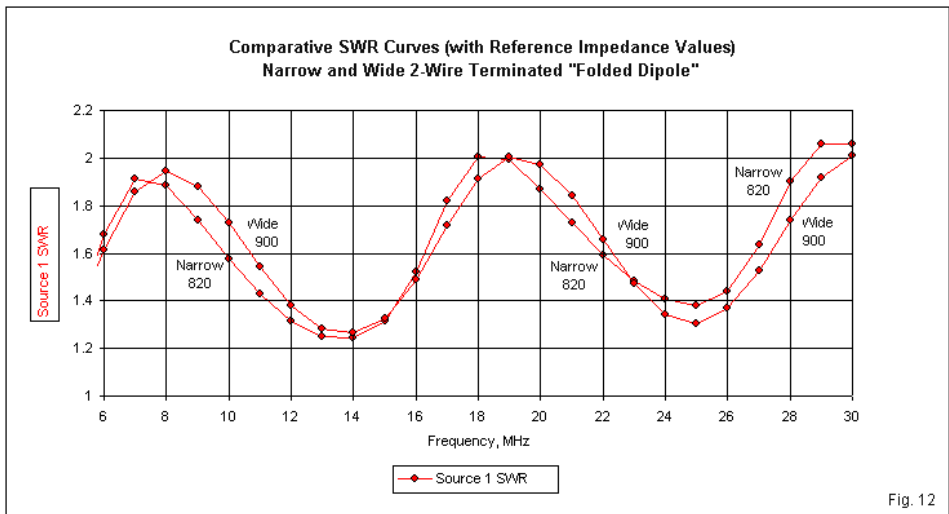

The 3-wire version of the terminated array used the same 1.5-m spacing in the wide version. The result is an array that is 3-m wide overall, with the terminated line between the fed wires. **Fig. 13** shows the comparative gain curves for the two antennas. The wide-version curve shows similar characteristics to the corresponding

curve for the 2-wire antenna. However, the gain differential between wide and narrow antennas averages close to 1.5 dB.

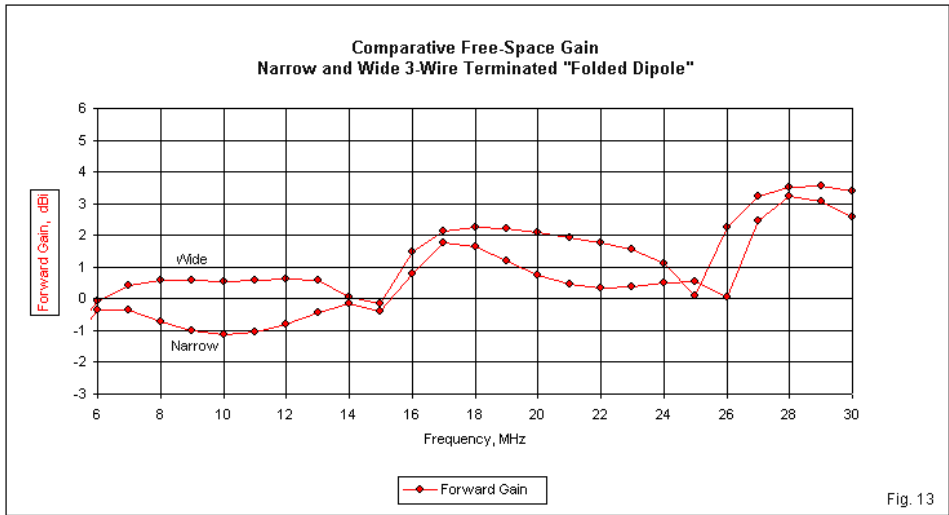

The terminating resistor for both the narrow and wide antennas is 900 Ohms. However, the best reference impedance for the wide version is about 450 Ohms, about 50 Ohms less than for the narrow version. **Fig. 14** traces both SWR curves. The curve for the wider version of the antenna shows larger excursions, but remains below 2:1 across the entire test range.

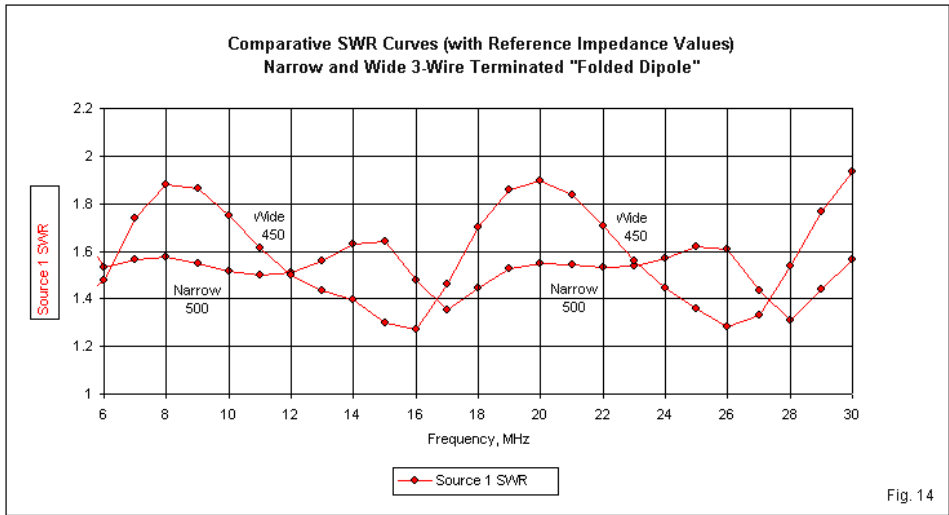

Although the 5-wire array remains the same length, its area grows by a factor of 7.5. The inner fed wires are 1.5 m from the terminated center wire, while the outer fed wires are 3.0 m from center. **Fig. 15** provides one measure of whether the increased width is worthwhile in terms of the overall gain advantage of the wider antenna. The wide array provides almost 2-dB average gain over the narrower (0.8-m) version. Unlike the 2-wire and 2-wire arrays, where the gain lines cross at certain frequencies, the wide 5-wire antenna shows a gain advantage throughout the operating spectrum.

(Remember that the gain measurements are for free space and are taken broadside to the plane of the wires. Part 2 in this exercise will

give us good reason to remember these limiting factors of this initial study.)

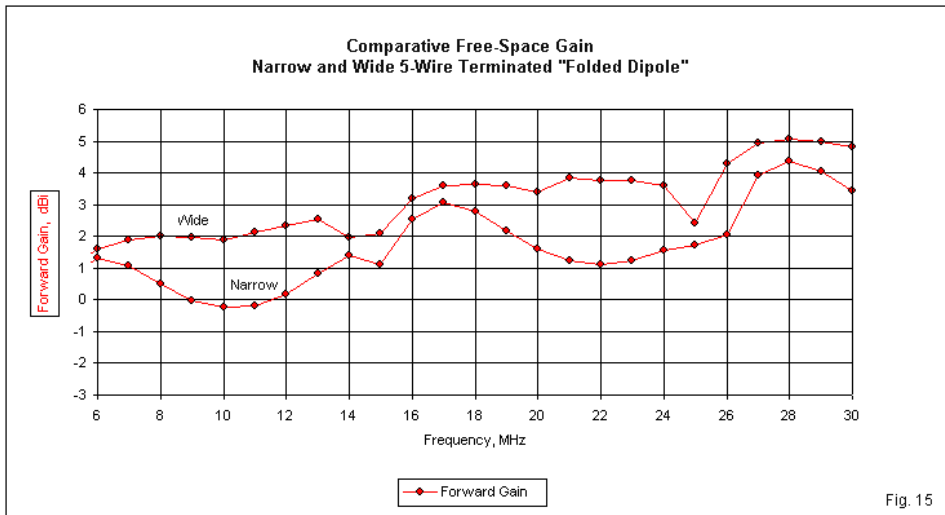

Both versions of the 5-wire antenna use 800-Ohm terminating resistors. As well, the reference impedance for both SWR curves is 300 Ohms. The average 300-Ohm SWR is lower for the wide antenna, although the specific value may vary at some selected frequencies. Unlike the narrow array, from 6 MHz upward, the wide array SWR makes only one excursion above the 2:1 level and remains below 2.2:1 at 13 and 14 MHz.

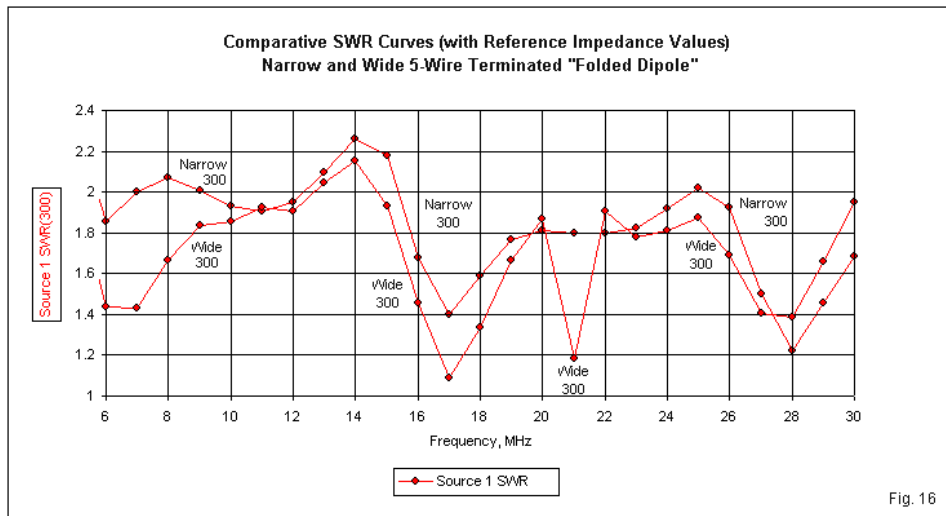

The following short table samples some of these results in tabular form. For a few frequencies between 6 and 12 MHz, the table lists the maximum free-space gain of each of the 6 terminated arrays. For comparison, the table adds a 7th gain column, listing the maximum gain of a single wire 27.2-m doublet.

Maximum Gain Comparison Among 27.2-m Antennas at Selected Frequencies.

Frequency	Maximum Free-Space Gain dBi						
	Doublet	2-Wire Narrow	2-Wire Wide	3-Wire Narrow	3-Wire Wide	5-Wire Narrow	5-Wire Wide
6	2.18	-2.59	-2.47	-0.36	-0.05	1.32	1.62
8	2.66	-2.22	-1.27	-0.70	0.58	0.50	1.99
10	3.38	-2.51	-1.15	-1.11	0.55	-0.25	1.91
12	4.37	-2.36	-1.20	-0.80	0.63	0.19	2.35

The table makes clear that the narrow 3-wire array is superior in gain to the wide 2-wire antenna and that the narrow 5-wire array is

superior in gain to the wide 3-wire antenna. However, each wide version is superior in gain to its corresponding narrow version. However, even the highest-gain terminated array (the wide 5-wire planar version) is deficient in gain by 0.5 to 2.0 dB relative to the single-wire unterminated doublet of the same length.

These results emerge from exploring only the plane that is broadside to the axis of the multi-wire antennas. We have not looked at the plane that would be edgewise to the wires. Nor have compared patterns taken broadside and edgewise to the plane of the wires. Moreover, we have not explored the relative gain of the various antennas at some common height above a specified ground quality.

### ***Some Tentative Conclusions***

This initial attempt to take a fresh look at multi-wire terminated wide-band antennas seems to justify a few general conclusions. These conclusions rest on 2 features of the investigation. One is the use of idealized models for 3- and 5-wire arrays that use virtual zero-spacing between the wires forming the parallel connections at the feedpoint. The second feature is the use of only partial data from the collection available to us from the models. Nevertheless, the project appears to show high promise for potentially improving the multi-wire wide-band terminated antennas that we might build.

1. All terminated wide-band folded dipoles have knee frequencies, below which the gain drops very rapidly. The recommended

operating range for any of the antennas is from an electrical length of about  $1/2$  wavelength upward in frequency.

2. As we add more fed wires to a terminated antenna, we increase its average gain over the operating spectrum. The gain increase never quite reaches the level of a single-wire doublet.

3. As we add more wires to a terminated wide-band antenna, the center or reference SWR impedance decreases both intrinsically and with respect to the value of the terminating resistor.

4. 2- and 3-wire terminated wide-band arrays show stable SWR curves through their operating ranges. However, adding further wires tends to produce curves with greater SWR excursions relative to the reference impedance.

5. Terminated wide-band antennas show increased gain by widening the distance between wires. Spacing adjustments may require revision of the optimal terminating resistor value and the reference SWR impedance.

Some of these conclusions are in fact generally true. Others may be only partially true or simply illusions based on the limiting factors of model formation and use in gathering data. Next, we shall explore the available data in greater detail and develop some all-wire models of the various arrays. That effort will allow us to sort out which of the conclusions are useful as they stand and which require modification, revision, or deletion.

For the moment, we may simply allow ourselves to be enthusiastic about the potential improvements that we have seemingly uncovered.



## Chapter 30: More on Wide-Band Multi-Wire Folded Dipoles

In Chapter 29, I developed idealized models of multi-wire terminated wide-band antennas as a pathway to understanding better their performance. I replicated 2-, 3-, and 5-wire terminated arrays using idealized techniques of feeding the antennas and examining the free-space patterns taken broadside to the plane of the wires. The patterns were all tidy, and the data seemed to show improved performance as a. we increased the number of wires and b. we increased the spacing between the wires.

In this follow-up episode, we shall try to rectify some of the shortcomings of the initial models. For the 3- and 5-wire antennas, we shall reform the models into all-wire versions for comparison with the idealized models. We shall also explore both the broadside and edge-wise patterns to see if we can find any differences of note. One of our goals is to improve upon the partial and sometimes faulty understanding offered by Chapter 29. Another goal is to stress the need for a full exploration of alternative ways of forming models and of the complete data set offered by modeling programs before declaring the work complete.

One major departure from the models in the previous Chapter rests upon some of the data that we acquired. Although terminated wide-band antennas offer a good match when we use them at frequencies below the knee frequency, rapidly increasing losses to the terminating resistor render such operations marginal to useless. Therefore, I increased the antenna length to 250', the length

needed to ensure that the antenna was electrically at least 1/2-wavelength at the lowest test frequency: 2 MHz. A simple doublet of this length shows considerable inductive reactance at a center feedpoint. Hence, we can be assured that the new models operate completely above the knee frequency. I also increased the wire size to AWG #10 on the premise that this size is a relatively wise selection for a 250' span of wire.

## 2-Wire Terminated Wide-Band Antennas

The traditional 2-wire terminated wide-band antenna is a good starting point for our work. It does not require special treatment for the feedpoint, since we may place the modeling source at the center of the unterminated wire. Hence, we shall have only 2 major concerns, both of which apply to the models in Chapter 29. First, we shall look at the effects of taking patterns edgewise to the wire plane instead of taking them broadside to the 2 wires. See **Fig. 1** for an outline sketch of the two orientations.

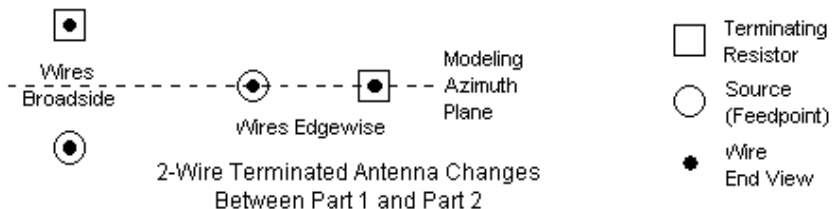

Fig. 1

Second, we shall review the effects of spacing the wires. We must increase the basic spacing in proportion to the scaling of the antenna that moved the knee from about 5.5 MHz down below 2 MHz. I shall employ a simple set of spacing values that will apply to all models in this part.

Spacing Standards for This Exercise Set	
Category	Spacing Between Parallel Wires (Feet)
Narrow	1
Medium	5
Wide	15

Most wide-band terminated antennas use a spacing between wires that is 1' or less. I chose 1' because it allows a reasonable narrow space for versions of the models scaled for higher frequencies and shorter lengths. At the other end of the line, 15' is a little under 5 meters, the scaled value that emerges from the wide versions of the antennas in Chapter 29. (Compare 250:15 and 27.2:1.5) Of course, I rounded the new numbers for bookkeeping simplicity.

For the new antennas, I also selected a single value for the terminating resistors in all versions: 900 Ohms. This value is especially useful, since one might create it from a parallel combination of 3 2700-Ohm non-inductive resistors. As noted in Chapter 29, there are other techniques for creating the terminating resistor.

Regardless of spacing, the 250' 2-wire antenna shows a very usable 900-Ohm SWR curves from 2 to 30 MHz. **Fig. 2** overlays the curves for the 3 spacing values. The SWR spikes occur at

intervals a little under 4 MHz, since the antenna passes integral full-wavelengths (electrically) at those points. The narrow version shows a few peaks just above 2:1 in the upper part of the overall passband. However, both wider versions manage to remain below the standard limit. In fact, the widest version shows a declining curve with increasing frequency.

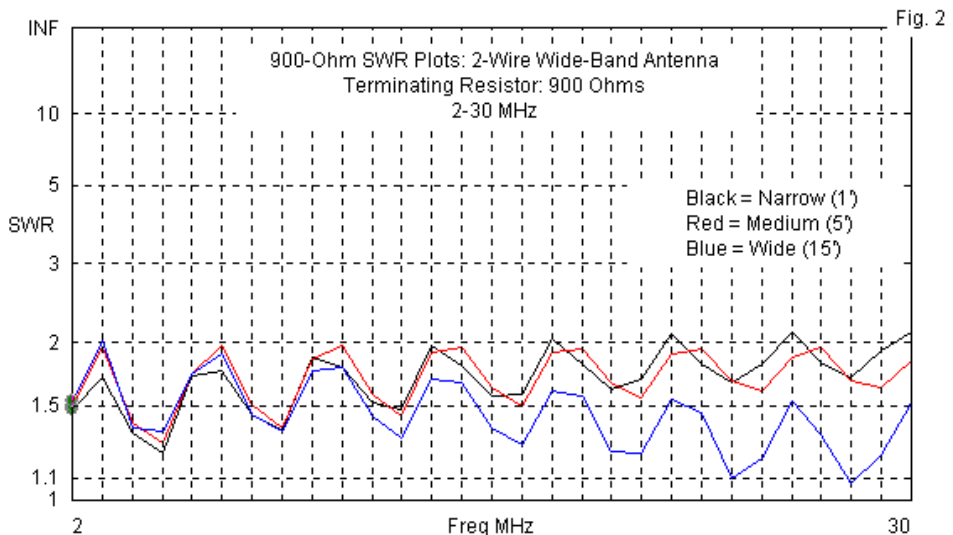

Note that the SWR reference impedance is the same as the value of the terminating resistor. This fact will become more interesting as we later look at the 3-wire and 5-wire antennas using the same 900-Ohm terminating resistor. For the moment, we may classify the SWR behavior of the 2-wire antenna--in any width--as quite well behaved.

The remaining question is whether the patterns are as well behaved as the SWR curve. In Chapter 29, we could not fairly evaluate this facet of performance because we took the patterns broadside to the plane of the two wires. In practice, at least the narrow versions of the antenna twist and turn in the wind and weather and hence may wash out any difference that we might find between edgewise and broadside behavior. However, the wider versions of the antenna would likely have a fixed non-twisting installation set-up. Most likely, that set-up would place all of the wires parallel to the ground. Hence, it will be useful to look at the edgewise performance.

The following brief table samples both the edgewise and broadside free-space gain values of the narrow, medium, and wide versions of the 250' 2-wire terminated antenna.

Free-Space Maximum Gain Values for 3 Versions of the 250' 2-Wire Wide-Band Antenna										
Frequency	2		3		4		5		15	
Maximum Gain (dBi)	E/W	B/S	E/W	B/S	E/W	B/S	E/W	B/S	E/W	B/S
Antenna										
Narrow (1')	-3.37	-3.45	-2.67	-2.74	-2.87	-2.88	-2.20	-2.32	1.61	1.47
F/B Ratio dB	0.16		0.13		0.01		0.23		0.29	
Medium (5')	-3.00	-3.30	-1.71	-1.94	-2.02	-2.08	-1.47	-1.96	2.12	1.98
F/B Ratio dB	0.61		0.49		0.16		1.08		0.48	
Wide (15')	-2.38	-3.03	-1.07	-1.47	-1.17	-1.53	-0.56	-1.97	3.28	2.20
F/B Ratio dB	1.45		1.01		1.07		3.65		4.50	
Reference Doublet		2.08		2.77		3.93		4.99		5.39

Note: E/W = Edgewise; B/S = Broadside; F/B = Front-to-Back

Despite its brevity and incompleteness, the chart generally confirms the trend noted in Chapter 29: as we increase the spacing between the conductors of a 2-wire terminated antenna, the gain generally rises. The rise does not occur for all frequencies at every widening, as shown by the move from 5' to 15' at 5 MHz, if we look at the

broadside gain value. Nevertheless, the general gain trend is upward with wider element spacing.

At the same time, sampling the edgewise gain values introduces a new dimension to 2-wire performance: a gain differential between the heading of maximum gain and a heading 180 degrees opposite. The chart calls this difference a front-to-back ratio. For narrow spacing, the differential is minuscule and operationally insignificant. Even at medium spacing (5' for a 250' antenna or 2%), only one of the listed values is potentially problematical. However, when the spacing reaches 15' (6%), the differential grows to troublesome proportions. At 15 MHz, the maximum gain in the favored direction is 3.28 dBi, but in the opposite direction the gain drops to -1.22 dBi. For modest front-to-back values, the front-to-back ratio is roughly twice the differential between the edgewise and the broadside gain. However, as we increase frequency and encounter higher differentials, the front-to-back ratio climbs at a faster rate. This phenomenon suggests that the pattern may undergo some serious distortion relative to the nearly perfect bi-directional patterns we expect from the narrow version of the antenna.

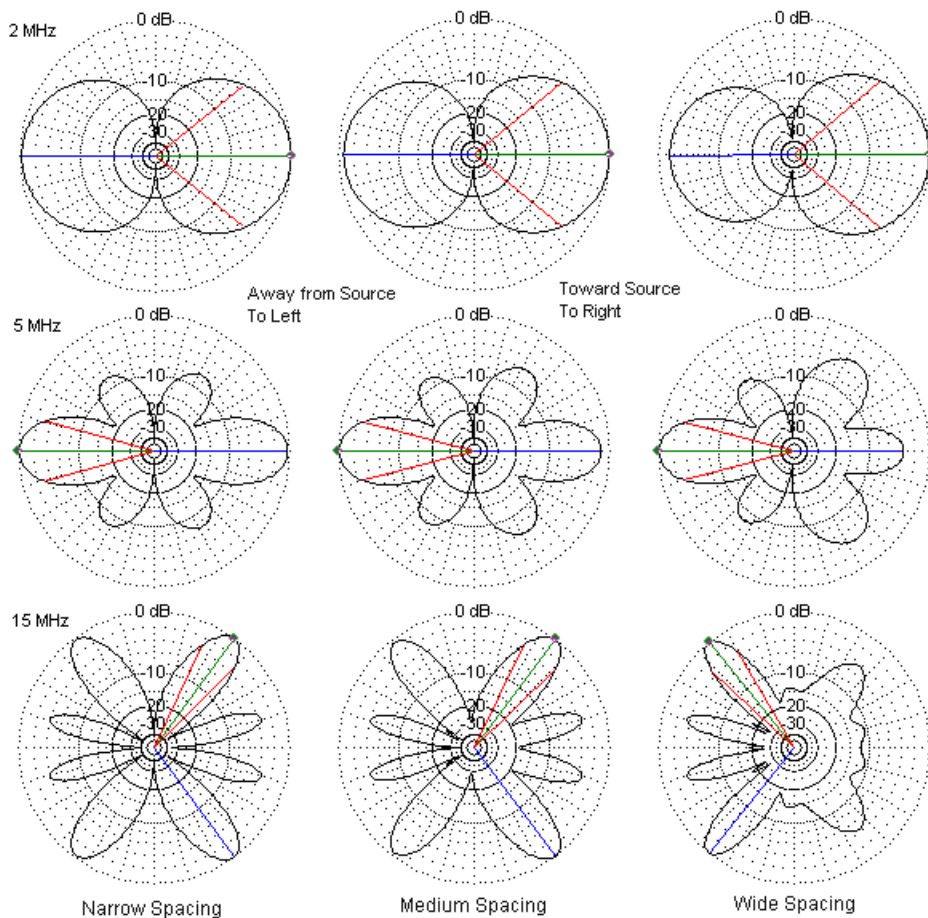

Sample 2-Wire Terminated Free-Space Antenna Patterns

Fig. 3

**Fig. 3** provides a small demonstration by providing edgewise patterns for all three spacing values at 2, 5, and 15 MHz. In all cases, view the antenna as running up and down the page or graph. The right side of the pattern is the direction toward the feedpoint and away from the terminating resistor. The left side of the pattern is the direction toward the resistor and away from the source. The 2-MHz patterns show a classical figure-8 pattern with a growing lobe toward the feedpoint side as we increase spacing. In contrast, the 5-MHz patterns show their growth toward the terminating-resistor side of the antenna. In addition, note that the widest spacing yields a difference in pattern shape. What we would call the main lobe on the higher-gain side becomes weaker on the opposite side, and the side lobes grow in strength to equal it.

The 15-MHz plots show major distortions of the pattern established by the narrow version of the antenna. If you closely examine the medium-version pattern, you can see a very slight displacement of the lobes toward the higher-gain side of the antenna. When we reach the limits of our spacing exercise, the pattern is very seriously distorted relative to the narrow-spacing version. Moreover, we find extra lobes. Of course, the overall loop circumference at the widest spacing is about 5.5% longer than at the narrowest spacing. As well, the 15' end wires are 0.2 wavelengths. At that spacing, the mutual coupling between wires does not form a single element, but acts somewhat like a distended loop antenna that is about 530' in total circumference--about 8 wavelengths overall.



The 2-wire terminated wide-band antenna is notorious for its low gain relative to a simple doublet. The table lists maximum gain values for the listed frequencies. The doublet's patterns are virtually identical in shape to those of the narrow version of the antenna, but the gain differentials for just the listed values range from about 4 dB to over 7 dB. Hence, the temptation to widen the spacing to obtain higher gain is strong. As shown in **Fig. 2**, the wider versions of the antenna sustain the SWR curves. However, before embarking upon the widening process, one must closely examine all patterns to determine if they will satisfy the needs of the application for the revised antenna. For general skip communications, the medium (5') version might fulfill the need, although the gain increment is marginal relative to the increased complexity of construction.

### 3-Wire Terminated Wide-Band Antennas

The 3-wire terminated wide-band antenna is especially interesting by virtue of its symmetry. Two outer wires, equally spaced from the center wire that contains the terminating resistor, are fed in parallel. The balanced layout results in a symmetrical edgewise pattern. From this perspective, the 3-wire array eliminates the front-to-back problem that appears in wider versions of the 2-wire antenna. However, effectively modeling the 3-wire version of the wide-band antenna presents challenges. **Fig. 4** outlines 2 ways to proceed with the modeling.

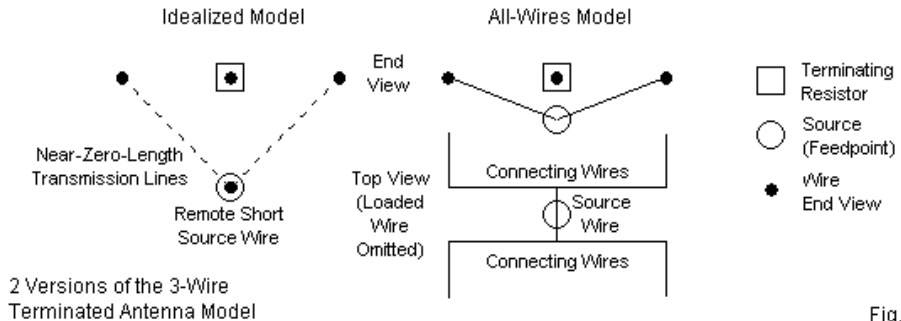
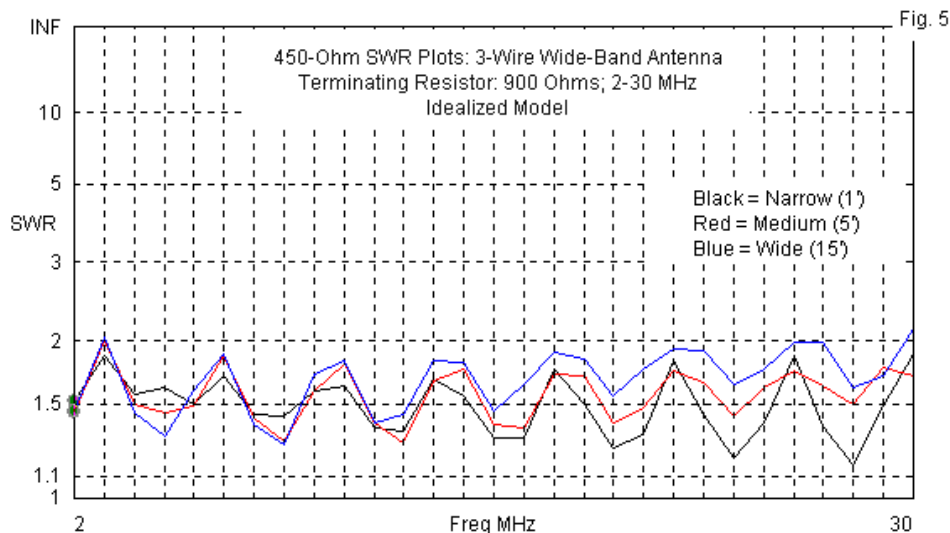

Fig. 4

The modeling scheme on the left uses the NEC transmission-line (TL) facility to create near-zero-length lossless leads to a remote source wire. I used this method of modeling in Chapter 29 as an initial assessment of the potentials for the antenna. For this exercise, I replicated the system with the 250' long 3-wire antenna, creating 3 variations. The narrow version uses a spacing of 1' between wires for an overall antenna width of 2'. The medium version uses 5' spacing for a total width of 10'. The wide version uses 15' spacing and results in a 30' maximum antenna width. Nevertheless, the leads from the wires to the combined parallel source remain very short electrically. **Fig. 5** overlays the SWR curves for the 3 versions of the 3-wire antenna.



The idealized model provides very well-behaved SWR curves for all 3 versions of the antenna. Note that the reference impedance is 450 Ohms, half the value used for the 2-wire antenna and half the value of the 900-Ohm terminating resistor. We obtained similar SWR curves in Chapter 29 with the shorter 27.2-m (89') 3-wire antenna.

Although useful as a preliminary modeling venture, the idealized model does not represent structural reality for any of the 3 versions of the 3-wire antenna. For parallel feeding of the antenna, we must use wires that reach from the outer element center to a common feedpoint. Therefore, I remodeled the antenna according to the right-hand sketch. The limitation of this modeling method is the

need for the center or source wire to equal in length a segment on the outer wire and for the segments on the connecting wires to be as equal in length as feasible to the other segment lengths. These requirements are not always well met, but the resulting models are adequate enough to detect general departures from the idealized model.

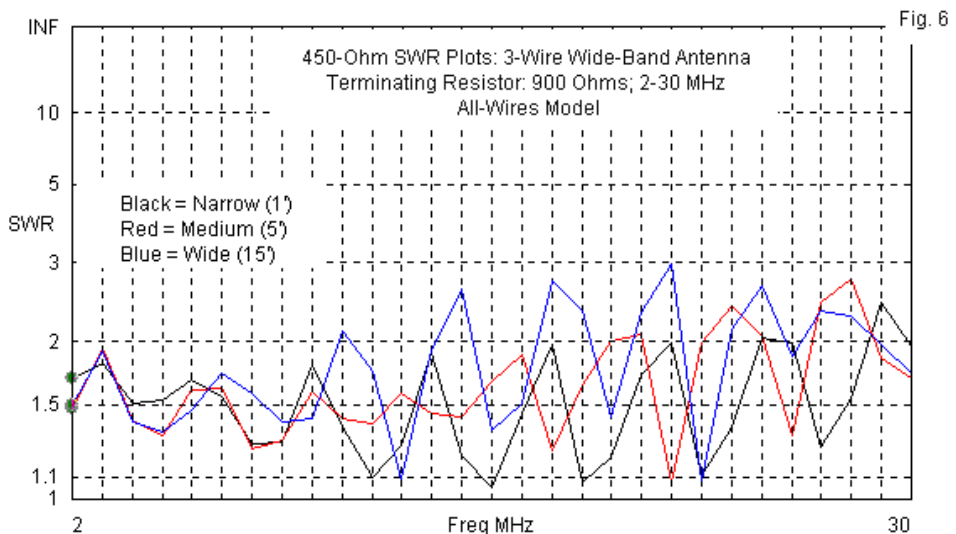

**Fig. 6** shows the overlaid 450-Ohm SWR curves for the revised model. The all-wire model suggests that the narrow version of the array is usable above 28 MHz before the SWR seriously exceeds 2:1. (We shall not consider impedance transformation losses and cable losses that might show a lower SWR at the operating position.) The medium version begins to show serious SWR

excursions from about 22 MHz upward. The widest version starts to exceed the 2:1 SWR standard at about 15 MHz. These curves are based on a feedpoint 1' below the terminating resistor and may vary in detail with different positions. As well, the exact structure of the feed segment and the connecting wires may further alter the curves. Nevertheless, we can see that the idealized model gives us too optimistic a portrait of the SWR behavior of the 3-wire wide-band array.

The picture is not necessarily bleak, however. Many applications for a antenna of this sort do not require full spectrum coverage. As well, numerous receiving applications may use relaxed SWR standards, perhaps up to 3:1 relative to the reference impedance. So the 3-wire antenna remains a viable alternative to the 2-wire wide-band antenna, while offering freedom from the front-to-back differential that besets wider versions of the 2-wire array. The question is whether the promise of higher gain will justify the more complex 3-wire array. As a sampling, I have set up a table similar to the one used for the 2-wire array.

Free-Space Maximum Gain Values for 3 Versions of the 250' 3-Wire Wide-Band Antenna

Frequency	2		3		4		5		15		30	
Maximum Gain (dBi)	E/W	B/S	E/W	B/S	E/W	B/S	E/W	B/S	E/W	B/S	E/W	B/S
Antenna												
Narrow (1')	-0.26	-0.26	-0.96	-0.96	-1.35	-1.34	0.00	0.01	2.85	2.92	6.46	6.53
Medium (5')	-0.92	-0.91	-0.65	-0.65	-0.81	-0.76	-0.07	0.03	2.66	2.98	4.93	5.50
Wide (15')	-0.80	-0.67	-0.24	0.02	-0.23	0.24	-0.68	0.15	1.49	4.14	2.69	6.76
Reference Doublet		2.08		2.77		3.93		4.99		5.39		8.11

Note: E/W = Edgewise; B/S = Broadside

In virtually every sampled case, the 3-wire gain exceeds the 2-wire gain, and often by a significant margin. The rough average of the gain differential between the 3-wire narrow antenna and the doublet is about 3 dB, just over half the deficit shown by the 2-wire array.

From a raw gain perspective, the 3-wire array is attractive for applications committed to a wide-band terminated antenna.

However, the 3-wire array is not immune to pattern distortion. One form is evident from the tabulated data. As we widen the spacing between wires and increase frequency, the broadside gain shows ever-larger values relative to the edgewise gain. The differential likely makes no great difference up through medium spacing. However, the wide-space version shows well over a 1-dB differential from the frequency mid-range upward. Note that the differential shows itself most vividly in the frequency region in which the wide-space version shows the largest SWR excursions. As well, the tabulated data does not show a clear gain advantage over medium and narrow spacing.

A second form of pattern distortion appears in the wide version of the array within the upper frequency edgewise patterns themselves. **Fig. 7** shows the 15-MHz patterns for both the broadside and edgewise planes of the wide version of the antenna. For the edgewise pattern, visualize the antenna as extending vertically within the plot. For the broadside pattern, orient the antenna horizontally with respect to the graph. On the right side of the figure are the patterns for the narrow version of the antenna. These plots follow the form of a single-wire doublet, but at lesser strength. The broadside pattern for the wide version of the antenna almost replicates the pattern for the narrow 3-wire antenna. However, the edgewise pattern for the wide version is significantly different. As well, the tabulated data shows this pattern to be not only weaker

than the broadside pattern, but also weaker than the edgewise pattern for the medium and narrow versions of the array.

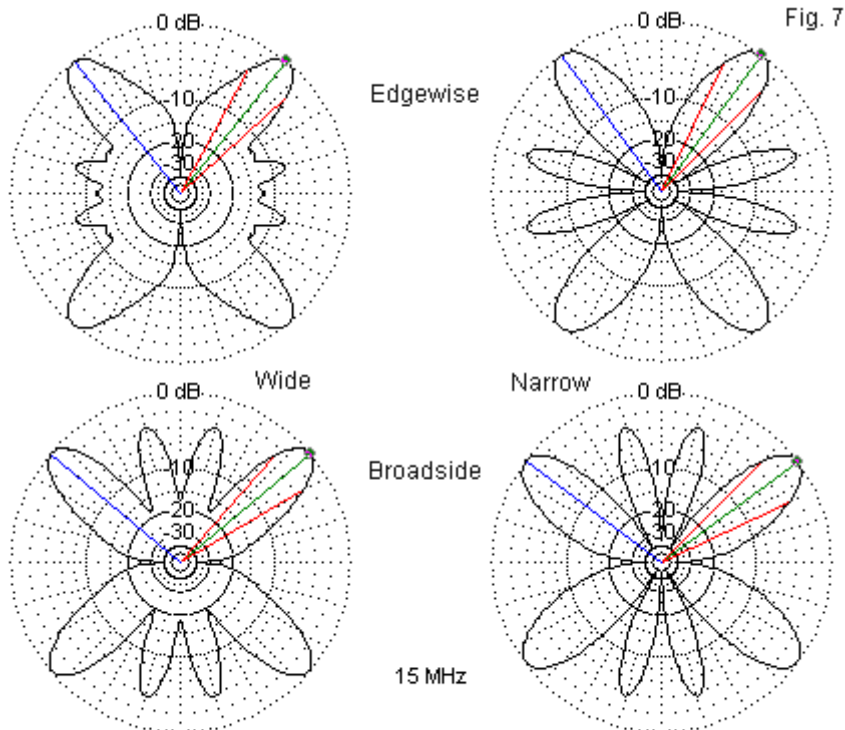

Free-Space Patterns: 3-Wire Wide-Band Narrow and Wide Antennas  
Broadside and Edgewise to the Plane of the Wires

To establish that the 15-MHz pattern is not an isolated instance of more severe pattern distortion, **Fig. 8** shows the patterns for 30 MHz, using the same format. Once more, the patterns for the narrow antenna show little, if any, difference between broadside and edgewise views. However, the wide antenna shows changes to both patterns. The broadside patterns show a widening and shrinking of the peak values of the minor lobes. The edgewise pattern shows the opposite development, although some careful observation is necessary to see it. In the narrow edgewise pattern, careful scrutiny will show some very tiny minor lobes between the larger minor lobes--almost invisible without either a table of radiation pattern values or a gross enlargement of the pattern. In the edgewise pattern for the wide antenna, those lobes have grown to equal size with the other minor lobes to form a large and complex set of lobes.



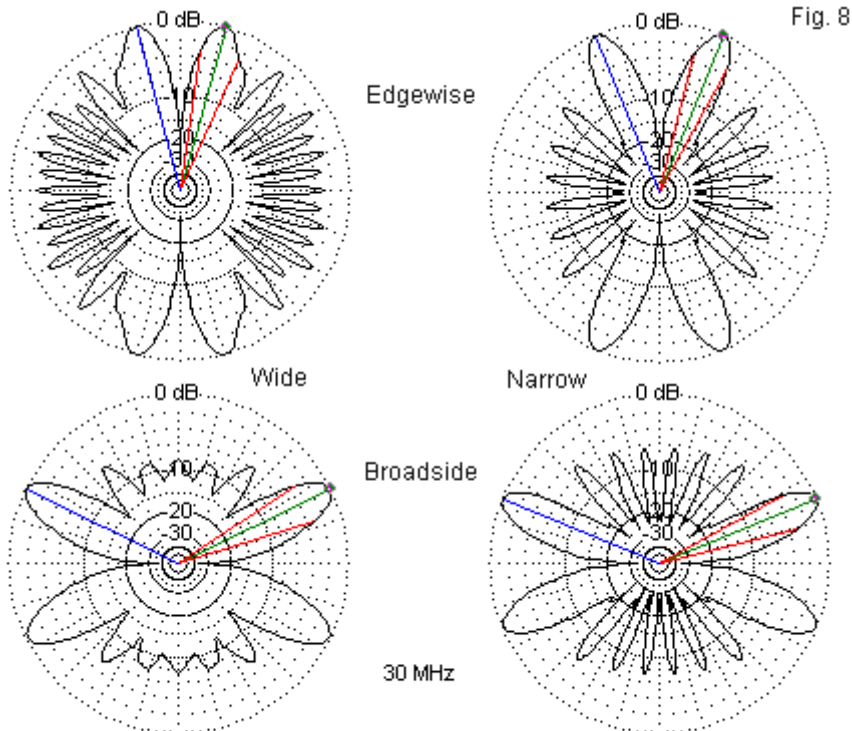

Free-Space Patterns: 3-Wire Wide-Band Narrow and Wide Antennas  
Broadside and Edgewise to the Plane of the Wires

Unlike the 2-wire wide-band terminated antenna, which showed a significant improvement of gain as we widened the space between wires, the 3-wire array does not show the same gain development when we model it using an all-wire configuration. Rather, we find the relative gain values of the 3 widths simply to vary across the

spectrum. In some cases, the narrow version yields the highest gain; in others, it does not. When we add to this gain variability the fact that only the narrow version promises a stable SWR curve across the entire operating spectrum, we begin to approach a conclusion. Add in the absence of significant pattern distortion and a relative simplicity of construction and the conclusion becomes more solid. In a 3-wire wide-band array, the narrow version has perhaps the most potential of the 3 widths for actual use.

The narrow 3-wire array holds the promise of higher gain by a significant margin over the 2-wire array, although the actual gain margin will change from one frequency to the next. However, even the 3-wire array falls significantly short of the gain offered by a single wire doublet that uses no termination. In amateur radio service, where the use of parallel transmission line and a wide-range antenna tuner in the shack may serve very well to handle frequency changes, the single-wire doublet is still the antenna of choice. For short-wave reception--especially in Europe, where overloading signals are common--the 2-wire terminated system may be the antenna of choice, since the overall signal reduction may prevent or at least ease receiver overload and resultant spurious products. Only where a system needs both to transmit as well as receive and to be able to change frequencies without any equipment retuning does the 3-wire system come into its own--so long as there is excess receiving gain to compensate for the loss of sensitivity and there is excess power available to make up for the losses within the terminating resistor.

## 5-Wire Terminated Wide-Band Antennas

The 5-wire terminated wide-band antenna showed great promise of better approaching the level of gain performance achieved by the simple single-wire doublet while providing a possibly usable SWR curve. Of course, like all of the antennas in our survey, the initial models checked only the broadside free-space patterns and used the idealized model for initial checks. The leftmost part of **Fig. 9** shows the end view of that modeling scheme.

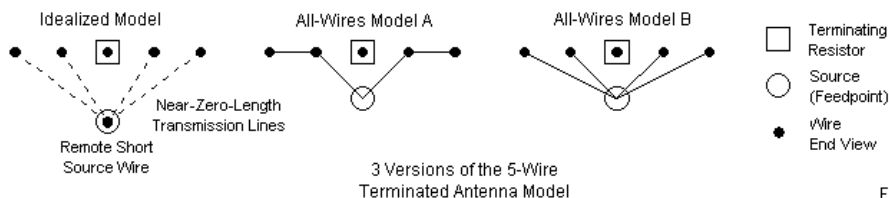
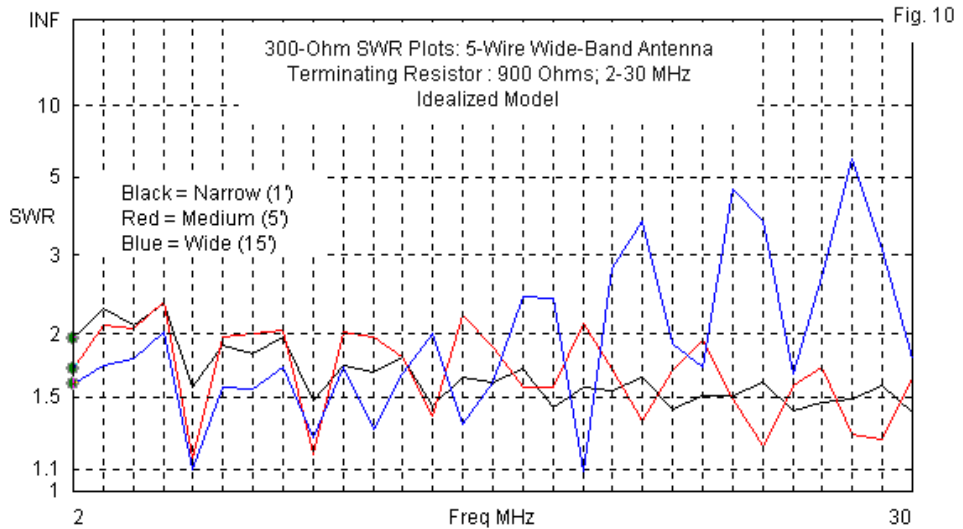

Fig. 9

Converted to the scale used in this exercise, the antenna is now 250' long and has a total width of 4' for the narrow version, 20' for the medium type, and 60' for the widest version, using parallel wire spacing of 1', 5', and 15', respectively. In addition, we shall orient the antenna so that the edgewise view is parallel to the ground, although we shall take interest in the differential between the edgewise and broadside patterns in free space.

The antenna uses a 900-Ohm terminating resistor, the same value as used in all of the other wide-band antennas in this exercise. The required SWR reference impedance turns out to be 300 Ohms for all variations on the 5-wire antenna. We may note in passing that

the decrease in the required SWR reference impedance undergoes a regular progression in its descent as we add wires to the array.



**Fig. 10** reviews the 2-30-MHz SWR curves for the narrow, medium, and wide versions of the 5-wire array. Even under the idealized feed conditions with near-zero-length leads for the parallel-connected wires, the SWR curve is somewhat limited. The narrow antenna provides the best curve, although the SWR is somewhat high at the low end of the operating spectrum. As we increase spacing, the curve improves at the lowest frequencies, but the wide version appears to be usable only up to the middle of the spectrum (about 16 MHz).

We may proceed in two general ways to create all-wire models with more realistic feed systems. The center sketch in **Fig. 9** shows a 2-lead version (A). Wires extend from the inner fed element to the central feedpoint 1' below the terminating resistor. The outer elements simply connect to the inner elements to complete the overall feed system. In effect, the outer elements acquire extra length compared to the inner wires, with another increment of length added at the far end of the wires. **Fig. 11** shows the resulting SWR curves for the 3 antenna widths.

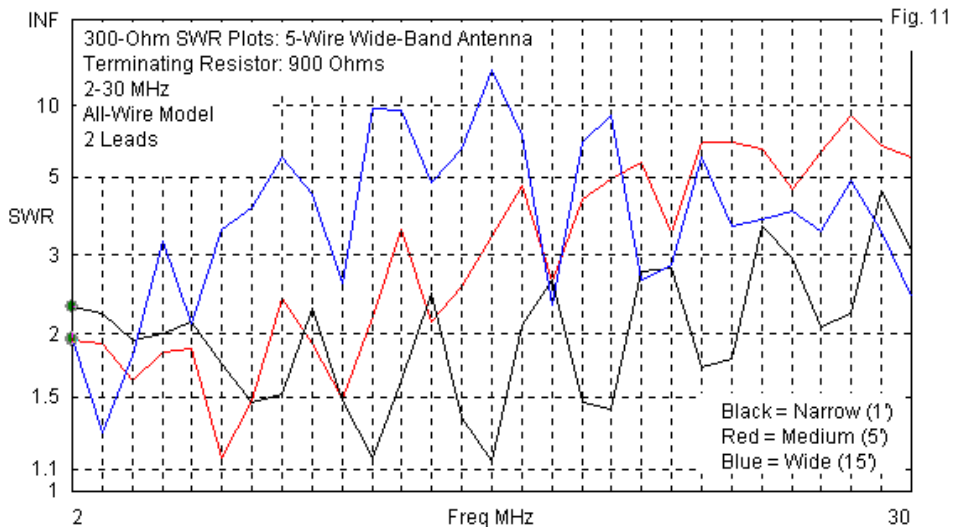

Note that the SWR curves begin to gyrate widely and somewhat wildly for the widest version. In common, the curves show increasingly high peak SWR values as we raise the operating

frequency. The narrow version of the array is the only one usable for most of the operating spectrum, but only if we relax the 2:1 SWR limit standard.

As an alternative, I modeled the arrays with separate leads from each fed wire to the common feedpoint. The right-most sketch in **Fig. 9** shows the general outline of the 4-lead model (B). The question was whether this feed system would alter the SWR curves relative to the 2-lead model. **Fig. 12** shows the results of the trials.

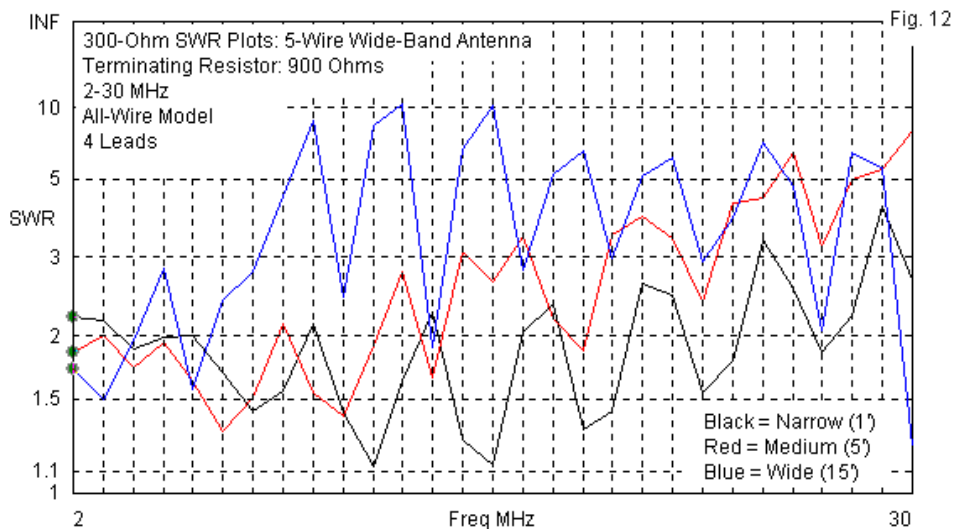

Clearly, we do not gain anything by using the alternative feed method. Although the details differ in terms of the exact frequencies and values for SWR peaks, only the narrow version of the 5-wire

antenna shows potential for extended frequency use. The medium-width version of the antenna is again usable up to about the middle of the spectrum, and the wide version shows a rapid decay of good SWR performance above about 7 MHz. Varying the reference impedance does not alter the performance significantly. The key problem in all versions of the 5-wire array is the presence of very significant reactance levels at most frequencies.

Despite the initial optimism offered by the idealized model in terms of developing a 5-wire wide-band antenna, remodeling the array more realistically with wire leads to the center feedpoint presents serious obstacles to further development. Only the narrow version of the antenna has a bandwidth potential resembling the curves that we obtained for the 2-wire and 3-wire antennas--and then only if we relax the SWR standard. However, one feature that gave the basic idea of a 5-wire array its allure was the potential for significantly higher gain than either of the smaller antennas. Despite the SWR problems, we should explore this facet of the antenna. The following table of sample values parallels the one for the 3-wire antenna to provide for direct comparisons. As we did when checking maximum gain for the 3-wire antenna, we shall provide gain values for both the edgewise and broadside planes relative to the antenna. In addition, we shall examine values for both the 2-lead and the 4-lead versions of the array.

Free-Space Maximum Gain Values for 3 Versions of the 250' 5-Wire Wide-Band Antenna													
Frequency	2		3		4		5		15		30		
Maximum Gain (dBi)	E/W	B/S	E/W	B/S	E/W	B/S	E/W	B/S	E/W	B/S	E/W	B/S	
<b>2-Lead Antenna</b>													
Narrow (1')	1.59	1.59	0.28	0.28	-0.16	-0.14	1.72	1.74	3.74	3.83	7.14	7.29	
Medium (5')	0.93	0.97	0.73	0.82	0.73	0.90	1.56	1.85	3.33	4.19	5.46	6.56	
Wide (15')	0.84	1.19	0.92	1.71	1.07	2.60	-0.42	2.50	0.79	6.92	4.93	-0.22	
<b>4-Lead Antenna</b>													
Narrow (1')	1.44	1.44	0.36	0.37	0.03	0.04	1.74	1.76	3.81	3.91	7.02	7.16	
Medium (5')	0.81	0.85	0.53	0.62	0.56	0.73	1.46	1.75	2.54	3.36	4.17	0.78	
Wide (15')	0.76	1.11	0.71	1.50	0.94	2.47	-0.42	2.55	1.54	8.82	5.11	-0.71	
Reference Doublet		2.08		2.77		3.93		4.99		5.39		8.11	

Note: E/W = Edgewise; B/S = Broadside

As expected, the wider the array and the higher the operating frequency, the greater differential that we find between edgewise and broadside maximum free-space gain values. In general, there is no significant difference between the gain behavior of the 2-lead and 4-lead versions of the 5-wire antenna. Both narrow versions show a good coincidence between the edgewise and broadside gain values. However, as we widen the antenna, the upper spectrum values actually show a decline relative to the narrow version of the antenna. As well, the differentials grow to considerable proportions, with one value set showing a 7-dB differential. Initially, then, the first order conclusion might be that only the narrow version of the array holds potential for wide frequency use. Interestingly, this conclusion from free-space gain data coincides with the conclusion suggested by the SWR data.

The sampled gain values reveal another interesting pattern to antenna performance. Let's overlay a few patterns for the single-wire reference doublet and the 5-wire narrow antenna, using the 2-lead version. However, let's examine both the free-space values and the values 75' above average ground (conductivity 0.005 S/M, permittivity 13). Additionally, we shall restrict the frequency range to extend from 2 to 6 MHz. This last measure operates on the premise



that not all applications of wide-band antennas require coverage of the entire HF spectrum. Instead, some operational needs require no-tune operation of some part of the spectrum. **Fig. 13** provides the SWR curves for the 5-wire array using the 300-Ohm standard and for the single-wire doublet using a 75-Ohm standard.

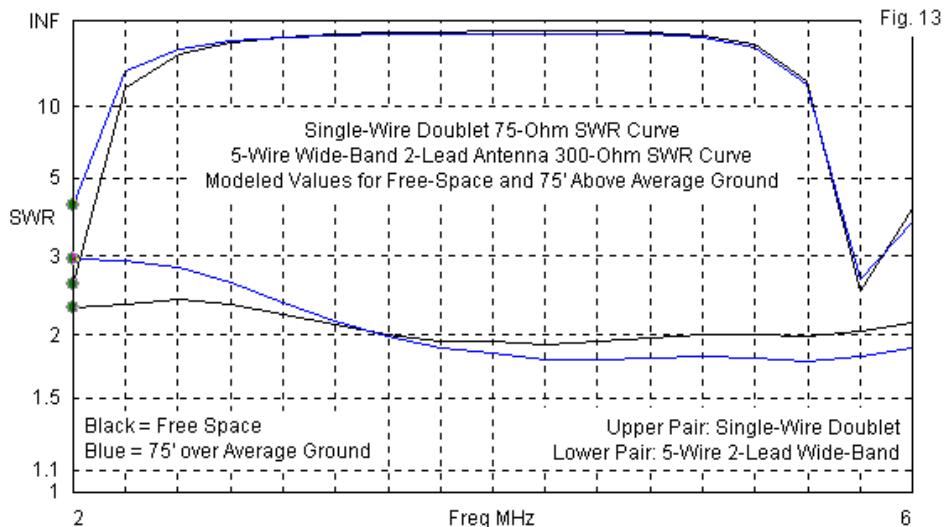

The antenna height (75') is only a small fraction of a wavelength at the lower end of the spectrum. Hence, we find deterioration of the SWR curve for both antennas relative to the free-space model. The doublet curves clearly show that the antenna is longer than 1/2 wavelength at the lowest operating frequency. As well, the doublet curves show the need for extensive impedance matching efforts as we change frequency. Although the 5-wire SWR curves are not

perfect, they present far less of a matching challenge to 300 Ohms (and from that value down to a coaxial cable value via a wide-band impedance transformer).

Now let's compare the maximum gain values, letting ground-reflection phenomena settle any remnant differential between edgewise and broadside gain values that we encountered in free space. The following table tracks doublet and 5-wire narrow values every half-MHz for our reduced operating spectrum.

Maximum Gain values for a Single-Wire Doublet and a 5-Wire 2-Lead Narrow Array 75' above Average Ground

Single Wire Doublet									
Frequency	2	2.5	3	3.5	4	4.5	5	5.5	6
Maximum Gain (dBi)	6.84	7.07	7.09	7.30	7.87	8.73	9.42	8.09	7.64
Elevation Angle	90	90	71	55	48	41	36	33	28
5-Wire 2-Lead Wide-Band Antenna									
Frequency	2	2.5	3	3.5	4	4.5	5	5.5	6
Maximum Gain (dBi)	6.22	5.77	4.53	3.95	4.19	5.20	6.51	6.11	7.53
Elevation Angle	90	90	72	56	47	41	36	33	29

The table shows that at the low and high ends of the restricted operating range, the gain values for the 5-wire array virtually match those of the single-wire doublet. At the center of the range, from 3.5 to 4.5 MHz, we find the greatest difference in values, with a 3.5-dB deficit. **Fig. 14** provides a few sample patterns for both antennas, overlaid to show the degree of coincidence or difference.

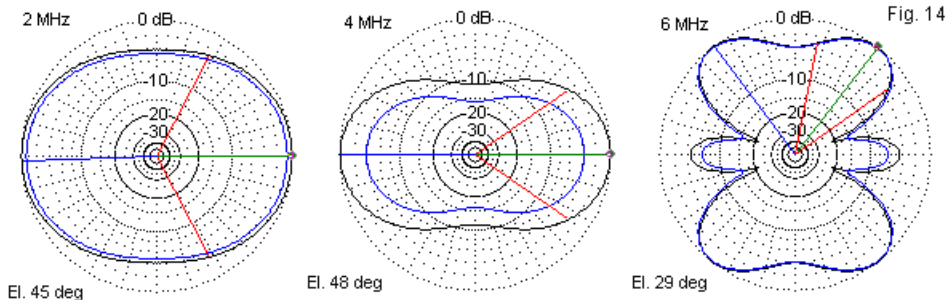

Selected Azimuth Patterns: Single Wire Doublet and 5-Wire 2-Lead  
Wide-Band Antenna 75' Above Average Ground

Once the antenna passes the 1.25-wavelength mark in electrical length, it of course results in a pattern where the main lobes are no longer broadside to the wire, as shown by the 6-MHz pattern. However, we may also view a more fundamental correlation by jointly examining **Fig. 13** and **Fig. 14** (or the table). The doublet 75-Ohm SWR values--and hence, the general level of the feedpoint impedance--are lowest at or near those frequencies for which the 5-wire array shows a gain level that most closely matches the doublet's gain. When the parallel combination of fed wires in the wide-band antenna would present a very low impedance, the terminating resistor absorbs (and dissipates) the least energy, resulting in the highest gain. When the resistor value is low relative to the feedpoint impedance without it, the resistor handles a proportionately higher percentage of the power, leaving less for radiation. This theory of operation applies to all multi-wire wide-band antennas using a terminating resistor. The 5-wire version of the antenna simply makes the process more graphically apparent.

With a restricted operating range, the antenna models make apparent the danger of simply taking an average value of gain deficit of a wide-band antenna relative to a doublet. The more pressing question facing a design engineer is whether the worst-case deficit falls above or below the level of acceptability relative to the intended application.

Since we have explored the difference between the SWR curves for the 5-wire, 2-lead antenna over a limited range, we might also explore whether the differences apply to other parts of the overall operating spectrum. **Fig. 15** shows the comparative plots for the narrow 2-wire wide-band antenna. The antenna is 75' above average ground for all comparisons. As the plots show, the SWR curves diverge until about 9 MHz. At that frequency, the antenna is about 0.7 wavelength above ground. Below that frequency, we find small differences in the curves that likely would not create any operational problems.

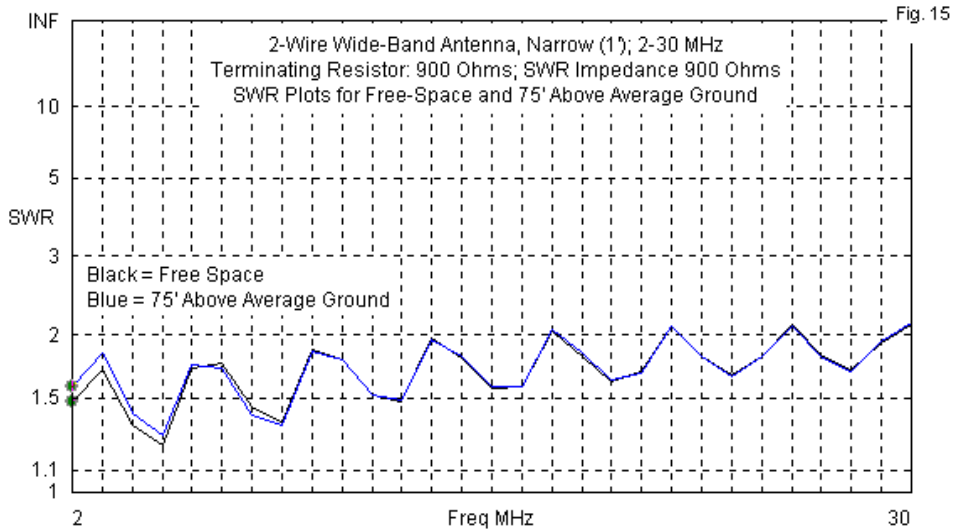

In **Fig. 16**, the graph compares SWR curves for free-space and over-ground versions of the narrow 3-wire wide-band antenna. The curves overlay each other very well down to just below 10 MHz. Again, the 0.7-wavelength (or perhaps the 0.75-wavelength) height marks the beginning of SWR curve divergence. Note that in this case, the modeled over-ground value for the all-wire antenna just exceeds 2:1 at 2 MHz. The actual test measurement for the antenna under these conditions would depend upon impedance transformation and line losses, as well as construction variables relative to the model.

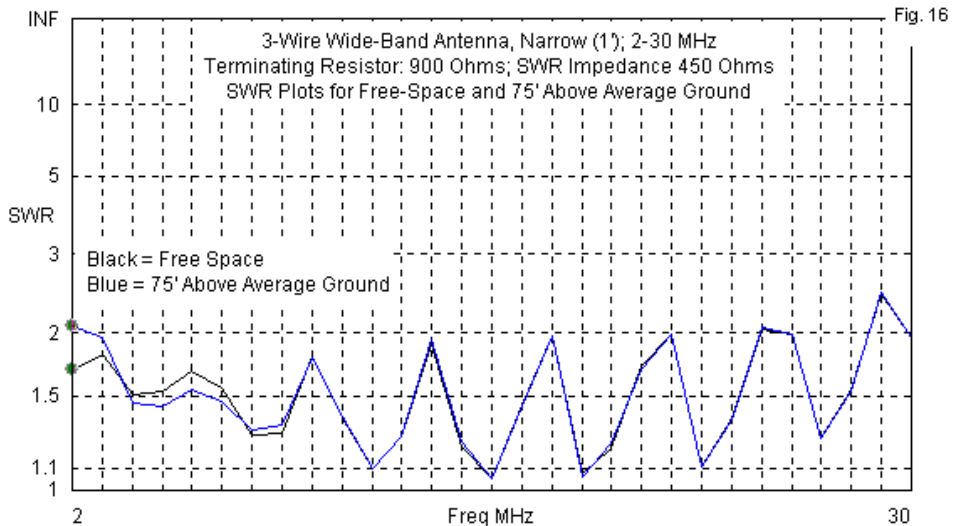

**Fig. 17** expands the narrow 5-wire, 2-lead SWR curves shown in **Fig. 13** to encompass the entire potential operating spectrum. Once more, the free-space and over-ground curves track each other very well from about 9.5- to 10-MHz and upward. Below the transition frequency area, the curves diverge, with the over-ground curve showing a higher SWR value at the lowest frequency in the spectrum covered. Lengthening the antenna might well move the SWR from 2 to 6 MHz below 2:1, but at the same time, it would reduce the frequency span over which we can obtain bi-directional patterns. The relative importance of each factor is an application-specific determination.

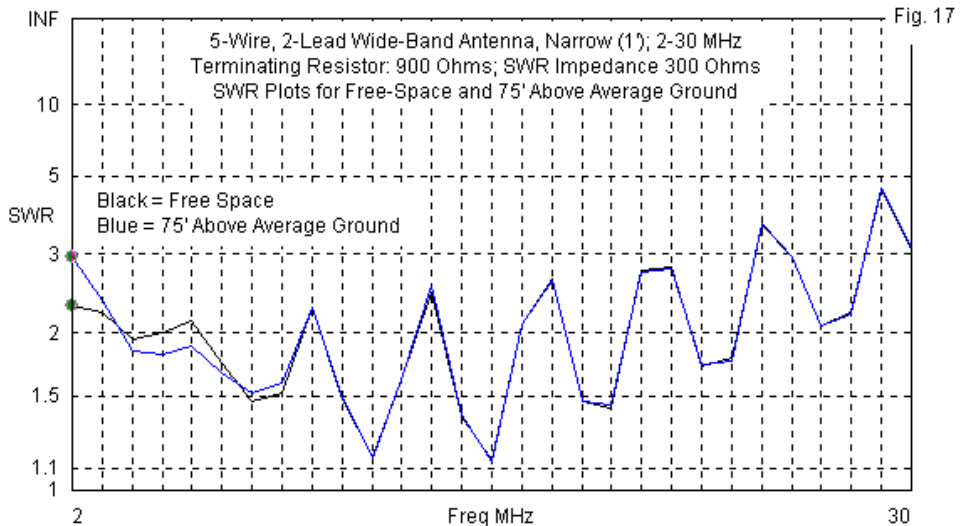

## Construction Variables

The sensitivity of the multi-wire terminated antenna arrays to changes in width relative to various performance characteristics suggests that these notes inevitably fall far short of covering all possible design variations. However, length and width are not the only variables available for alteration. One significant variable may escape attention. The all-wire models place the common feedpoint 1' below the terminating resistor and its element wire. We may vary that placement and see what might happen. To test the matter, I created a very narrow version of the 3-wire (all-wire) antenna using a spacing of 0.5' between wires. Then I set the feedpoint 1, 2, and 3 feet below the antenna, using a free-space model. The key

question in this exercise focused on the effects of the 3 placements on the SWR curve. **Fig. 18** shows the results.

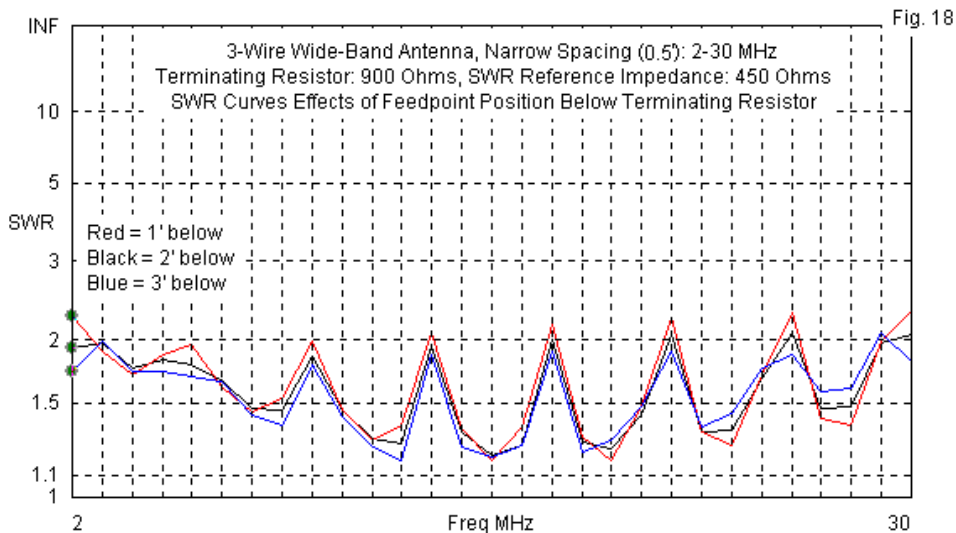

The very narrow version of the 3-wire array shows the most acceptable SWR curve with the common feedpoint 3' below the terminating resistor wire, the limit of this particular exercise. The 450-Ohm SWR does not exceed 2:1 until the operating frequency reaches 29 MHz, and then not by much. To see whether the phenomenon is unique to the very narrow spacing or more general, I repeated the test using the standard narrow 3-wire spacing (1'). The results appear in **Fig. 19**.



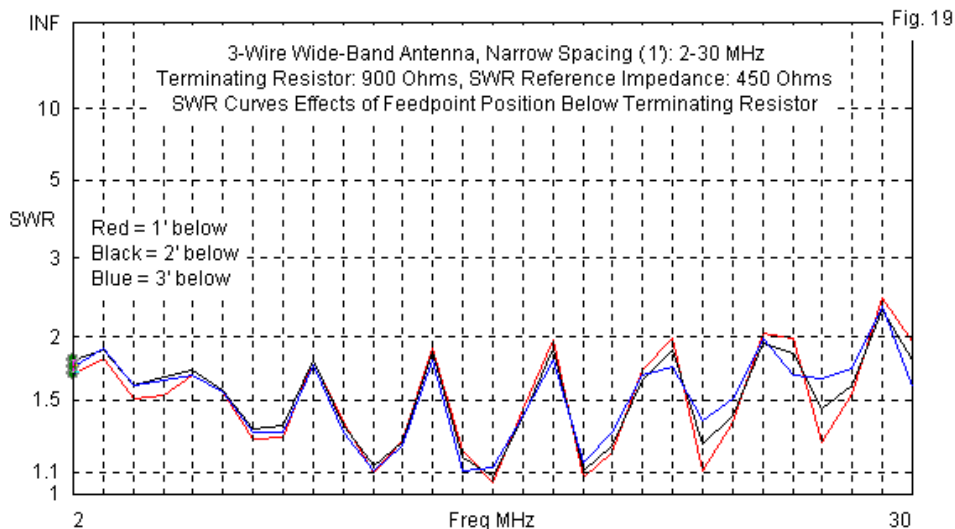

The results for the standard narrow spaced 3-wire array are less dramatic. The closest feedpoint spacing shows the widest excursions of SWR--both high and low--for most of the operating range. The widest feedpoint spacing appears to improve SWR performance in the upper range, but not to the degree possible with very narrow spacing.

Wide-band terminating-resistor arrays are subject to many construction variables, and these simple exercises provide only a sample. However, they do show that we cannot assume that any particular variable is either significant or insignificant until we examine it in detail.

## Conclusion

At the end of Chapter 29, based on a limited exploration of terminated antenna properties, I reached a set of conclusions. We may now assess how well each holds up and what qualifiers we may have to place on some of them.

1. All terminated wide-band "folded dipoles" have knee frequencies, below which the gain drops very rapidly. The recommended operating range for any of the antennas is from an electrical length of about  $1/2$  wavelength upward in frequency.

The first conclusion remains correct, although we by-passed testing it in this exercise by using an antenna that was longer than the critical minimum length at the lowest test frequency.

2. As we add more fed wires to a terminated antenna, we increase its average gain over the operating spectrum. The gain increase never quite reaches the level of a single-wire doublet.

We must heavily qualify this statement. Although the average gain of the 3-wire array exceeds the average gain of the 2-wire version, and the 5-wire average gain is higher still, average gain may not be the key factor in making design decisions. The gain will be highest wherever the equivalent doublet length shows the lowest impedance. However, we must keep a sharp eye out for the lowest gain levels within a proposed operating span to determine if the gain at critical frequencies is high enough for the proposed communications application. We may examine that gain as an

intrinsic value or as a deficit relative to the single-wire doublet, depending on the frame of reference.

3. As we add more wires to a terminated wide-band antenna, the center or reference SWR impedance decreases both intrinsically and with respect to the value of the terminating resistor.

Our extended exercises actually provided a bit more precision to this statement by standardizing the terminating resistor at 900 Ohms and watching the required SWR reference impedance. The criteria for setting the SWR reference impedance are not precise, since the setting requires a judgment call as to what counts as the smoothest obtainable SWR curve over a given operating region. Nevertheless, the 2-wire array showed its best curves when the SWR reference impedance matched the value of the terminating resistor. The 3-wire array gave the best results when the SWR reference impedance was 1/2 the value of the terminating resistor. With the 5-wire arrays, the best reference impedance was 1/3 the value of the terminating resistor.

4. 2- and 3-wire terminated wide-band arrays show stable SWR curves through their operating ranges. However, adding further wires tends to produce curves with greater SWR excursions relative to the reference impedance.

Once we modified the 3-wire and 5-wire antennas to provide all-wire model construction, the stability of even the 3-wire curves began to slip badly as we widened the array. The SWR performance for the 3-wire array showed wide SWR swings in the

wide version. The 5-wire all-wire model strongly suggested that it was useful only over restricted frequency ranges, and then only in the narrow version.

5. Terminated wide-band antennas show increased gain by widening the distance between wires. Spacing adjustments may require revision of the optimal terminating resistor value and the reference SWR impedance.

The final conclusion in the series requires the greatest modification. The initial models registered gain as a function of free-space patterns broadside to the plane of the wires. Hence, they could not show the growing differential of edgewise and broadside gain as we increased the spacing between wires. Our exploration of the 5-wire models in this extended exercise shows that the net gain of a wide model may not always exceed that of a narrow model. Moreover, the existence of any differential at all makes a strong recommendation for modeling a proposed design over ground at the anticipated height of actual use. At the low end of the operating range, we may fairly gauge the effects of the mounting height and soil type on the SWR performance. As we move up the spectrum, the gain differentials increase, and modeling over ground allows us to arrive at a single gain value, whether we handle it independently or in comparison to the single-wire doublet that the wide-band antenna ostensibly replaces.

To the list of conclusion derived from Chapter 29 and modified here, we may add a new one.

6. Due to the many construction variations possible with a multi-wire wide-band terminated antenna, range testing at the anticipated use height and over the anticipated ground quality is an essential ingredient in the development of a successful antenna.

## Chapter 31: About the Folded Monopole

Literature about multi-wire monopoles is fraught with odd labels for the structures. We can find terms like *folded monopole*, *folded isopole*, *caged monopole*, and *skirted monopole*. If we can find legible diagrams for what the labels label, we are in for something of a surprise: they all refer to the same class of antenna. However, some engineers prefer to reserve the title of *folded monopole* for an antenna with only 2 wires. Others apply the term more generally to all or most multi-wire monopole systems. To the best of my knowledge, the *skirted monopole* terminology arose when the outer wires served as a means for detuning the monopole--usually a tower--from its sensitivity to interact with nearby (near-field) AM BC transmitting antennas. Hence, detuning skirts are common on urban cell towers. However, we can also feed the skirt on a transmitting tower and obtain a measure of impedance transformation and control that turns out to be useful. We might speculate that the expression *caged monopole* arose as a somewhat more politically correct than the term *skirted monopole*. Regardless of the humor we may make out of the terminological morass, we are left with a basic question.

*Is the multi-wire skirted or caged monopole a folded monopole or isn't it?*

Let's start at some sort of beginning by looking at some forms of multi-wire monopoles. **Fig. 1** shows a few of the many possible configurations. On the far left is a standard 2-wire folded monopole. It forms a touchstone for all that follows. At this stage, I shall note

only one interesting property of the standard folded monopole. Edgewise to the wires, we find a very tiny (and operationally insignificant) asymmetry to the antenna's gain. For ordinary wire spacing, the differential might be up to 0.04 dB in models, favoring the feedpoint side of the antenna. The broadside gain is the average of the edgewise gain values. Next to the 2-wire folded monopole is a 2-wire folded monopole with an extension on the return-wire side. (In practice, it makes no difference whether the extension connects to the fed wire or to the return wire if the connecting wire is short enough as a function of a wavelength.) I drew the antenna in the manner shown because it shows the relationship of a folded monopole with an extension to a gamma or omega matched tower used by some amateurs on 40 meters. If we assume that the antenna would be self-resonant without the extension, then with the extension, we find an increase of both the resistive and the inductive components of the feedpoint impedance. If the fed wire length does not result in a self-resonant antenna without the extension, then we usually call the added fed wire a *matching line*. The preferred term here is a function of what we are trying to achieve more than it is a difference in the electrical performance of the antenna. Like all folded elements, we shall find both a transmission line function and a radiating function within the folded section.

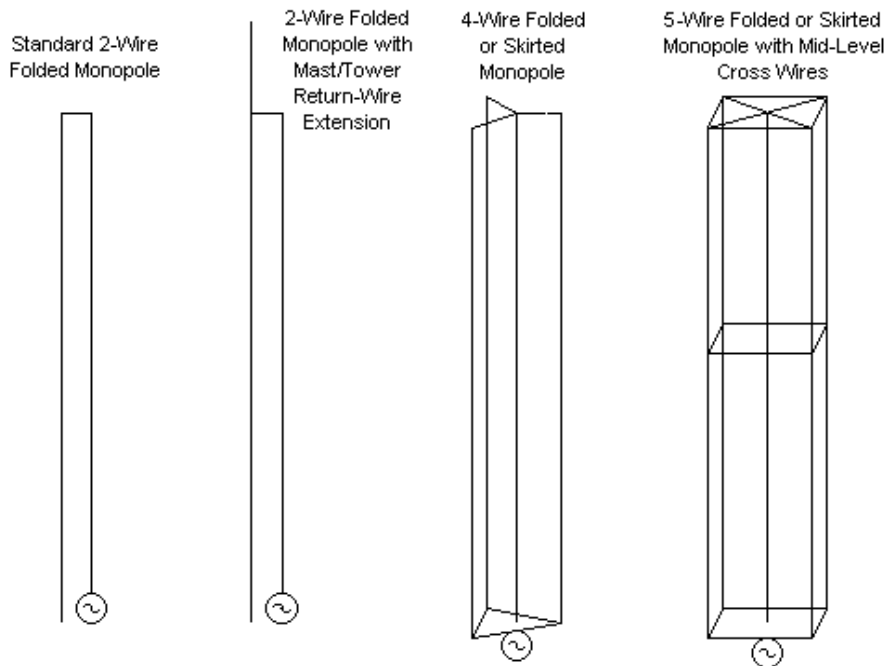

Fig. 1

Some Types of Folded or Skirted Monopoles

The sketches jump to 4- and 5-wire structures. However, a 3-wire monopole system is both possible and interesting. If we place wires on opposite sides of a return wire/tower and if we feed both new wires in parallel, we obtain a rudimentary caged or skirted system. Like the more complex 4- and 5-wire systems in **Fig. 1**, it produces a symmetrically circular azimuth pattern. In fact, within very narrow limits--largely a function of the fact that the more complex cage



systems tend to result in slightly shorter antennas when they are self-resonant--the gain of all types of caged, folded, or skirted monopoles is the same. (Some models of these antennas have shown more deviant values, but they usually correct to the basic value when adjusted for the average gain test (AGT) score of the model.) Over perfect ground using lossless wire, the entire set of self-resonant monopoles show a median gain of 5.15 dBi, with less than about +/-0.04 dB variation.

The two sketches on the right of **Fig. 1** differ in only one small way. The 5-wire monopole uses one or more wires that circle or girdle the outer wires only. In large installations, the connecting wires serve an important mechanical goal to help rigidify the cage of very long out wires. Also note that the sketches show a set of connecting wires at the base with a single feedpoint between the wire and ground. (We shall presume that all return wires in the figure return to ground.) In theory and in practice, the single feedpoint can result in slightly different current magnitudes and phase angles along the outer wires. The connecting wires create short circuits along the structure that tend to equalize currents along the outer wires.

We may replace the energy source with a network and change the system function from radiation to tower detuning. There are numerous techniques that allow engineers to use essentially the same caging wires to detune a tower from most frequencies within the upper MF range. Some techniques may involve modifications to the cage of wires as well as to the base network. Tower detuning via skirts has become a fairly routine and commonplace

engineering service. Its necessity and profitability has increased with the proliferation of cell-phone and other UHF/microwave towers that now pervade urban, suburban, and rural landscapes.

For our purposes, we may bypass the detuning role of skirts and cages in order to address more directly our initial question: are they forms of folded monopoles? To approach an answer, let's begin by seeing what makes the 2-wire folded monopole so special.

## **The Folded Dipole and the Folded Monopole**

Hardly a soul among those interested in antennas does not know about the folded dipole. Unfortunately, what many folks know is only a tiny piece of the story. If we parallel two identical wires at a reasonably close and constant spacing, if we connect the ends and feed one of the wires, and if we bring the antenna to resonance, then the feedpoint impedance on the selected fed wire is 4 times the impedance of a linear resonant dipole. There is much more to the folded dipole story than this, and I have tried to tell some of it in Chapter 27.

Part of the story involves the fact that a folded dipole and a linear dipole have the same gain and pattern. Another part of the story involves the fact that a folded dipole is two devices in one. It is a dipole and has radiating currents that almost exactly parallel the radiating currents of a linear dipole in both magnitude and phase angle. The folded dipole is also a transmission line (or, counting from the feedpoint, two transmission lines with a common starting point) with a relatively constant current magnitude and phase angle

(that is 90 degrees out of phase with the radiating current). John Kuecken showed how to separate the two currents in *Antennas and Transmission Lines* (pp. 224 ff).

Perhaps the most significant part of Kuecken's account is that he describes the technique in connection with the *hairpin monopole* (another name for the folded-monopole list of aliases). The technique applies equally both to folded monopoles and to folded dipoles, since the former is simply half the latter if terminated in a perfect ground or in a ground plane the approximates a perfect ground. If we make the folded structure self-resonant using a perfect ground and lossless wire, a dipole will show about 72 Ohms for a feedpoint or source impedance (resistive, of course), while a linear monopole will show 36 Ohms. Folded versions of the two will show 288 and 144 Ohms, respectively under suitable conditions.

**Fig. 2** shows the correlation of the two antennas and their linear roots.

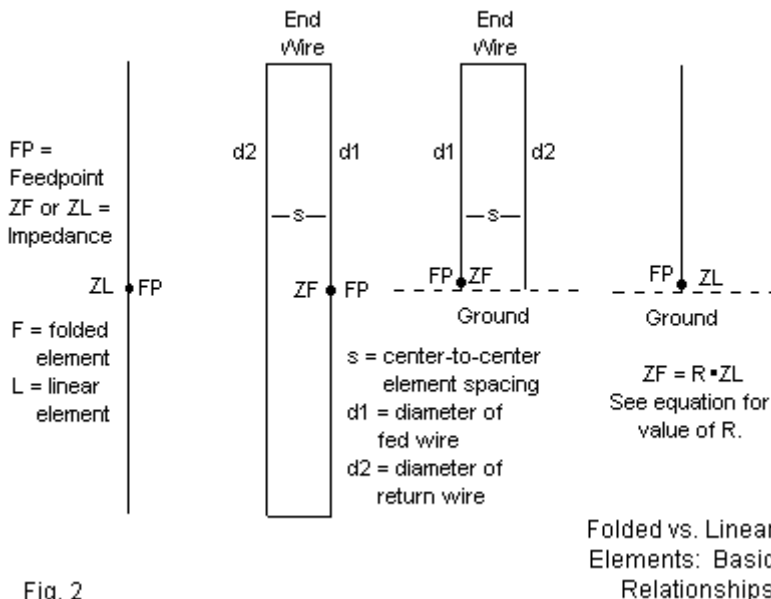

Fig. 2

The "suitable conditions" clause of the folded antenna impedance report presumes that the two wires in the folded structure have the same diameter. As well it presumes that the two wires are close enough to form a transmission line rather than simply an open loop or open half-loop. Unfortunately, too many amateurs are unaware that we may effect other impedance transformations by varying the diameters of the two conductors, or the spacing between them, or both. **Fig. 2** hints at that wider range of potentials by designating the wire spacing as  $s$ , the diameter of the fed wire as  $d1$ , and the diameter of the return wire as  $d2$ . How these dimensions (all in the

same unit of measure) go together to effect an impedance transformation appears in the following equation.

$$R = \left( 1 + \frac{\log \frac{2s}{d_1}}{\log \frac{2s}{d_2}} \right)^2$$

If  $d_1$  and  $d_2$  are equal, then the right side of the expression in ( ) is 1, and to that number we add 1, to get 2, which squares to 4 as the value of  $R$ , the ratio. Hence, the most common case of a folded dipole multiplies the linear dipole impedance by 4. A folded monopole meeting the same conditions does likewise. Next, let's make the return wire diameter go to an infinitesimal value. We cannot let it go to zero or we cannot have a return wire, but an infinitesimal diameter will suffice to leave us with a wire, but one that reduces the  $d_2$ -diameter and right side of the expression in ( ) to a value insignificantly different from zero. Within the ( ) we now have a value of simply 1, which squares to 1. This condition sets the minimum transformation in a folded dipole or monopole. In other words, a folded mono-/di-pole cannot transform an impedance downward from the linear value--only upward. On the other hand, making the return wire very small drives the denominator on the right side of the expression in ( ) toward zero, increasing the value of the fraction to an indefinitely high value. For most antenna work, resulting ratios ( $R$ ) greater than 10:1 are seldom encountered. However, we often find conversion ratios

above 4:1, especially in gamma-match structures, where the gamma rod is considerably thinner than the main element to which it attaches.

**Fig. 2** also labels the end wires that must be part of any real folded antenna. I note these wires because they do have an effect on the physical version of what we calculate from the equation. The wires must be short enough that their effect is relatively insignificant. However, their effect is real and shows up in computer models of folded dipoles and monopoles. One easy way to see the effect is to create a resonant model of a folded dipole using wires having different diameters. Now alternately use the fat wire or the thin wire diameter for the end wires and recheck the required length for resonance. You may also wish to look at the current tables available in NEC and MININEC for additional confirmation of the effect of end wires. To make the effect more vivid, use a lower frequency with a fairly wide physical spacing (such as 3' at 3.5 MHz) and use enough total segments so that the end wires have multiple segments.

If we create a multi-wire cage around the center wire, we can achieve two different orders of phenomena. We place the source on the center wire, and then the set of cage wires (any number from 2 upward for a total folded antenna count of 3 upward) increases the impedance transformation ratio. We rarely encounter this situation. However, users of cages around a central mast or tower in the upper MF and lower HF regions often feed the cage wires in parallel, allowing the fat center wire to serve as the return wire. This practice serves a number of ends. First, it allows the

central tower a direct connection to ground. Not only does this move simplify the tower's mechanical structure, it also is an important safety measure. Second, using the central mast or tower as the return wire results in an impedance transformation ratio that is lower than 4:1. By choosing the correct number of wires for the cage or skirt and feeding them in parallel, we can obtain an impedance that is higher than a monopole's 36-Ohm value over perfect ground but much lower than the 4:1 value of 144 Ohms. Indeed, a 4-wire cage provides a value that is very close to 50 Ohms, virtually ideal for coaxial cable.

## The Root of the Issue

The problem that we encounter with both physical antennas and their NEC models is that the resultant impedance does not coincide with the basic folded dipole/monopole equation. The resultant impedances that we encounter when connecting parallel sources together for a caged or skirted monopole do not answer to any simple relationship to the 2-wire folded monopole (or dipole). As a consequence, some engineers hesitate to identify the caged or skirted monopole with the 2-wire monopole.

We might initially treat caged monopoles in a variety of ways. For example, we might consider the structure to be a version of a coaxial monopole in which the return wire forms a center conductor, with the outer wires forming the outer conductor corresponding to the braid on an ordinary coaxial cable. However attractive this picture may be, we also must recognize that the outer wires leave mostly empty space. In addition, if we apply the 2-wire equation to

this situation, then the value of  $d_1$ , the fed wire, becomes identical to the value of  $2s$ , that is, twice the spacing between conductors. The common log of 1 is zero, resulting in an impedance transformation of 1. Hence, a resonant monopole under this treatment would show a 36-Ohm impedance. However, cage monopoles show a higher impedance, with the actual value being partially a function of the number of wires.

Alternatively, we may model various samples of cage monopoles and, with due attention to AGT scores, arrive at reasonable estimates of the resulting impedance. We quickly discover a factor that the coaxial treatment cannot take into account directly. For any given return wire ( $d_2$ ) diameter, as we change the diameter of the outer wires, the resultant antenna impedance will change. The coaxial treatment can use only one value for  $d_1$ , taken just now to mean the overall outside diameter of the cage system. It is possible to obtain from the basic equation an impedance that is equal to the modeled (or field tested) value by using a selected value of diameter for  $d_1$ . However, this treatment is initially ad hoc. It involves varying the diameter of  $d_1$  until the impedance value matches the modeled or field value. If we survey enough values, then we might use some form of regression analysis to arrive at correlations that would be usable for almost any (practical) combination of center diameters, spacing values, and cage-wire thicknesses. Nevertheless, regression analysis is an excellent tool for establishing a mathematical correlation to a set of curves derived from observation, but it does not provide an explanation of the correlation. The equations would not necessarily fit any set of



known electrical foundation equations to provide a seamless continuum between 2-wire and multi-wire folded dipoles.

The absence of a means of direct derivability that might ensure that cage monopoles are a variety of folded monopole--or that might provide sufficient reason to withhold the connection--does not mean that we must give up on the problem. There may be other alternatives yet to be explored. Any such alternative must recognize that the presence of multiple fed wires that do not surround the center conductor or return wire will present disturbances to a strict correlation. Indeed, perhaps part of the past thinking that wishes to claim that a cage monopole is not a folded monopole has looked too strictly at what a cage does not do and too little at what it does do. Granted, a cage lacks the solidity to form a true coaxial surface. However, let us suppose that each fed wire forms with the central return wire a 2-wire folded dipole. Under this supposition, we can expect the fed wires to interact or mutually couple. The degree of interaction would vary with the diameter of the center return wire, the spacing, the diameter of each out fed wire, and, of course, the relative diameters of the fed and return wires. Despite the variables, we should still be able to detect a pattern of values that we can trace to the results of a 2-wire folded monopole.

## A Test and Its Limitations

Within certain limits, we may set up a fairly simple modeling test. For the test we shall use a series of monopoles, as shown in **Fig. 3**. Each monopole will be resonant at a given test frequency. Since we shall use lossless wire and perfect ground to minimize the number

of extraneous variables, virtually any frequency will do. My test frequency will be 3.5 MHz. When modeling each test structure, the monopole will be resonated to within  $\pm j0.1$  Ohm.

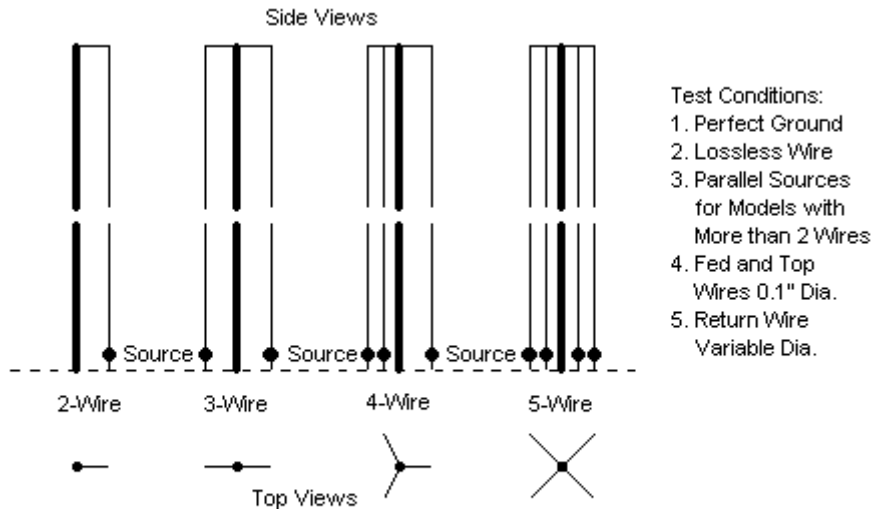

Configuration of Test Folded Monopole Models

Fig. 3

The outer wires will have a constant diameter, 0.1". I shall vary the diameter of the center or return wire in steps. Since a zero diameter is not possible, I shall use 0.1-Ohm as the minimum return wire diameter. The remaining steps will be linear: 0.25", 0.5", 0.75", and 1". I shall end the progression at this point for modeling reasons. As the diameter of the center conductor increases, the AGT score

departs ever further away from the ideal value. Using NEC-4, the value becomes unreliable more quickly than with MININEC (using a suitably corrected implementation of the public domain version 3.13), but both programs eventually fail to yield very usable results. However, we shall be able to track the requisite results over the range of selected values and arrive at some preliminary conclusions. The procedure is no less and perhaps no more approximate than the industry-standard practice of using single wire substitutes for complex geometries that more adequately reflect open tower structures. The AM BC industry regularly uses a wire radius of 0.37 times the face dimension of a triangular tower and 0.56 times the face of a square tower.

Besides varying the diameter of the return wire, the test models will also vary the center-to-center spacing between the return wire and the fed wire(s). I shall use spacing values of 12", 24", and 36". The top wires will use a diameter of 0.1", the same used for the fed wire. Each top wire will use a segment length of 1' (12"). The vertical wires will use 60 segments each, a value that produces segment lengths between about 0.9 and 0.95 of a foot. The very small disparity between the top-wire segment lengths and the vertical wire segment lengths does not jeopardize current calculations in NEC 4.1, since the feedpoint is in the lowest segment of each outer vertical wire. Tests using segment lengths that are as close to 12" as possible result in variations of the feedpoint impedance by no more than 0.02 Ohm relative to either the resistive or reactive component.

One aspect may be unique to these test models, although it is a common modeling practice. The uniqueness is the attention that we shall give to it. Most NEC modelers attempt to supply the model with a single feedpoint to end up with an overall impedance for the structure. There are a number of ways in which we can perform the feat. We might elevate the ends of the fed wires and provide shorting wires between legs ends. Then we may run a single wire to ground and place a source on this wire. Alternatively, we may run transmission lines to a remote wire and place a source on it. If we select a near-zero length for the transmission line lengths (which are independent of the actual distance to the remote wire), we effectively connect the four base segments in parallel.

In MININEC we must--and in NEC, we may--simply place sources at the ground end of each fed wire. Of course, the number of sources will be one less than the number of vertical wires in the model. A 5-wire cage monopole will have 4 sources. Since the impedance values for all of the sources will be identical, the net impedance will be the resistance and the reactance at each source divided by the number of sources. This derived value will be the same as the one we would produce by using the transmission-line technique of paralleling the sources. What differs is that we shall have--and pay close attention to--the source impedances of the individual fed wires.

The test will include 2-wire folded monopoles, even though we may calculate the impedance transformation ratio from the standard equation. We shall be as interested in how close the fit may be between the model and the equation result as for any other form of

folded monopole. A series of monopole models of lossless wire over perfect ground yields a resonant impedance of 36 Ohms. Hence, the reference impedance for each new combination of return wire diameter ( $d_2$ ) and spacing ( $s$ ) will be 36 Ohms times the equation-based ratio. We shall be comparing the modeled impedance values for each fed wire with the reference impedance value.

The test will initially yield reported values of source impedance. As well, each test will have an AGT score. Over perfect ground, the ideal AGT is 2.000, although the value is 1.000 in free space. The free-space equivalent of the ideal perfect-ground AGT is simple  $1/2$  the perfect-ground value. I shall use this free-space equivalent value in test reports, since it plays an important role in arriving at a usable impedance value. One reason for resonating the folded monopoles to such close tolerances is to allow us to use the AGT score to arrive at reasonably reliable values of resistive impedance.

However, with folded structures, we must alter NEC manual procedures somewhat. For a linear element--whether a dipole or a monopole--we normally multiply the AGT times the reported impedance to arrive at a corrected source impedance. The correction is most reliable when the impedance is virtually resistive. With folded dipoles and monopoles, we must reverse the correction procedure. To arrive at the usable impedance value, we must divide the reported impedance by the AGT score. As a matter of course, we shall also report the net impedance of the structure. More significant for our interests will be the ratio of the adjusted or corrected impedance value for each leg to the calculated 2-wire

impedance for a folded monopole having the wires and spacing applicable to a single fed wire and the center return wire.

## Some Test Results

**Table 1** provides the results for the series of modeling tests that I just described. The table lists 5 test sequences, each of which uses a different diameter for the inner, center, or return wire. The first column lists the 3 steps of spacing. The second column tells us the total number of vertical wires in the assembly. The number of fed wires is 1 less than the total. The third column lists the height in feet of the resonated skirt-fed monopole. The "Raw R" column lists the NEC 4.1 source resistance value before correction. The "Raw X" column provides a record of how close the model came to perfect resonance. The final column of raw data lists the AGT score using hemispherical increments of 5 degrees.

The remaining columns list the operations performed on the raw NEC data. The adjusted source resistance per leg results from dividing the raw resistance by the AGT score. The net source resistance appears in 2 columns, the first dividing the raw leg resistance by the number of source, the second dividing the adjusted leg resistance by the number of sources. The final column lists the ratio of the adjusted leg resistance to the calculated 2-wire impedance.

Folded Monopoles with 2, 3, 4, and 5 Wires: Skirt-Fed						Linear monopole modeled source R = 36.0 Ohms.			
Models use lossless wire and perfect ground.									
Test 1	Inner Wire 0.1" diameter; Outer Wire(s) 0.1" diameter					Net Source R		Ratio	
Space	No Wires	Res Ht ft	Raw R	Raw X	AGT	Adj R/Leg	Raw	Adj	Leg Res
		Calculated 2-Wire Source Resistance:				144			Adj/Calc
12" (1)	2	67.240	143.50	0.09	1.000	143.50	143.50	143.50	0.997
	3	66.650	148.60	-0.05	1.004	148.01	74.30	74.00	1.028
	4	66.300	172.70	-0.05	1.001	172.53	57.57	57.51	1.198
	5	66.070	201.50	-0.11	0.998	201.90	50.38	50.48	1.402
		Calculated 2-Wire Source Resistance:				144			
24" (2)	2	66.780	143.40	0.00	1.000	143.40	143.40	143.40	0.996
	3	66.030	150.00	0.05	1.004	149.40	75.00	74.70	1.038
	4	65.600	175.10	0.07	1.003	174.58	58.37	58.19	1.212
	5	65.320	204.90	-0.05	1.002	204.49	51.23	51.12	1.420
		Calculated 2-Wire Source Resistance:				144			
36" (3)	2	66.360	143.30	-0.04	1.000	143.30	143.30	143.30	0.995
	3	65.495	150.50	-0.01	1.004	149.90	75.25	74.95	1.041
	4	65.020	176.00	-0.08	1.003	175.47	58.67	58.49	1.219
	5	64.730	206.20	-0.07	1.002	205.79	51.55	51.45	1.429
Test 2	Inner Wire 0.25" diameter; Outer Wire(s) 0.1" diameter					Net Source R		Ratio	
Space	No Wires	Res Ht ft	Raw R	Raw X	AGT	Adj R/Leg	Raw	Adj	Leg Res
		Calculated 2-Wire Source Resistance:				174.36			Adj/Calc
12" (1)	2	67.135	170.20	-0.02	0.981	173.50	170.20	173.50	0.995
	3	66.581	163.60	-0.08	0.983	166.43	81.80	83.21	0.955
	4	66.250	184.70	-0.09	0.987	187.13	61.57	62.38	1.073
	5	66.032	211.90	-0.05	0.987	214.69	52.98	53.67	1.231
		Calculated 2-Wire Source Resistance:				170.19			
24" (2)	2	66.705	166.70	0.02	0.985	169.24	166.70	169.24	0.994
	3	65.978	163.70	-0.02	0.989	165.52	81.85	82.76	0.973
	4	65.560	186.30	-0.04	0.993	187.61	62.10	62.54	1.102
	5	65.290	214.90	-0.05	0.995	215.98	53.73	53.99	1.269
		Calculated 2-Wire Source Resistance:				168.24			
36" (3)	2	66.318	165.00	0.05	0.986	167.34	165.00	167.34	0.995
	3	65.464	163.60	-0.06	0.990	165.25	81.80	82.63	0.982
	4	65.000	186.80	0.05	0.995	187.74	62.27	62.58	1.116
	5	64.710	215.90	-0.08	0.996	216.77	53.98	54.19	1.288

Test 3	Inner Wire	0.5" diameter, Outer Wire(s) 0.1" diameter					Net Source R		Ratio
Space	No Wires	Res Ht ft	Raw R	Raw X	AGT	Adj R/Leg	Raw	Adj	Leg Res
		Calculated 2-Wire Source Resistance:				210.09			Adj/Calc
12" (1)	2	67.015	199.80	0.00	0.957	208.78	199.80	208.78	0.994
	3	66.505	179.20	0.01	0.957	187.25	89.60	93.63	0.891
	4	66.195	197.00	-0.01	0.958	205.64	65.67	68.55	0.979
	5	65.985	222.40	-0.07	0.973	228.57	55.60	57.14	1.088
		Calculated 2-Wire Source Resistance:				199.25			
24" (2)	2	66.615	191.30	0.00	0.966	198.03	191.30	198.03	0.994
	3	65.920	177.50	0.02	0.970	182.99	88.75	91.49	0.918
	4	65.520	197.60	0.06	0.980	201.63	65.87	67.21	1.012
	5	65.255	224.80	-0.01	0.986	227.99	56.20	57.00	1.144
		Calculated 2-Wire Source Resistance:				194.41			
36" (3)	2	66.255	187.40	0.02	0.970	193.20	187.40	193.20	0.994
	3	65.425	176.50	-0.01	0.974	181.21	88.25	90.61	0.932
	4	64.970	197.50	-0.06	0.984	200.71	65.83	66.90	1.032
	5	64.685	225.40	-0.06	0.989	227.91	56.35	56.98	1.172
		Calculated 2-Wire Source Resistance:				194.41			
Test 4	Inner Wire	0.75" diameter, Outer Wire(s) 0.1" diameter					Net Source R		Ratio
Space	No Wires	Res Ht ft	Raw R	Raw X	AGT	Adj R/Leg	Raw	Adj	Leg Res
		Calculated 2-Wire Source Resistance:				239.89			Adj/Calc
12" (1)	2	66.920	222.90	0.06	0.936	238.14	222.90	238.14	0.993
	3	66.440	190.80	-0.03	0.935	204.06	95.40	102.03	0.851
	4	66.150	206.10	0.05	0.952	216.49	68.70	72.16	0.902
	5	65.950	230.20	0.05	0.960	239.79	57.55	59.95	1.000
		Calculated 2-Wire Source Resistance:				222.22			
24" (2)	2	66.540	209.70	-0.09	0.951	220.50	209.70	220.50	0.992
	3	65.870	187.40	0.00	0.954	196.44	93.70	98.22	0.884
	4	65.480	205.60	-0.07	0.970	211.96	68.53	70.65	0.954
	5	65.225	231.90	-0.03	0.978	237.12	57.98	59.28	1.067
		Calculated 2-Wire Source Resistance:				214.58			
36" (3)	2	66.200	203.80	-0.02	0.957	212.96	203.80	212.96	0.992
	3	65.386	185.60	-0.08	0.961	193.13	92.80	96.57	0.900
	4	64.495	205.00	-0.03	0.976	210.04	68.33	70.01	0.979
	5	64.665	232.20	0.01	0.983	236.22	58.05	59.05	1.101



Test 5	Inner Wire 1.0" diameter; Outer Wire(s) 0.1" diameter						Net Source R		Ratio	
Space	No Wires	Res Ht ft	Raw R	Raw X	AGT	Adj R/Leg	Raw	Adj	Leg Res	
		Calculated 2-Wire Source Resistance:				267.23			Adj/Calc	
12" (1')	2	66.835	243.00	0.08	0.917	264.99	243.00	264.99	0.992	
	3	66.385	200.60	0.04	0.915	219.23	100.30	109.62	0.820	
	4	66.105	213.70	-0.05	0.937	228.07	71.23	76.02	0.853	
	5	65.916	236.70	0.07	0.948	249.68	59.18	62.42	0.934	
		Calculated 2-Wire Source Resistance:				242.39				
24" (2')	2	66.476	225.20	-0.07	0.937	240.34	225.20	240.34	0.992	
	3	65.829	195.60	0.10	0.940	208.09	97.80	104.04	0.858	
	4	65.450	212.20	0.01	0.960	221.04	70.73	73.68	0.912	
	5	65.200	237.80	0.03	0.970	245.15	59.45	61.29	1.011	
		Calculated 2-Wire Source Resistance:				231.97				
36" (3')	2	66.150	217.40	-0.03	0.945	230.05	217.40	230.05	0.992	
	3	65.355	193.10	0.00	0.950	203.26	96.55	101.63	0.876	
	4	64.920	211.10	-0.05	0.948	222.68	70.37	74.23	0.960	
Table 1	5	64.645	237.60	0.02	0.977	243.19	59.40	60.80	1.048	

The resonant antenna height has only suggestive utility beyond showing the trends that confirm the propriety of model construction. As we increase the number of wires or the diameter of the center return wires, or the spacing between any fed wire and the return wire, the resonant height decreases over perfect ground. Although the trends are true, the exact resonant height of an actual folded monopole will vary somewhat with the ground quality and the number of radials forming the ground system. The AM BC standard of 120 quarter-wavelength radials with shorter intervening radials remains applicable to all monopoles, whether linear or folded. With respect to the source impedance of an assembly, such a system best replicates perfect ground. (Of course, the overall ground quality plays a significant role in determining the far field patterns for the antenna.

The AGT values provide an indication of the reason for halting the systematic modeling venture with a 10:1 ratio between the return wire and each of the fed wires. As we increase the diameter of the return wire, the AGT score decreases. By a 10:1 ratio, the score reaches 0.915. Beyond this value, I would not fully trust the reliability of the reported data, even when applying the corrective to the per-leg source resistance value. The impedance transformation ratio for a 2-wire system is largely a function of the physical properties of the folded monopole. Hence, the use of a large diameter tower (or its equivalent 3- or 4-face open tower) with standard wire sizes for the fed cage structure becomes problematical from a modeling perspective. 0.1" diameter wire approximates AWG #10, a value that falls about halfway between AWG #12 and #14, popularly used by radio amateurs, and AWG #6, sometimes used by commercial installations.

The net adjusted source resistance columns indicate one reason why cage-fed or skirt-fed monopoles are finding proponents. As we add fed wires (symmetrically, of course) to a center return wire, the net source impedance of the parallel-fed outer wires brings down the overall source impedance. With equal-diameter wires for the fed and return legs, we have the familiar 4:1 up conversion of the impedance for each leg. As we increase the return wire diameter, the source impedance in each leg increases in step with standard expectations from the 2-wire equation, although we cannot obtain a precise number for more than a 2-wire system. Nevertheless, when we parallel the leg sources, the net impedance decreases as we increase the number of fed outer wires. For any given combination of fed and return wire sizes, increasing the spacing decreases the

net impedance. However, for any number of fed sources, increasing the return wire diameter increases the impedance. A 5-wire (4-source) cage indicates impedances that are close to optimal for direct coax feeding with either no matching or minimal matching requirements. Construction variables relative to both the cage and the return mast or tower, along with ground and radial system conditions will modify the values shown. Nevertheless, the trends are useful in system planning, even if NEC-4 models may fail to be reliable at the return structure diameter that might be used. For example, a triangular tower with a 12" face might show an equivalent diameter of 8.88", which--even with 36" spacing--would yield models of very dubious reliability.

For any given spacing and return-wire diameter, the per-leg source resistance shows a relatively tight grouping of values as we move from a 2-wire to a 5-wire folded monopole. About 50 Ohms separates the lowest from the highest value in each group. The variations within each group tend to suggest the level of mutual coupling among the fed wires and other interactions. Data patterns alone do not provide the details of the complex interactions. However, *the close proximity of the values within each group relative to the calculated impedance value for a 2-wire folded monopole strongly indicates that each fed wire and the return wire form a 2-wire folded monopole, modified in impedance performance by the interactions.* If each pair of wires in a complex multi-wire monopole forms a folded monopole, then we may legitimately call the entire structure, regardless of the number of cage or skirt wires, a folded monopole.

We may regroup the final columns of values that show the ratio of calculated to modeled values of per-leg source resistance and graph them by reference to the spacing between the fed wire and the return wire. **Fig. 4** shows the results for a spacing of 12". Each line represents one of the folded-monopole systems. The X-axis shows the increase in the return wire diameter. Note that the lowest value (0.1") is not a true linear increment relative to the other increments on the graph.

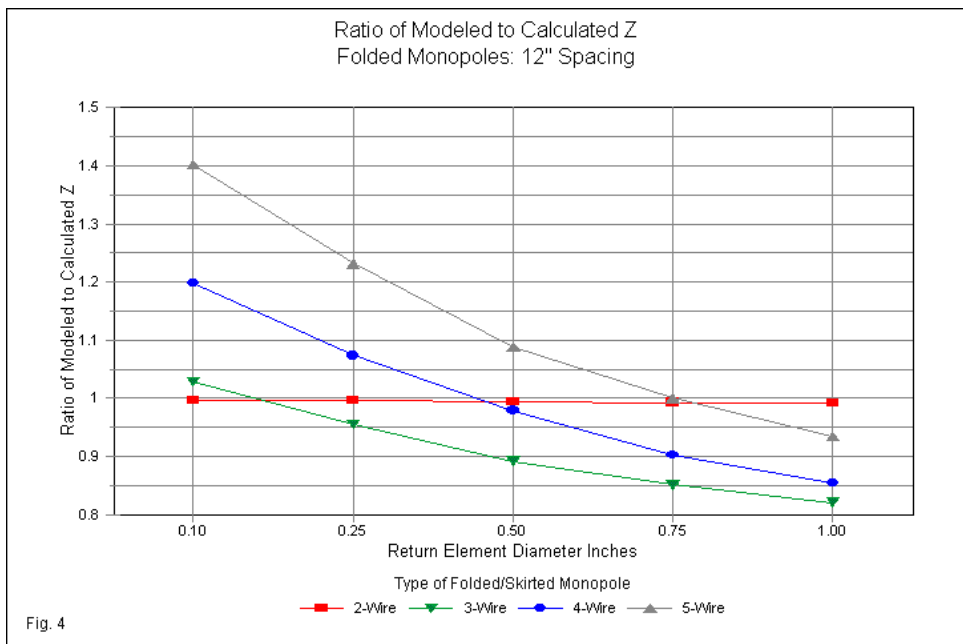

The 2-wire graphed line establishes that using corrected per-leg impedance values yields models that are always well within 1% of the calculated value of impedance. The per-leg values for 3-wire systems are always below those for 4-wire and 5-wire monopoles. For a spacing of 12", the lowest per-leg value is about 0.83 of the calculated 2-wire value. In contrast, the highest value is about 1.4 times the calculated value. Although these limits are fairly wide, each curve shows a much narrower range of departure from the calculated value, which the 2-wire curve indicates.

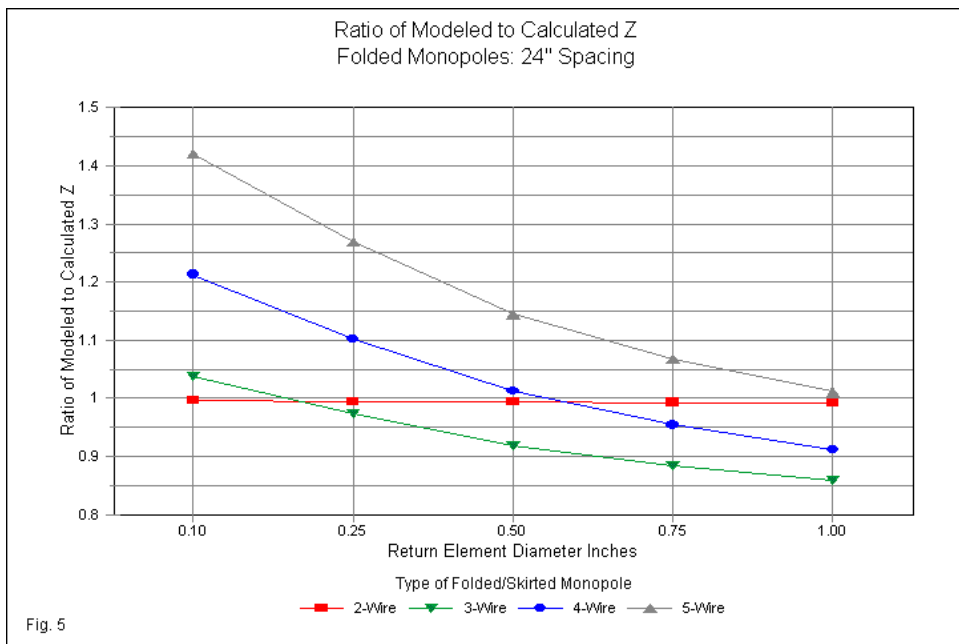

As we increase the spacing to 24", as shown in **Fig. 5**, the ratio of calculated to modeled adjusted per-leg impedance increases, except for the 2-wire model. It continues to show its tight correlation to the calculated impedance value. Perhaps only the effects of requiring a top wire prevent the ratio from reaching 1 to 1. The ratio values for the larger folded monopoles show slight increases for all of the more complex assemblies. Interestingly, about half of the data points fall above the 1:1 ratio lines, and half below it.

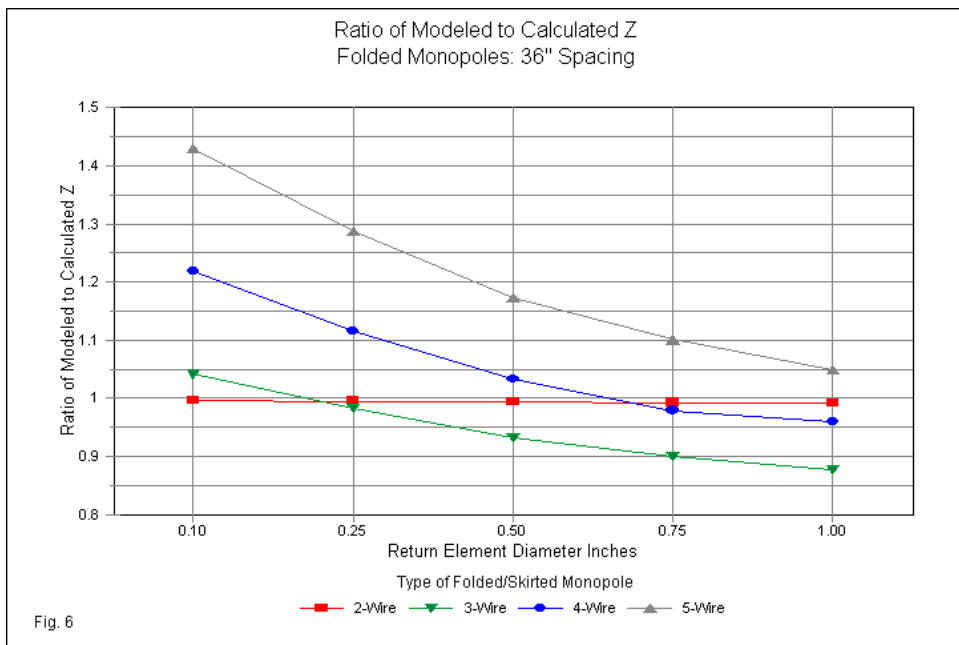

The graph for a spacing of 36" between the return wire and each fed wire appears in **Fig. 6**. The overall grouping has all of the properties that we saw in the preceding graphs. However, the majority of data points now fall above the 1:1 ratio line. The differences among the 3 graphs are not great, but they are noticeable as a function of the increased spacing.

Perhaps more interesting than the differences are the similarities among the graphs. For each size of folded-monopole assembly, regardless of spacing, the curve shapes are regular and similar. (Even the 2-wire curve shows a very slight drop in value as we increase the diameter of the return wire.) As well, the values within each graph show a relatively tight clustering around the calculated impedance value. 5-wire systems show the highest level of departure from the calculated value, a fact that appears to coincide with the closer proximity of the fed wires to each other. Determining the effects of mutual coupling would require a different sort of study from the present effort. In each case, I have resonated the total folded monopole system in order to arrive at as pure a resistive impedance as feasible. Interactive analysis of the wires might require a study using a set of fixed-length wires.

Nevertheless, the data shows that caged and skirted monopoles have their roots in 2-wire folded monopoles and are an extension of the basic structure. The variations are insufficient to deny the use of the term *folded monopole* as a generic label for all such structures.

In many ways, however, settling the terminological preferences of engineers has only been a pretext for the true point of these notes.

Too many amateurs are unfamiliar with the general properties of folded monopoles, both simple and complex. These notes represent one small attempt to fill the void and to acquaint the amateur with the range of labels that he or she might encounter in basic reading about these antennas. A secondary goal has been to show the nature and the limits of modeling these antennas using NEC-4. AGT values for NEC-2 versions of the models would be even worse. We might extend the range of the sampling of return-wire diameters by using a well-corrected version of MININEC 3.13, but even that program will eventually show less reliable results before we reach the tower dimensions that we might encounter in reality.

Nevertheless, the trends shown in these notes may be useful in establishing realistic expectations from multi-wire folded monopole assemblies. The data shown here cannot eliminate the need for extensive field adjustment, but they may go some distance toward reducing the time involved.



## Chapter 32: Short Folded Monopoles - Some Basics

In Chapter 31 defining Folded Monopoles, we examined some basic properties of resonant folded monopoles using 2, 3, 4, and 5 wire construction. When resonant, modeled folded monopoles show a clear relationship between the reported source impedance and the calculated impedance using the classical equation.

$$R = \left( 1 + \frac{\log \frac{2s}{d1}}{\log \frac{2s}{d2}} \right)^2$$

R is the ratio between the impedance of the new folded antenna and the impedance of a resonant linear antenna that otherwise has the same design. The equation applies equally to folded dipoles and to folded monopoles. Where the diameters of both the fed wire (d1) and the return wire (d2) are the same, the ratio is 4:1. The new impedance follows a very simple equation:

$$Z_{\text{folded}} = R \cdot Z_{\text{linear}}$$

Since the feedpoint (or source) impedance ( $Z_{\text{linear}}$ ) of a linear monopole over perfect ground is 36 Ohms, the resonant feedpoint impedance of a folded monopole ( $Z_{\text{folded}}$ ) is 144 Ohms. If the fed wire is fatter than the return wire, then the impedance ratio is less than 4 but always greater than 1. If the return wire is fatter than the fed wire, then the impedance ratio is always greater than 4.

The basic principles in our initial foray into folded monopoles neglected a very important aspect of folded monopole use. Many antenna builders use lengths that are shorter than the resonant length. For very short to moderate folded monopole lengths, (where the resonant length might be considered long), the feedpoint impedance will show an inductive reactance. In that property, a short folded monopole bears a resemblance to a transmission-line shorted stub. However, the stub and the antenna have some important differences, crudely marked in **Fig. 1**.

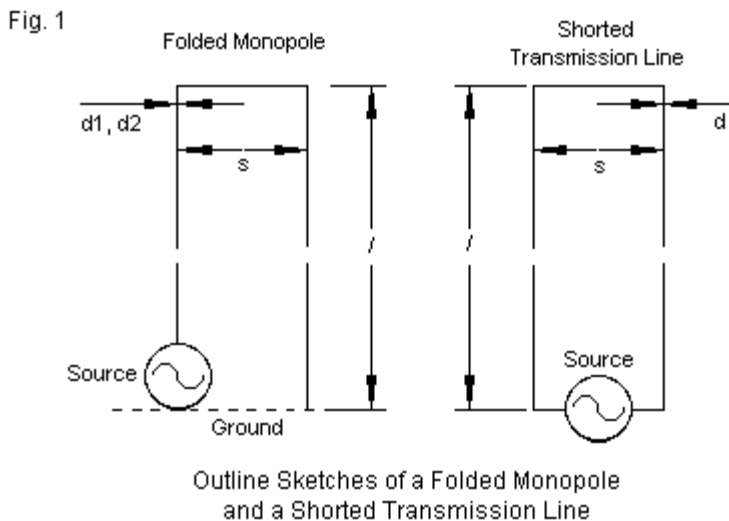

The two structures are similar in that the properties are dependent on the diameter of the wires and on the spacing between wires. The letters  $s$ ,  $d$ ,  $d_1$ , and  $d_2$  designate these fundamentals that

make performance dependent to a significant degree on physical properties of the structure. The folded monopole requires a ground (or a suitable ground plane) in order to operate. The energy source is normally positioned in series with the lower end of one wire ( $d_1$ ) and the ground. In contrast, the shorted stub uses no ground. Rather, the energy source is placed across the two wires of the transmission line opposite the shorted end. As a consequence, the shorted transmission-line stub does not radiate (if properly constructed and isolated from influences that would create imbalance between the lines). It ideally shows only transmission-line currents, which are equal in magnitude and opposite in phase at points along the line that are equidistant from the energy source. The folded monopole radiates and therefore exhibits both transmission-line currents and radiation currents.

At this point, we have to choose a direction for analyzing the behavior of short folded monopoles. We might legitimately turn to a mathematical treatment of the structures. However, my goal is not to replicate texts on the subject, but rather to familiarize you with the patterns of short folded monopole behavior. Therefore, my chosen route of analysis is modeling some selected folded monopoles to develop some patterns in the behavior. The method will be effective in showing some of the variables that influence the behavior, while also developing some rational expectations of them. We shall choose our modeling software to fit the structure that we are modeling. For our first two case studies, NEC-4 is adequate to the task, although we shall pay close attention to the Average Gain Test (AGT) score (where 1.000 is ideal) in order to adjust numbers as needed.

Since we shall not be dealing in resonant antenna lengths, we need an increment of folded monopole length to use for our samples. One convention used in the AM BC industry is to list antenna lengths in electrical degrees, where 1 wavelength equals 360 degrees. We may adopt this convention for physical lengths even though we know in advance that 90 degrees physical is longer than the resonant physical length that we would call 90 degrees electrical length. We shall survey folded monopoles every 10 degrees at a standard test frequency of 3.5 MHz for the entire exercise. To reduce the number of variables, we shall use lossless or perfect wire along with a perfect ground. As well, in this initial investigation, we shall work only with 2-wire folded monopoles.

### **Case 1: $d1 = d2 = 0.1"$ , $s = 12"$**

We may begin with a folded monopole structure already explored in the earlier item. We shall form a set of folded monopoles where both wires have a diameter of 0.1" and the spacing is 12" between them (center-to-center). The use of 0.1" diameter wire is not accidental. It roughly corresponds to AWG #10 wire, which falls between two practical extremes. Amateurs often used AWG #14 or #12 wire for such structures due to its availability and relatively low cost. Commercial installations may use wire that approximates AWG #6 (0.16").

At a resonant length of 67.25', the modeled impedance is 143.5 Ohms, compared to the calculated value of 144 Ohms. When we model the antennas in the collection in 10-degree increments, we

end up with a set of performance values such as those shown in **Table 1**.

Short Folded Monopole over Perfect Ground										Table 1
Case 1	El. Dia.	Space	Zo	Freq	WL	Res 1/4wl				
	0.1"	12"	657.22	3.5 MHz	281.02'	67.25'				
Len deg	Len ft	Resis	React	AGT	AGT dB	Gn broad	Gn edge	Gn Cu	Gn Al	
10	7.806	0.001361	124.0	1.011	0.05	2.01	4.75	-19.06	-20.88	
20	15.612	0.04345	265.2	1.001	0.00	4.47	4.80	-7.94	-9.69	
30	23.418	0.6345	470.9	1.000	0.00	4.75	4.82	-0.74	-2.13	
40	31.224	7.9	886.8	1.000	0.00	4.83	4.86	2.89	2.13	
50	39.031	281.0	2969.0	1.000	0.00	4.88	4.90	4.26	3.97	
60	46.836	415.3	-1976.0	1.000	0.00	4.94	4.96	4.75	4.64	
70	54.643	139.5	-571.8	1.000	0.00	5.01	5.03	4.95	4.90	
80	62.449	126.3	-170.7	1.000	0.00	5.09	5.11	5.06	5.04	
90	70.255	164.7	102.9	1.000	0.00	5.19	5.21	5.17	5.14	

Besides showing the length of each model in degrees and feet, the table lists the source resistance and reactance of each model. It also lists the AGT in terms of the score and the gain adjustment in dB (where the adjustment value is subtracted from the reported value). Because all but the 10-degree scores are very close to 1.000, the table makes no adjustments in this case.

There is much to note in the tabular data. We might begin with the gain values, which we show in terms of the gain broadside to the plane of the 2 wires and in terms of the maximum gain in line or edgewise to the 2 wires. Maximum gain occurs in the direction of the feedpoint. There is always at least a slight difference in the 2 values, but as we make the folded monopole shorter, the differential becomes very noticeable. **Fig. 2** compares the elevation patterns for 10-degree and 30-degree versions of the antenna. In each case, the plots overlay the patterns broadside and edgewise

to the wires. The shorter antenna shows a large difference that almost completely disappears by the time the antenna is 30 degrees long.

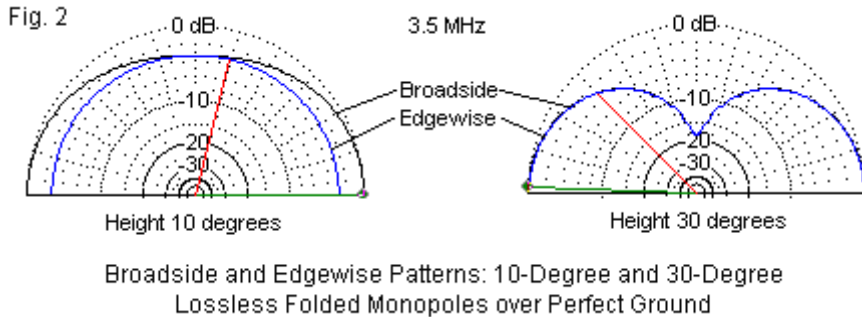

One way to make sense of the remaining data in the table is to contrast it to corresponding data for an equivalent linear monopole. Therefore, I created a model of a monopole that showed a resonant length of 67.25', the resonant length of the folded monopole. The model required a wire diameter ( $d$ ) of 2.75" to achieve this goal.

**Fig. 3** shows a sketch of the 2 antennas.

Fig. 3

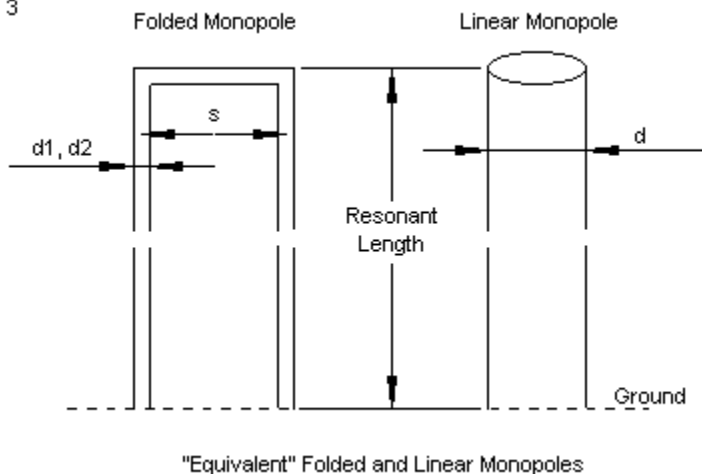

I then sampled the antenna in 10-degree intervals to produce a table comparable to the one for the folded monopole. The results of this exercise appear in **Table 2**. The columns in this table exactly parallel those of **Table 1**.

Short Linear Monopole over Perfect Ground								Table 2	
Case 1 Monopole Equivalent									
El. Dia.	2.75"								
Len deg	Len ft	Resis	React	AGT	AGT dB	Gn Perf	Gn Cu	Gn Al	
10	7.806	0.370	-1256.0	0.997	-0.01	4.77	4.74	4.73	
20	15.612	1.316	-680.2	0.999	0.00	4.79	4.77	4.77	
30	23.418	2.915	-457.9	0.999	0.00	4.81	4.80	4.80	
40	31.224	5.294	-328.4	1.000	0.00	4.85	4.84	4.84	
50	39.031	8.656	-236.6	1.000	0.00	4.89	4.88	4.88	
60	46.836	13.310	-163.0	1.000	0.00	4.94	4.94	4.94	
70	54.643	19.740	-98.4	1.000	0.00	5.01	5.01	5.01	
80	62.449	28.690	-37.4	1.000	0.00	5.09	5.09	5.09	
90	70.255	41.460	23.9	1.000	0.00	5.19	5.18	5.18	

Both tables list the gain of the antenna over perfect ground using 3 different wire compositions: perfect or lossless, copper, and aluminum. Copper has a bulk resistivity of about  $1.7E-8$  Ohms/meter (corresponding to a conductivity of about  $5.8E7$  S/m). Aluminum's resistivity is about  $4E-8$  Ohms/m (conductivity about  $2.5E7$  S/m). Antenna modeling programs adjust the material losses for frequency and skin affect in actual calculations. Hence, the gain values for perfect or lossless wire would reappear at any frequency, but the gain values will vary a bit as we change frequency if we use copper, aluminum, or any other real wire material.



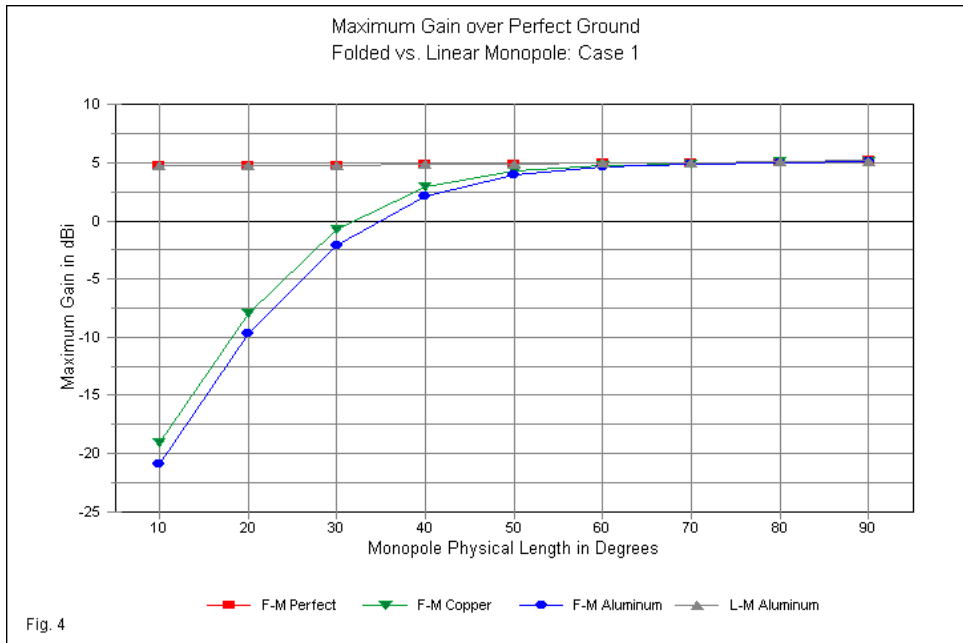

**Fig. 4** compares the gain values from the tables for all sampled lengths. The values for the 2.75" linear monopole are for aluminum only, since the differences between perfect wire and the worst case used in the sample are so small. However, with wires that are only 0.1" in diameter, the material losses of copper and aluminum are exceptionally significant as we reduce the overall length of a folded monopole. Below a length of about 50 degrees, the thin-wire folded monopole shows a rate of gain decrease that may question the practicality of using such a thin, short structure as an antenna

without specific needs that make the highly reduced gain acceptable as a trade-off.

At resonant length, the folded monopole may rival the linear monopole, but at very short lengths, the very low source radiation resistance becomes only a small fraction of the total source resistance. The wires are too thin to overcome the resistive losses of the material and of skin effect. With real wire, the 10-degree folded monopole shows less than 1% power efficiency. For the shortest thin-wire folded monopoles in the sample, the use of phosphor bronze or stainless steel would increase losses even further.

The monopoles that we have examined are over perfect ground. Placing them over real (lossy) ground will further reduce the gain available (as well as raising the elevation angle of maximum radiation). **Table 4** provides a rough guide to the amount of further gain reduction we are likely to experience over three levels of ground quality. Very good soil has a conductivity of 0.0303 S/m and a relative permittivity of 20. Average soil uses a conductivity of 0.005 S/m and a relative permittivity of 13. Very poor soil uses a conductivity of 0.001 S/m with a relative permittivity of 5. These widely diverse soil types may let you approximate the additional losses of your local soil by rough interpolation. The radial systems use 0.1" wire buried 1' below the ground surface in the NEC-4 models.

Approximate Gain Reduction for Placing Monopoles over Real Ground with Buried Radials				
Radials		VP	AV	VG
4		-9.63	-6.75	-3.80
8		-8.02	-5.95	-3.47
16		-6.93	-5.29	-3.18
32		-6.43	-4.84	-2.95
64		-6.25	-4.62	-2.78
128		-6.17	-4.54	-2.69
VP = Very Poor (c = 0.001, p = 5)				
AV = Average (c = 0.005, p = 13)				
VG = Very Good (c = 0.0303, p = 20)				Table 4

The table is only a first-order estimation device, not a precise gauge. For increased accuracy, you would need to model a proposed short folded monopole using both the actual material and the actual ground conditions at the proposed site--along with a model of whatever buried radial system the antenna might use.

Linear monopoles have gained some renown for their low feedpoint resistance values when they are very short. However, if you compare **Table 1** with **Table 2**, you will discover that the feedpoint resistance of the folded monopole does not catch up to the feedpoint resistance of the linear monopole until we reach a total length of about 40 degrees for both antennas. **Fig. 5** compares the feedpoint resistance values for both antennas across the span of surveyed heights.

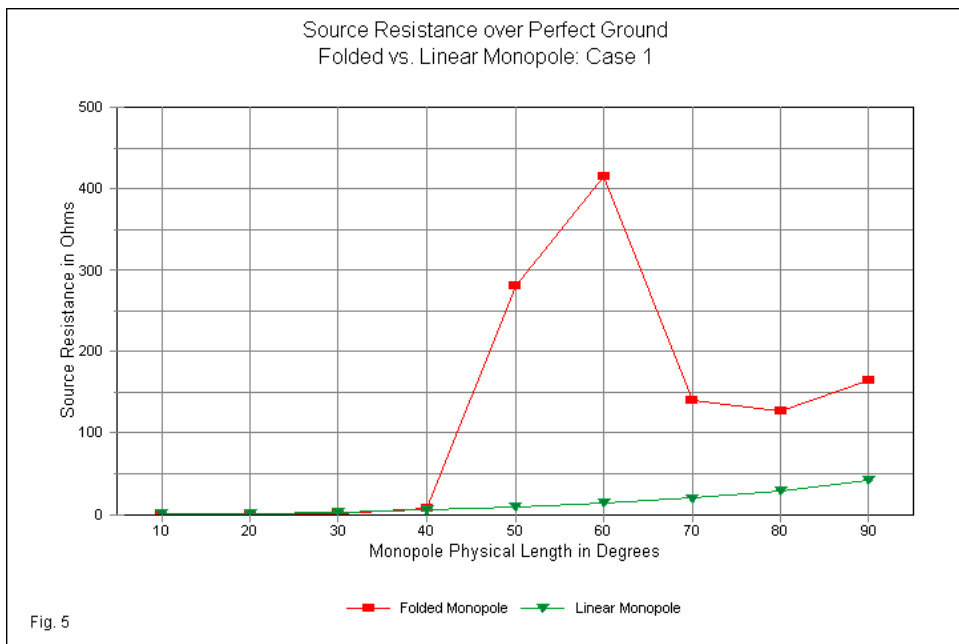

The linear monopole resistance values show a smooth progression from 10- through 90-degree lengths, reaching a final value of about 41 Ohms. However, the folded monopole shows a very large spike in values between 50 and 60 degrees. The actual peak value is much higher than the largest graphed value, since the peak occurs at a height of about 57 degrees. Then the resistance value decreases rapidly so that between 80 and 90 degrees, it shows an expected slight rise with increasing length in this region. Even at 90 degrees, somewhat beyond resonance, the resistance is 164 Ohms, about 4 times the linear value for the same length.

The peaking of the resistance value accompanies a peaking of the reactance value in folded monopoles. **Fig. 6** graphs the reactance for both the folded and the linear monopole as we increase the length from 10 to 90 degrees.

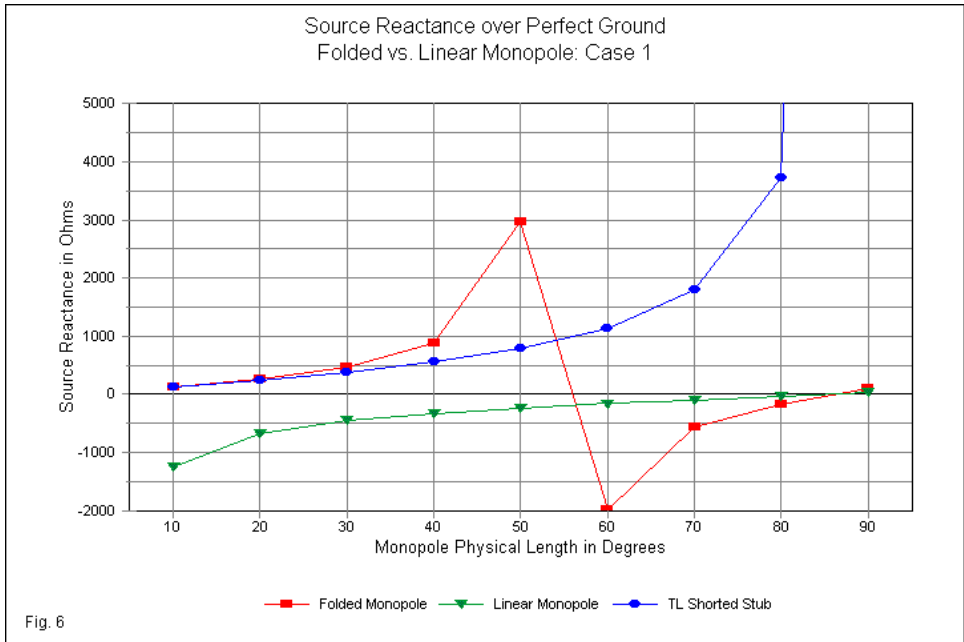

The linear monopole shows a smooth curve that traces the decreasing capacitive reactance as the antenna lengths increases toward resonance. Since the 90-degree length is long relative to resonance, the curve smoothly proceeds into the region of inductive reactance. In contrast, the folded monopole shows very high values

of reactance at 50 and 60 degrees. One may interpolate a sudden shift in reactance type at about the length at which the resistance reaches its maximum value. Of course, at this point, we would find a very small region of height at which the reactance would be nearly zero. However, that specific height is unlikely to be achieved in any practical installation. Even if achieved, a slight temperature change would alter the antenna height enough to throw the reactance into a high value region--either inductive or capacitive, depending on the direction of the temperature shift.

The very high value of resistance and the sudden shift of reactance from inductive to capacitive are typical behaviors of horizontal antennas as they pass the 1-wavelength mark or of ideal vertical monopoles as they pass through the 1/2-wavelength mark. However, the folded monopole is less than 0.16-wavelength long.

**Fig. 6** contains reactance values for one extra case: a shorted transmission-line stub constructed according to the same wire diameters and spacing values that we used for the folded monopole. I arbitrarily cut off the table at +j5000 Ohms since the reactance value of a shorted stub increases without limit at exactly 90 degrees. **Table 3** shows the calculated values of the stub's reactance at the line lengths that correspond to the folded monopole's lengths in the survey.

Shorted Transmission-Line Stub		Table 3	
El. Dia. = 0.1"		Space = 12"	
Fr = 3.5 MHz		WL = 281.02 ft	
Len deg	Len rad	Len ft	XL
10	0.175	7.806	115.886
20	0.349	15.612	239.209
30	0.524	23.418	379.446
40	0.698	31.224	551.473
50	0.873	39.031	783.244
60	1.047	46.837	1138.338
70	1.222	54.643	1805.697
80	1.396	62.449	3727.280
90	1.571	70.255	1.1E+19
45	0.785	35.128	657.22

The table rests on calculating the characteristic impedance ( $Z_o$ ) from the physical dimensions of parallel wires, as indicated in **Fig. 1**. One common equation for the calculation uses common logs.

$$Z_o = 276 \log \left( \frac{2s}{d} \right)$$

However, there is a more precise equation that uses natural logs.

$$Z_o = 120 \cosh^{-1} \left( \frac{s}{d} \right) = 120 \ln \left[ \frac{s}{d} + \sqrt{\left( \frac{s}{d} \right)^2 - 1} \right]$$

For the case in point, the impedance is high enough (657.22 Ohms) that the two equations yield essentially the same results. The more

precise equation becomes essential where the wire spacing is very close. Our 12" spacing is not close for 0.1" diameter wires. To calculate the inductive reactance of the stub, we may use another common equation. The  $l$  term represents the line length in electrical degrees (or radians).

$$X_L = Z_0 \tan l$$

The shorted transmission line that uses 0.1" diameter wires and a 12" spacing has a calculated characteristic impedance ( $Z_0$ ) of 657.22 Ohms. For any given length, the inductive reactance is a direct function of the  $Z_0$  value, and that value always appears as the inductive reactance at a length of 45 degrees for lossless lines.

I note these equations only to supply the basis for the tabular and graphical results shown. They suffice to show that the source impedance behavior of the short folded monopole--at least for the sample used here--is quite unlike the behavior of a linear monopole and the behavior of a shorted transmission line stub. To test these behaviors and to check for any variability, we need at least one more sample.

### **Case 2: $d_1 = d_2 = 0.5"$ , $s = 12"$**

As a check on our work, let's sample a second folded monopole through the same total height steps. In this case, we shall increase the wire diameter to 0.5", a 5-fold increase over the initial sample folded monopole. The increased wire diameter applies to all parts



of the antenna and so will have no effect on the impedance transformation ratio. The resonant impedance of a modeled antenna was  $143.1 - j0.1$  Ohms at a height above perfect ground of 66.81' (or 99.3% of the height of the resonant version of the first model).

Although the use of fatter wires with a 1' spacing does not change the folded monopole impedance transformation ratio, it does change the characteristic impedance of the line if used in a shorted stub configuration. The new  $Z_0$  is 464.17 Ohms (compared to 657.22 Ohms for the version using 0.1" diameter wires). For reference, **Table 5** presents the calculated inductive reactance values for the sampled lengths of the stub in 10 degree increments. The 45-degree entry allows a quick reference to the line  $Z_0$ .

Shorted Transmission-Line Stub			Table 5
El. Dia. = 0.5"		Space = 12"	
Fr = 3.5 MHz		WL = 281.02 ft	
Len deg	Len rad	Len ft	XL
10	0.175	7.806	81.846
20	0.349	15.612	168.944
30	0.524	23.418	267.989
40	0.698	31.224	389.486
50	0.873	39.031	553.177
60	1.047	46.837	803.968
70	1.222	54.643	1275.299
80	1.396	62.449	2632.445
90	1.571	70.255	7.6E+18
45	0.785	35.128	464.171

Except for the lowest 2 heights (10 and 20 degrees), the NEC-4 models of the antenna produce excellent AGT values. Hence, they require no adjustment in the tabular data. **Table 6** provides the information gathered from the test runs using the same format and column entries that we used for the thinner model.

Short Folded Monopole over Perfect Ground											Table 6
Case 2	El. Dia.	Space	Zo	Freq	WL	Res 1/4wl					
	0.5"	12"	464.171	3.5 MHz	281.02'	67.25'					
Len deg	Len ft	Resis	React	AGT	AGT dB	Gn broad	Gn edge	Gn Cu	Gn Al		
10	7.806	0.00117	86.9	1.018	0.08	2.17	4.85	-12.67	-14.45		
20	15.612	0.03135	184.5	1.003	0.01	4.36	4.81	-2.80	-4.34		
30	23.418	0.4203	320.7	1.000	0.00	4.72	4.83	2.46	1.61		
40	31.224	4.6	570.2	1.000	0.00	4.82	4.86	4.21	3.91		
50	39.031	90.8	1434.0	1.000	0.00	4.88	4.91	4.72	4.63		
60	46.836	943.3	-2399.0	1.000	0.00	4.94	4.97	4.91	4.88		
70	54.643	159.0	-505.9	1.000	0.00	5.04	5.09	5.02	5.01		
80	62.449	129.5	-135.2	1.000	0.00	5.10	5.12	5.11	5.11		
90	70.255	167.9	101.5	1.000	0.00	5.19	5.22	5.21	5.21		

To facilitate comparisons, I also created a linear monopole over perfect ground. I selected an element diameter that would achieve resonance at the same height (66.81') as the folded monopole in question in order to develop a relatively fair comparator. The required diameter was 5". The diameter is 1.8 times the diameter (2.75") of the comparison linear monopole used for the folded monopole with 0.1" elements. Both folded monopoles use the same center-to-center wire spacing. The exercise establishes that finding an equivalent linear monopole diameter to a given folded monopole structure requires attention to the wire diameter as well as to the wire spacing of the original folded structure.

Short Linear Monopole over Perfect Ground Case 2 Monopole Equivalent								Table 7
El. Dia. 5.0"								
Len deg	Len ft	Resis	React	AGT	AGT dB	Gn Perf	Gn Cu	Gn Al
10	7.806	0.369	-1026.0	0.998	-0.01	4.77	4.75	4.75
20	15.612	1.304	-573.4	0.999	0.00	4.79	4.78	4.78
30	23.418	2.890	-391.6	0.999	0.00	4.81	4.81	4.81
40	31.224	5.262	-283.2	1.000	0.00	4.85	4.84	4.84
50	39.031	8.637	-204.9	1.000	0.00	4.89	4.89	4.89
60	46.836	13.350	-141.2	1.000	0.00	4.95	4.94	4.94
70	54.643	19.910	-84.6	1.000	0.00	5.01	5.01	5.01
80	62.449	29.140	-30.5	1.000	0.00	5.10	5.09	5.09
90	70.255	42.440	24.4	1.000	0.00	5.19	5.19	5.19

**Table 7** shows the linear monopole data, again using the format established earlier. Of course, the linear monopole requires only one gain figure, since the pattern is uniform in all azimuth directions. Our initial comparisons will be internal to the new sample. We shall make cross-sample comparisons a bit later.

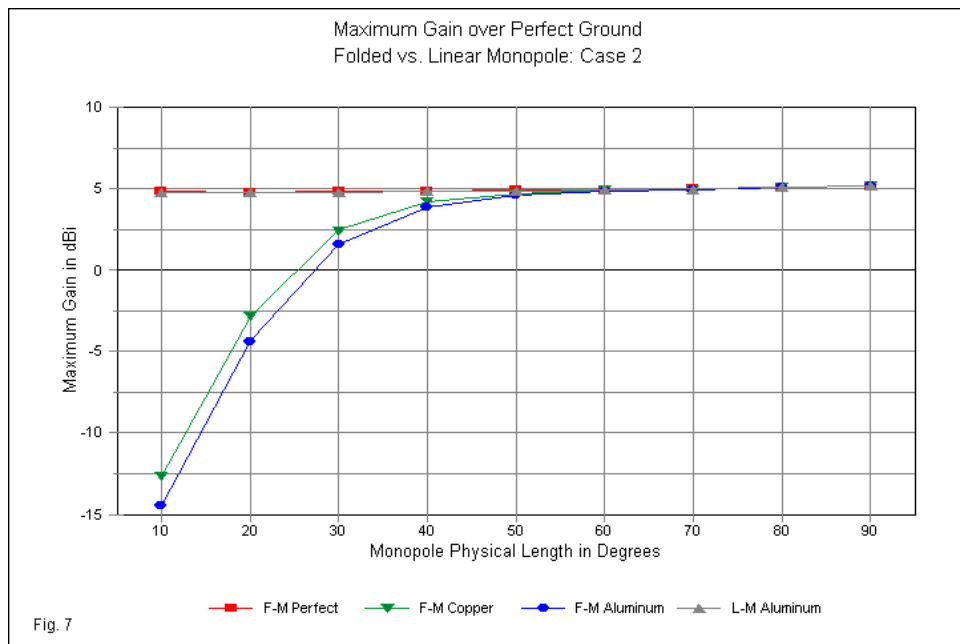

The relative gain values appear in **Fig. 7**. Since the gain of the linear monopole varies so inconsequentially over the range of real materials, the aluminum gain curve suffices as a substitute for 3 overlapping lines. The pattern of gain deficiencies with real materials for the folded monopole below a length of about 50 degrees reappears in this graph and in the tabular data. However, the 5-fold increase in folded monopole wire diameters shows up as a significant reduction in the deficiency level.

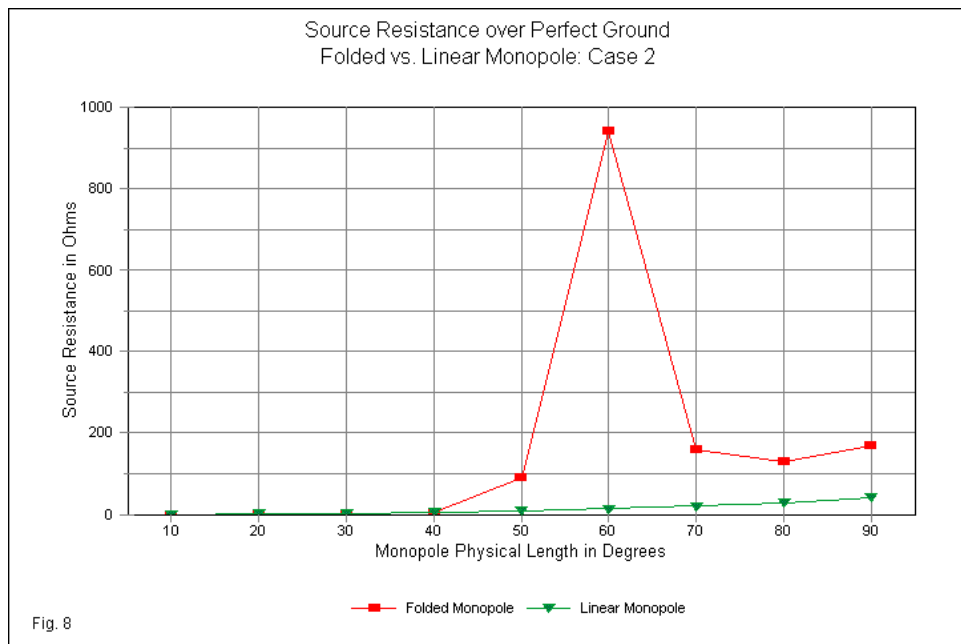

In **Fig. 8** we find the comparison of linear and folded monopole source resistance values. The linear monopole resistance increases in a regular (but not linear) fashion. In contrast, the folded monopole shows a very sharp peaking of resistance at about 60 degrees. The position of the adjacent resistance values suggests that the true peak may be at a length very close to 60 degrees.

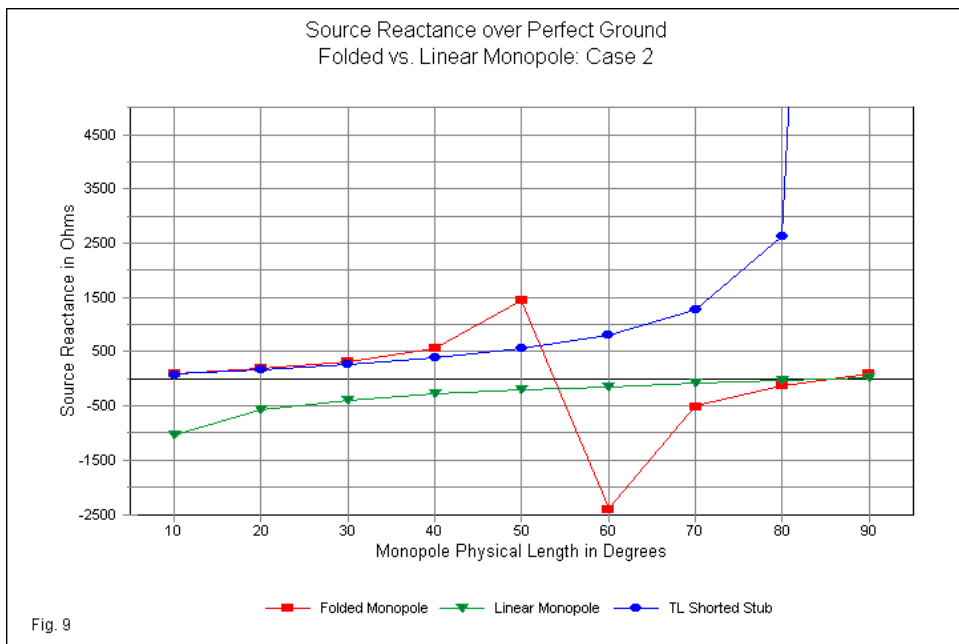

**Fig. 9** tracks the progression of reactance values. One line shows the inductive reactance of a shorted transmission-line stub. As I did earlier, I cut off the Y-axis arbitrarily, since the 90-degree reactance value increases without limit. (The tables show an exceptionally high but not limitless value for 90 degrees due to computer conventions for avoiding errors.) In contrast, the linear monopole shows a continuous, regular decrease in the capacitive reactance as the antenna grows toward its resonant height. Of course, at a physical height of 90 degrees, the antenna is slightly long relative to resonance, and so we find an inductive reactance.

The reactance curve for the folded monopole shows peak values of reactance at 50 and 60 degrees, with a transition region between them. The actual transition region is very small, as the reactance on either side climbs to values much higher than those recorded at the sampling points. In the length region that is about +/-10 degrees either side of resonance, the reactance curve shows a seemingly normal curve that moves from capacitive to inductive as we pass through the resonant folded monopole length.

## A Tentative Comparison of Two Folded Monopoles

We have looked individually at two folded monopoles that use the same 12" center-to-center wire spacing. The only difference between them is the diameter of the wires: 0.1" vs. 0.5". Hence, the impedance transformation ratio for both monopoles at a resonant height is the same: 4. Since a linear monopole using either wire diameter--or using the equivalent diameters in the comparators--has a resonant impedance of 36 Ohms (+/- 0.03 Ohm), we expect a resonant folded monopole impedance of 144 Ohms. The thin and thick folded monopoles show 143.5 and 143.1 Ohms, respectively. We may consider these values to be very much on target, given the fact that our basic impedance transformation equation does not take into account the diameter or the length of the end wires. The models cannot exist without taking these end-wire factors into account.

When we look at short folded monopoles using the same basic structure, we have to recognize that we cannot expect a precise equivalence. The length increments use the physical length of the

structure, not the electrical length relative to the resonant length. The 0.1" antenna was resonant at a length of 67.25', while the 0.5" version resonated at 66.81'. However, the lengths are less than 1% apart, which minimizes any differentials in this area of concern.

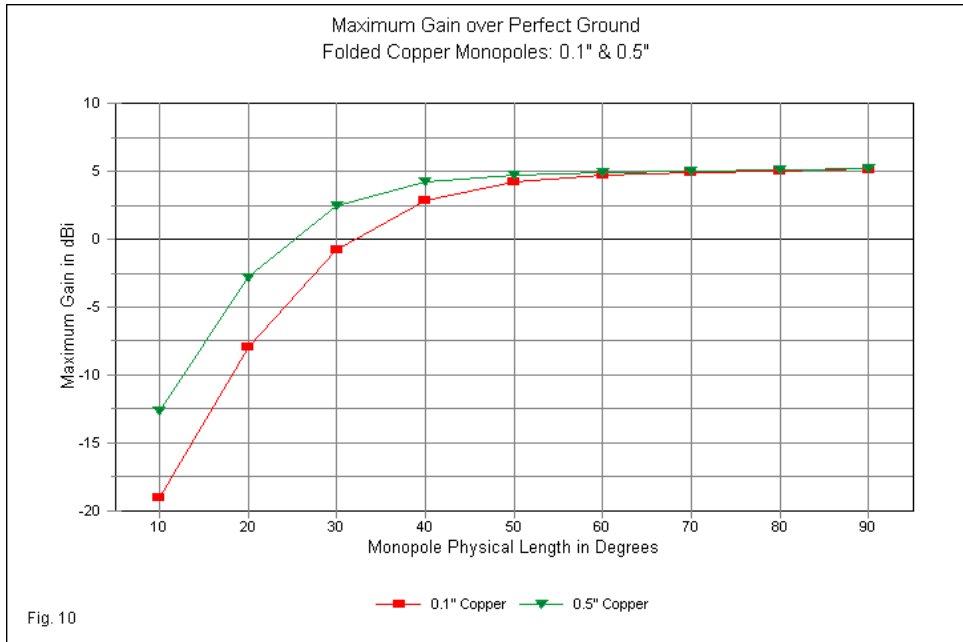

For a sample of the gain differential, **Fig. 10** compares the modeled maximum gain edgewise to the wires for both folded monopoles using copper wire. The thinner-wire folded monopole shows a 7-dB gain deficit compared to the fatter-wire model at the shortest length. As we increase the length of the folded monopole, the gain



difference decreases in a smooth curve so that by the time we reach a length of 50 or 60 degrees, the differential disappears (depending on our standard of when a differential is too small to be notable). The root source of the differential lies in skin effect. In small loop antennas, builders commonly use the largest practical conductor (sometimes round, sometimes flat) to reduce to the lowest possible level any losses due to the resistivity of real materials. The losses of the linear monopoles suggest that a wire diameter of well over 2" may be needed by folded monopoles shorter than about 50 degrees in order to reduce these losses effectively. Unfortunately, such diameters are not practical for NEC-4 models.

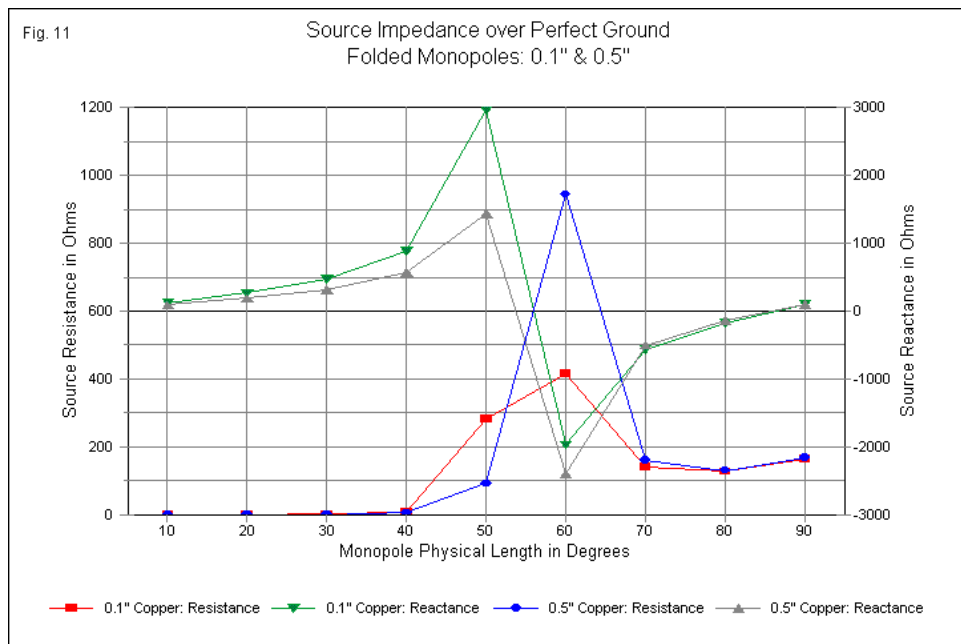

**Fig. 11** superimposes the source resistance and the reactance curves for the two folded monopoles. Due to the paucity of sampling points, the peak values appear to coincide. However, such curves can be somewhat misleading if we seek more than general guidance. Let's look at each folded monopole.

*0.1" Model:* A series of models using finer length graduations set the height at which the reactance passes through zero at about 42.321' or 54.215 degrees. The resistance in the immediate length region rose to 19540 Ohms. The length of the folded monopole was

about 62.9% of a resonant version or about 0.157-wavelength electrically.

*0.5" Model:* A similar series of models produced a height of 44.270' or 56.711 degrees at which the reactance passed through zero. At this height, the source resistance report was 10480 Ohms. However, the source resistance peaked (10510 Ohms) at about 44.235' or 56.667 degrees. The zero-reactance model was about 66.26% of a resonant version of the antenna or about 0.166-wavelength electrically.

We may note several interesting items about these numbers after observing a significant caution. The numbers derive from models that show an ideal AGT score, but which remain subject to all of the limitations to which the antenna modeling software (NEC-4) is subject. Hence, the numbers are useful for comparisons, but not necessarily for trying to build a short, resonant, very-high impedance folded monopole.

The thinner-wire folded monopole shows a much higher peak source resistance than the fatter-wire model. In fact, the ratio of peak source resistance values is 1.86:1. Although the tests did not specifically seek out the peak values of reactance that occur on the limits of the transition region, the thinner folded monopole appeared to reach values at least 1.6 times higher than the thicker model in the sequence of test model height. In both cases, the transition region was about 2 degrees of height, 56-58 degrees for the 0.5" model and 53 to 55 degrees for the 0.1" model. The transition region includes heights at which the initial peak inductive reactance

value begins to decrease and--at the opposite end--the height at which the capacitive reactance increases toward but does not reach its peak value.

The height at which the folded monopoles pass through zero reactance seems initially counter-intuitive, since we might expect the folded monopole using fatter element wires to pass that point at a shorter height in keeping with the slightly shorter height of a 1/4-wavelength resonant version. As well, the 0.5" model's slight difference between the zero-reactance height and the maximum source resistance height may also seem somewhat counter-intuitive to our understanding of high-impedance resonant points. In both cases, the most likely candidate to serve as the source of these interesting results is the end wire. The potential corner coupling of the 0.5" model might account for both phenomena. However, the models are not self-explanatory in this regard. As well, we cannot say from the model alone whether the phenomenon is an artifact of modeling or a real phenomenon. Models that mix wire diameters at angular junctions quickly become unreliable in NEC (both -2 and -4).

The differences in behavior between the two folded monopoles using equal legs, but of a different size for each model, are small. More significant is the general behavior trends that show the progression of antenna behavior with increasing length. First, the very low source resistance of shorter lengths (up to and perhaps beyond 30 degrees) results in a very lossy structure when using real materials of even the finest quality. Second, the very high impedance resonance in the 54- to 56-degree region is notable for

both its potentials and its limitations relative to using a short folded monopole. The short folded monopole acts neither like a shorted transmission line nor like a short linear monopole.

### Short Folded Monopoles with Dissimilar-Diameter Legs

Many folded monopoles make use of an existing structure for one leg and add a wire for the second leg. At resonant 1/4-wavelength sizes, we expect the monopoles to closely approximate calculated values of source impedance. We can do some initial modeling to see what happens as we sample shorter lengths, but we cannot do so reliably within NEC. We must turn to a version of MININEC. For the following examples, I used Antenna Model, a highly corrected version of MININEC 3.13. Fortunately, the program provides AGT scores as a matter of course.

To limit the stresses upon the limitations of the core, we may restrict our initial investigation of folded monopoles with unequal leg diameters to only 2 leg sizes: 0.1" and 0.5", the sizes that we used in the first two cases. As shown in **Fig. 12**, the top wires for the new cases will use the thinner wire size. The black dots represent the location of the model source. In NEC, we generally construe the source location to be along or at the center of the lowest segment in the relevant leg. In MININEC, the source is at the junction of the leg with the ground.

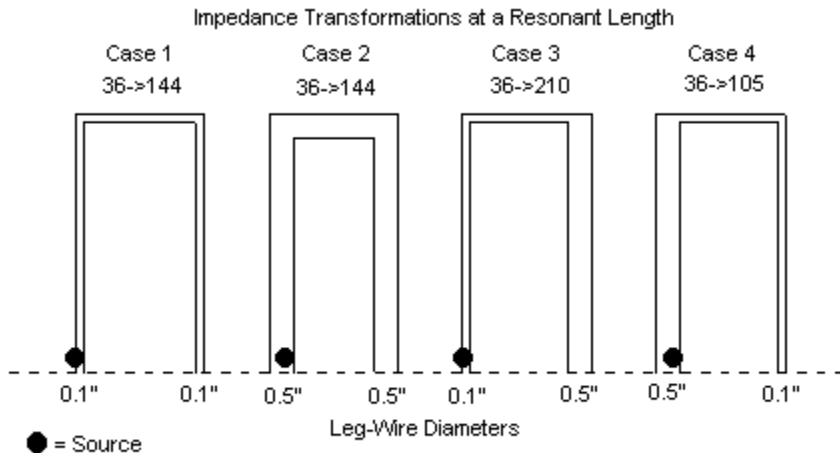

Short Monopole Cases Included in This Survey

Fig. 12

The ratio of leg diameters is 5:1. However, the equation that calculates the impedance transformation does not use that ratio directly, but incorporates the leg diameter within a ratio with twice the space between legs and then takes the common log of both space-diameter ratios. Hence, the resonant linear monopole source resistance becomes (by calculation) about 210 Ohms when we feed the thinner leg and about 105 Ohms when we feed the fatter leg. The proximity of modeled impedances to the calculated ones becomes a second test (in addition to the model's AGT) of the reliability of the reported data on the short folded monopoles.

Short Folded Monopole over Perfect Ground							Table 8	
Case 3	El. Dia.	Fed	Return	Space	Freq	WL	Res 1/4wl	
		0.1"	0.5"	12"	3.5 MHz	281.02'	67.25'	
Len deg	Len ft	Resis	React	AGT	AGT dB	Gn broad	Gn edge	
10	7.806	0.00107	100.2	0.994	-0.03	2.54	2.54	
20	15.612	0.02567	215.8	0.998	-0.01	4.24	4.79	
30	23.418	0.3274	370.0	1.000	0.00	4.69	4.82	
40	31.224	3.3	628.1	1.000	0.00	4.81	4.86	
50	39.031	44.3	1308.1	1.000	0.00	4.88	4.91	
60	46.836	11300.0	-2827.5	1.000	0.00	4.94	4.97	
70	54.643	282.9	-882.6	1.000	0.00	5.01	5.04	
80	62.449	191.3	-223.8	1.000	0.00	5.09	5.12	
90	70.255	244.1	144.1	1.000	0.00	5.19	5.22	
45	35.128	11.0	864.4	1.000	0.00	4.85	4.88	
Res Len	67.080	208.9	0.0	1.000	0.00	5.15	5.18	

**Table 8** provides the data for the version of the folded monopole with the source located on the thinner wire, Case 3. The table omits information on gain values for real wire materials, since that information would largely parallel the data for Cases 1 and 2. The perfect-ground gain data generally parallels the corresponding information for folded monopoles with equal-diameter legs. However, the broadside-to-edgewise gain differential is slightly greater. Although the impedance information for the shortest length appears quite reasonable and the AGT is only slightly off ideal, the gain data appears to need further study before we accept it at face value. In the following notes, gain will not be our main focus.

Short Folded Monopole over Perfect Ground							Table 9	
Case 4	El. Dia.	Fed	Return	Space	Freq	WL	Res 1/4wl	
		0.5"	0.1"	12"	3.5 MHz	281.02'	67.14'	
Len deg	Len ft	Resis	React	AGT	AGT dB	Gn broad	Gn edge	
10	7.806	0.00148	101.8	1.000	0.00	2.20	4.77	
20	15.612	0.0534	229.2	1.000	0.00	4.51	4.79	
30	23.418	0.8848	432.7	1.000	0.00	4.75	4.82	
40	31.224	14.8	947.6	1.000	0.00	4.83	4.86	
50	39.031	15224.9	7898.5	1.000	0.00	4.89	4.90	
60	46.836	140.2	-907.4	1.000	0.00	4.94	4.96	
70	54.643	84.8	-348.2	1.000	0.00	5.01	5.03	
80	62.449	89.0	-110.4	1.000	0.00	5.09	5.11	
90	70.255	121.7	71.9	1.000	0.00	5.19	5.21	
45	35.128	104.8	1886.4	1.000	0.00	4.86	4.88	
Res Len	67.080	104.5	0.0	1.000	0.00	5.15	5.17	

**Table 9** presents the comparable data for Case 4, which feeds the 0.5" leg of the folded monopole. Although the AGT scores are virtually ideal (at least through 3 decimal places), the gain data is subject to further scrutiny. However, the broadside-to-edgewise gain values more closely parallel those we obtained from the first two cases.

Whatever the reservations we may apply to the gain data, the most significant data resides in the resistance and reactance columns of the tables. Like the equal-diameter cases, both of the new cases shows exceptionally low source resistance values at the shortest lengths. The tables provide an entry for the resonant length information. In both new cases, the modeled resonant impedances are within 1/2 of 1% of the calculated values.



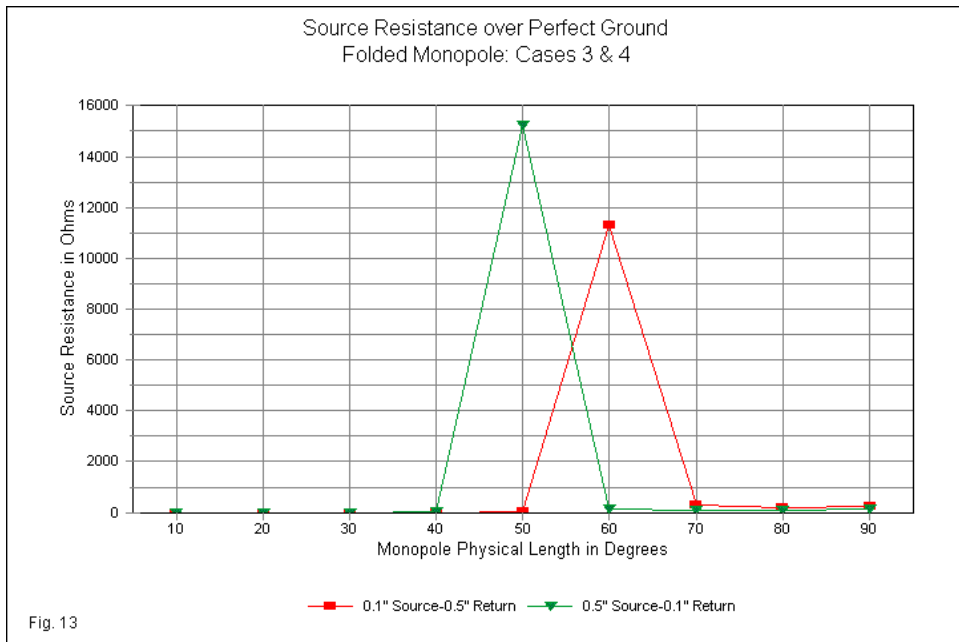

The curiosity of the folded monopoles with unequal leg diameters appears clearly in **Fig. 13**. When we feed the thinner wire, the source resistance peaks close to 60 degrees, or higher than either of the length values that we found in the first two models with equal-diameter legs. In contrast, when we feed the fatter leg, the length that shows peak source resistance is closer to 50 degrees. This length is shorter than we found for the first two cases.

Due to the very high peak resistance values, the lower source resistance values form almost straight lines, forcing us back to the

tables for the interesting properties. When we feed the thinner leg of the folded monopole, we discover a very rapid increase in impedance, beginning at a thousandth of an Ohm and climbing in a span of about 0.16 wavelength to an exceptionally high value. Predicting the source resistance of a physical version of the short Case-3 folded monopole would be a daunting task at best. Even temperature changes might yield significant resistance excursions at the feedpoint unless we use a wideband or a lossy matching network. Case-4 monopoles fair no better for lengths from 10 to 50 degrees. However, the region from 60 through 90 degrees shows a much slower rate of resistance change from one step to the next. Unfortunately, this region also shows consistent capacitive reactance.

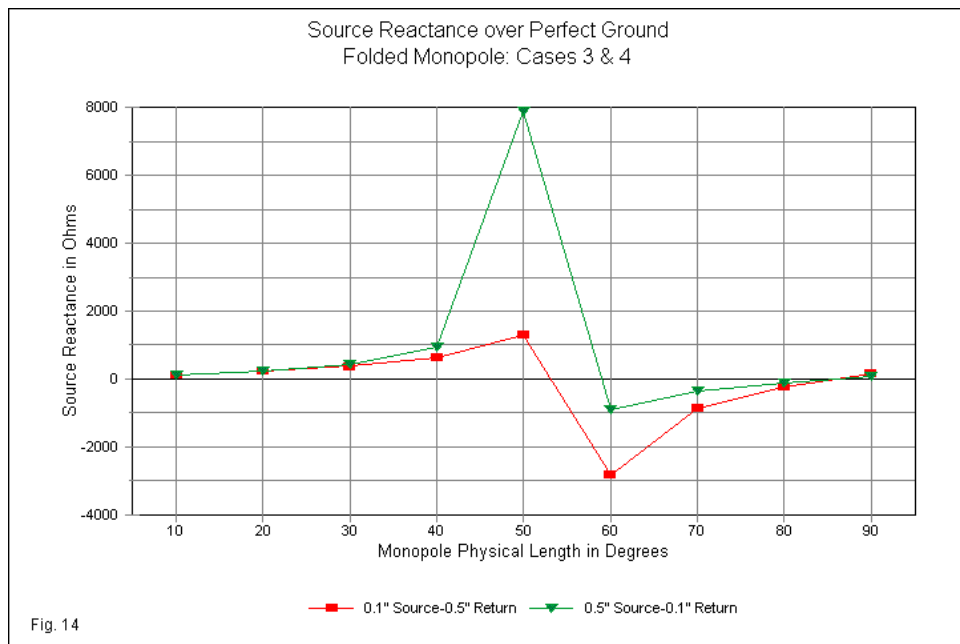

**Fig. 14** overlays the reactance curves for the two new cases. In general outline, the curves follow the pattern established by the first two cases that use equal-diameter legs. However, the transition regions call for some special attention. Cases 3 and 4 both show that the transition region occurs between lengths of 50 and 60 degrees. Within that 10-degree span, the two new structures differ considerably. By tracking the level of the 50- and the 60-degree peak values, we can obtain a fairly close approximation of the difference. For example, if we feed the thinner wire (Case 3), then the capacitive reactance at 60 degrees is close to  $-j3000$  Ohms, but

the inductive peak at 50 degrees is only a little over  $j1000$  Ohms. The zero-crossing point must therefore occur much closer to the 60-degree mark.

In contrast, in we feed the fatter wire (Case 4), the inductive reactance peaks at about  $j8000$  Ohms at the 50-degree level. By 60 degrees, the capacitive reactance is about  $-j1000$  Ohms. By the same reasoning, we must conclude that the zero-crossing point for this configuration is not much above 50-degrees physical length.

More generally, we see a widening of the possible range for reactance transitions and resistance peaks with these cases than when we simply change the diameter of equal-diameter versions of the folded monopole. A thin-fed wire to fat-return wire situation tends to push the transition point to a higher length level. In contrast, a fat-fed wire to a thin-return wire pushes the zero-crossing point to a lower total fold monopole height.

## Some Tentative Conclusions

Modeling demonstrations do not yield proofs of performance. However, from the general trends that we have observed with our four case studies, we may draw some conclusions that we may think of as reasonable expectations of folded monopole performance.

1. At very short lengths (up to 30 to 40 degrees), 2-wire folded monopoles of any description show very low source resistance values. The values are lower than we obtain with linear monopoles

of the same height. In fact, it is in this region that we find the closest coincidence between folded monopole and shorted transmission-line stub behavior with respect to the inductive reactance. When we translate the models to real types of wire, material losses alone are sufficient to create very high gain deficits. Below a total height of about 30 degrees, the losses may be high enough to jeopardize the utility of the structures for communications.

2. Between heights of 50 and 60 degrees, we find a transition region in which the resistance rises to a very high peak value. In the same region, the reactance peaks both inductively and capacitively, with a very small height region in which it crosses the zero point. The behavior closely resembles the behavior of centered linear horizontal antennas as they approach 1 wavelength or of linear monopoles as they approach  $1/2$  wavelength. In folded dipoles, the behavior occurs with lengths between 0.14 and 0.17 wavelength.

3. Although the region of peak values between 50 and 60 degrees dominates graphs of the folded monopole's feedpoint performance, the entire span from 40 to 70 degrees shows rapid changes in both resistance and reactance with only small changes in folded monopole height. These behaviors can make the matching of a folded monopole in this height region a very finicky task. In all cases, one must experimentally determine if the settings used will be stable through the entire set of environmental conditions that the antenna may face.

4. The most stable region of folded monopole performance occurs at physical lengths between about 70 and somewhere above 90 degrees. In virtually all cases, resonance will occur at physical heights between 80 and 85 degrees. Within the overall region, the resistance changes per unit of height change are relatively small. Reactance changes are likewise small and follow the normal progression from capacitive reactance below resonant length to inductive reactance above resonant length. Therefore, matching networks and wide-band impedance transformers will tend to show the same performance characteristics that they display when used with linear antennas.

5. For every resonant folded monopole, there is a linear monopole of some diameter that will resonate at the same length. The required diameter for the linear dipole is a mutual function of both the wire diameters and the wire spacing of the folded monopole. Since the equivalent linear monopole will be very large relative to the diameters of the wires within the folded monopole, it will exhibit far lower losses with real materials than the folded monopole using the same real materials, especially at very short lengths. However, the folded monopole may offer a considerable total weight reduction relative to the linear monopole, especially at longer, more stable overall heights.

In the tables, the numbers recorded are overly precise relative to the general reliability of the models with respect to reality. My reason for recording the reported modeling data in these terms was to ensure accurate graphing. At best, these notes serve as a general guide to reasonable expectations from folded monopoles.

By omitting real ground types and real materials from the calculations, the notes do not qualify as guides to building a physical antenna. Nonetheless, the consistency of the general trends may provide some insight into short folded monopole behavior.

In the cases that we have explored in this set of notes, both legs of the short folded monopoles used the same length, and the top wire shorted the upper end of the structure. However, short folded monopoles often find application where the return wire is longer than the fed wire. We have learned to name such applications, but it is less clear that we have developed any reasonable expectations of behavior. Therefore, we have another trail to explore through the forest of folded monopoles.

### **Appendix: A supplementary Exercise in Current Analysis**

The exercises that we have explored in developing some basic properties of folded monopole antennas focused upon antenna gain and the feedpoint impedance as guides. There is an alternative approach that may provide additional insights into the behavior of short and long folded monopoles. We may analyze the currents in the legs of the folded monopole into two component currents, often called radiation currents and transmission-line currents. At any point along the length of the folded monopole, the sum of the two current magnitudes and phase angles (one on each leg) result in the radiation current, while the difference yields the transmission-line current, assuming that we set up the model wires for the legs in parallel fashion, that is, counting from the ground up (or the top

down) for both legs. See the Antenna Modeling series of articles, #123, for details of how to set up the calculations. Although NEC output files list the currents in terms of both real and imaginary components and of magnitude and phase angle, EZNEC current tables list only the magnitude and phase angle. Thus, the first step is to convert the given values to real and imaginary components, then to perform the additions and subtractions, and finally to reconvert the values back into magnitudes and phase angles. A repetitive spreadsheet is, of course, the most convenient method for automating the required machinations.

If we perform the operation on a resonant folded monopole at 3.5 MHz, we obtain some interesting results. For the subject antenna using 0.1"-diameter elements and a separation of 1', the resonant length is 67.25 or 86.15 degrees. For comparison, let's also set up a resonant linear monopole of the same length. The linear monopole must have a diameter to 2.75" to be resonant at the prescribed physical length. For simplicity, we shall set both antennas against a perfect ground and use perfect (or zero-loss) conductors. NEC, of course, will provide a direct reading of currents on the linear monopole because it has no currents that we can analyze as transmission-line currents.

The results of the exercise appear in **Table 10**. On the left, the first four current magnitude and phase columns provide magnitude and phase-angle values from the EZNEC current table every 5 segments along the antenna's length from the ground upward. The next two columns provide the analyzed radiation current (Irad) magnitude and phase angle for each increment of antenna length.



The final two columns list the analyzed transmission-line current ( $I_t$ ) magnitude and phase angle. To the right are the current values for the linear monopole model.

Current Analysis of resonant Folded and Linear Monopoles for 3.5 MHz									Table 10		
Resonant Folded Monopole: 0.1" dia elements, 1' separation									67.25' (86.15 deg)		
Case/Seg	W1-Mag	W1-Ph	W2-Mag	W2-Ph	Irad-Mag	Irad-Ph	I <sub>t</sub> -Mag	I <sub>t</sub> -Ph	Resonant Segment	Monopole Magnitude	Phase
1	0.99999	0	1.00042	1.81	1.000	0.905	0.016	-89.875	1	1.000	0.000
5	0.99445	-2.01	0.994485	2.28	0.994	0.135	0.037	-89.892	5	0.994	-0.930
10	0.974986	-4.33	0.973425	3.19	0.972	-0.573	0.064	-89.872	10	0.973	-1.730
15	0.941564	-6.62	0.937667	4.32	0.935	-1.161	0.090	-89.909	15	0.936	-2.380
20	0.894696	-8.98	0.88769	5.69	0.884	-1.674	0.114	-89.896	20	0.885	-2.950
25	0.834915	-11.51	0.824455	7.38	0.818	-2.125	0.136	-89.895	25	0.820	-3.450
30	0.763205	-14.36	0.749087	9.51	0.740	-2.538	0.157	-89.896	30	0.742	-3.910
35	0.680709	-17.74	0.662969	12.32	0.649	-2.913	0.174	-89.895	35	0.651	-4.320
40	0.589072	-22	0.568023	16.19	0.547	-3.266	0.190	-89.897	40	0.549	-4.710
45	0.490552	-27.82	0.466948	21.94	0.434	-3.595	0.202	-89.897	45	0.436	-5.070
50	0.388915	-36.62	0.364471	31.31	0.312	-3.907	0.211	-89.897	50	0.314	-5.420
55	0.292285	-51.79	0.271422	48.45	0.181	-4.206	0.216	-89.899	55	0.181	-5.740
60	0.223735	-81.47	0.21853	81.47	0.033	-4.487	0.219	-89.899	60	0.027	-6.060

Except for the 60th segment, the radiation current magnitude values for both antennas are virtually identical. The slight aberration in the last value is a function of the folded monopole top connecting wire. Minimum current occurs at its center. As well, the pattern, although not the precise values, of radiation current phase is the same for both antennas. With respect to transmission-line currents on the folded monopole, the magnitude values increase from the ground toward the top. However, the phase angle of these currents is the same all along the antenna and 90 degrees out of phase with the feedpoint current. We would see similar results from a folded dipole counting from the feedpoint outward to the antenna end.

Next, let's examine a short folded monopole, perhaps one that is 20 degrees (15.612') long. We may not only perform a similar analysis (using each of the 12 segments in the model), but as well we may

again compare it with the corresponding 2.75"-diameter linear monopole of the same length. The results appear in **Table 11**.

Current Analysis of resonant Folded and Linear Monopoles for 3.5 MHz										Table 11		
20-Degree Folded Monopole: 0.1" dia elements, 1' separation 15.612'										20-Degree	Monopole, 2.75" dia.	
Case/Seg	W1-Mag	W1-Ph	W2-Mag	W2-Ph	Irad-Mag	Irad-Ph	Irl-Mag	Irl-Ph		Segment	Magnitude	Phase
1	0.99999	0	1.17153	180	0.086	-0.000	1.086	-0.000		1	1.000	0.000
2	1.01781	0	1.17316	180	0.078	-0.000	1.095	-0.000		2	0.895	-0.010
3	1.03577	0	1.17521	180	0.070	-0.000	1.105	-0.000		3	0.800	-0.020
4	1.05203	0	1.17691	180	0.062	-0.000	1.114	-0.000		4	0.715	-0.030
5	1.06709	0	1.17797	180	0.055	-0.000	1.123	-0.000		5	0.633	-0.040
6	1.08103	0	1.17818	180	0.049	-0.000	1.130	-0.000		6	0.554	-0.050
7	1.09389	0	1.17755	180	0.042	-0.000	1.136	-0.000		7	0.476	-0.060
8	1.10577	0	1.17599	180	0.035	-0.000	1.141	-0.000		8	0.398	-0.070
9	1.11673	0	1.17337	180	0.028	-0.000	1.145	-0.000		9	0.320	-0.080
10	1.12677	-0.01	1.16977	180	0.022	0.262	1.148	-0.005		10	0.240	-0.090
11	1.13604	-0.01	1.16496	180	0.014	0.393	1.150	-0.005		11	0.158	-0.100
12	1.14474	-0.01	1.15881	180	0.007	0.814	1.152	-0.005		12	0.066	-0.110

The linear monopole on the right displays a normal progression of currents from the ground upward, despite the very short length of the antenna. However, the folded monopole shows something entirely different, due to the fact that the overall length falls well below the critical region (between 40- and 60-degree lengths) in which the antenna transitions from transmission-line-like behavior to antenna-like behavior. (See **Fig. 6**, which shows the reactance of a comparable transmission line, a folded monopole and a linear monopole to see more vividly the critical transition length region.) At the very short length of 20 degrees, the folded monopole shows far higher current magnitude in the transmission-line column than in the radiation column. Because the two wires, treated as a transmission line, are almost perfectly out of phase with each other, the net phase angle is zero and constant along the short length. The minuscule radiation current magnitude is accompanied by a minimal phase-angle shift that only becomes apparent at the top of the folded monopole.

Applying the current analysis to the modeled current values for the short folded monopole yields an impression that the short folded monopole is likely to be a relatively poor radiator. In some applications, it might actually be superior to the short linear monopole once we add to the single element the requisite loading coil at a plausible level of  $Q$ . Nevertheless, below the critical transition length region, the short folded monopole principally acts like a shorted transmission line rather than like an antenna.

## Chapter 33: Short Folded Monopoles - Extended Applications

In Chapter 31, About the Folded Monopole, we briefly explored the use of a folded monopole that was self-resonant but which also used a linear extension. The result, as expected, involved an increase in both the resistance and the inductive reactance at the source or feedpoint. The folded monopole continued its normal antenna function in terms of radiation, with a small increase in gain due to the increased overall length.

In Chapter 32 of this 2-part examination of short folded monopoles, we explored the properties of complete antennas, that is, folded monopoles that used equal-length legs. We saw a progression of properties from physical lengths of 10 through 90 degrees. The progression may have held some surprises for those not used to folded monopole behavior. At very short lengths (up to 30 degrees or so), the source resistance was very low, lower than for an equivalent linear monopole. In the 50- to 60-degree region, the source resistance became very high, with an accompanying set of peaks for inductive and capacitive reactance--and a narrow zero-crossing length between them. Only as the folded monopole exceeded about 70 degrees did the source impedance curves return to behaviors that we associated with linear monopoles adjusted for the impedance transformation that is inherent to the folded structure.

In this item, we shall combine the two ideas into a single exploration. We shall look at short folded monopoles from 10

through 90 degrees with linear extensions. One goal will be to see what patterns of antenna performance emerge from the exercises.

One might well wonder whether the exercise might be simply the satisfaction of idle curiosity. We do not normally hear of extended short folded monopoles among the many classes of antennas used by amateur or commercial interests. Just as a rose by any other name would smell as sweet, so an antenna by any other name would radiate just as well. There are a number of structures composed of extended short folded monopoles that we have managed to re-name--and sometimes, to misunderstand as a result of the different name. In the vagaries of labels lie many roads to misconception.

Fig. 1

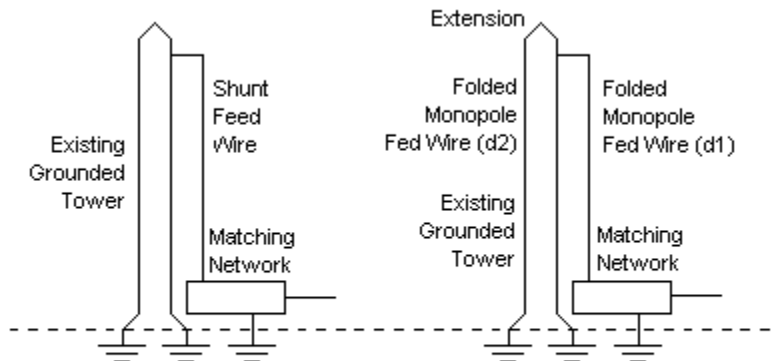

Two Ways of Looking at Low-Band Radiator  
Using an Existing Grounded Tower

Consider the left-hand side of **Fig. 1**. The sketch shows a grounded tower fed for one of the lower amateur bands by what we call a shunt feed system. We connect a wire parallel to the tower. The top end connects to the tower so that the wire length combined with its distance from the tower allow--so we usually say--coupling to the tower. We strive for a length that will yield a feedpoint impedance we can easily match to coaxial cable using the simplest network for lowest losses. The wire length usually emerges from experience, and AWG #12 is popular for the purpose. One instruction set that I read suggests that if the feedpoint impedance is not within a desirable range, we should change the spacing from the tower until the impedance is acceptable.

On the right in **Fig. 1**, we have a short folded monopole that places its top wire at a height which is not the full length of the return wire. The return wire happens to be a tower structure that is very wide. Hence, we obtain a very sizable step-up in impedance relative to a linear wire of the same length. Since the tower goes on above the folded monopole, we anticipate that the feedpoint impedance will show an increase, if we assume that the folded monopole portion is self resonant. If the folded monopole section is shorter than resonant, then our work so far leaves the impedance unknown. So the sketch has added a network at the feedpoint in case we need it to effect a match with the main feedline.

The perspective that we took in the right portion of the sketch makes clear that the fed wire is as much a part of the radiating structure as the tower. Its function is not simply to couple energy to the tower. Rather, its function is to form with the tower a single

radiating element. The 2-wire portion of the structure effects an impedance transformation relative to the tower alone--if base fed--but the radiating currents are a joint function of both wires. Of course, between the left and right sides of **Fig. 1**, we find no difference in the structure outline. The only differences appear in the labels for the structure's parts.

Fig. 2

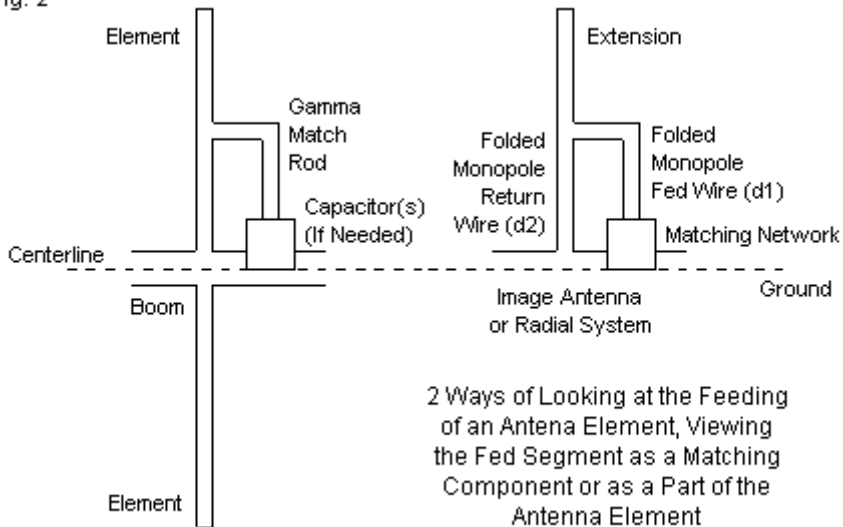

The left part of **Fig. 2** shows a generalized sketch of a gamma matched element. The most common occurrence of the match these days is for the driven elements of Yagi parasitic arrays in which we wish to connect all elements to the boom. Ordinarily, the

impedance of the element without the gamma match is lower than the desired value, usually a value well below the 50-Ohm impedance of standard coaxial cable. We call the portion of the gamma match that parallels part of the element length the gamma rod. We short the end to the element in a position that yields the desired impedance at the new feedpoint. By a judicious selection of rod diameter, rod spacing from the element, and rod length to the connection, we can sometimes produce a purely resistive 50-Ohm impedance. If there is a reactance, we strive to make it inductive so that a simple series capacitor will compensate. Note that we normally consider the gamma rod to be a part of a matching network and not part of the radiating element.

However, if we redraw the upper half of the sketch and terminate it at ground (instead of at a grounded boom), we obtain the sketch on the right of **Fig. 2**. In this case, the fed wire or rod becomes one wire of a 2-wire folded monopole, with an extension beyond the folded structure limit. The ground forms--if we wish to think in these terms--an image of the upward or physical portion of the antenna. The gamma match turns out to be a short folded monopole with an extension. As such, both wires in the folded structure make up the radiating element until we reach the extension. From our work with full folded monopoles and their linear equivalents, we know that the equivalent diameter of the folded portion of the antenna is much larger than the diameter of the extension along. Hence, every gamma-matched element contains at least a small imbalance. The related Tee match overcomes the imbalance by using a folded monopole on each side of the boom.



As a consequence of these instances of short folded monopole applications--whatever the preferred labels--the behavior of short folded monopoles with extensions becomes more than an idle exercise. It holds some possibility of improving our understanding of certain structures that combine impedance transformation and radiation. As well, we might develop some techniques that would be applicable to real antenna planning exercises.

Our basic work will follow the pattern on the first episode. We shall place the folded monopoles over perfect ground and use lossless wire in order to eliminate some complex variables. In a real planning situation, we would put into our models the material conductivity of the proposed wire and the best estimate of real ground conditions. As well, our models would include the actual radial system beneath the folded monopole.

Since we need some usable increment between modeled structures, we shall again use the physical height of the structures in degrees, where 360 degrees is 1 wavelength. We shall explore structures in 10-degree increments at 3.5 MHz. **Table 1** provides a convenient correlation between the degree markers and the equivalent height in feet at the test frequency. At 3.5 MHz, a wavelength is about 281.02'.

Physical Heights of Electrical Lengths at 3.5 MHz.	
1 wl = 281.02'	
Degrees	Feet
10	7.806
20	15.612
30	23.418
40	31.234
50	39.031
60	46.836
70	54.643
80	62.449
90	70.255
Table 1	

We shall create models using an implementation of MININEC 3.13. The program that I am using is Antenna Model, which incorporates a considerable number of correctives to overcome some MININEC shortcomings. Since all of our models will use different diameters for the fed and the return wires, NEC (-2 or -4) will not yield results that pass Average Gain Test (AGT) muster. As we shall eventually see, even MININEC's more ready handling of junctions between wires having dissimilar diameters has limits. However, we shall be able to create some usable models within those limits. If you try to replicate the models using a different implementation of MININEC, expect to find some variance in the output reports. If the implementation does not include an accessible AGT score, you may simply have to guess at the reliability of the model that you create.

The project itself is simple, although long and occasionally tedious. **Fig. 3** shows its general outlines. I shall create a series of short folded monopoles for each test case. Since the most common cases of short folded monopole applications involve return wires that are fatter than the fed wire, the models will all follow this pattern. The folded monopoles will appear in 10-degree steps, from 10 through 90 degrees. To each folded monopole that is shorter than 90 degrees, I shall attach to the return wire--using the same wire diameter as the return wire--a series of extensions in 10-degree steps. Each series will progress until the total element length is 90 degrees.

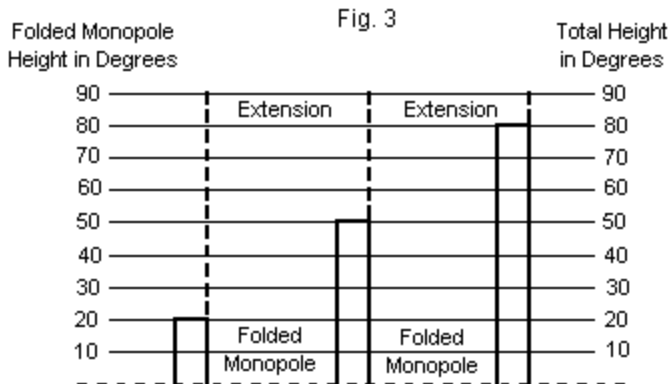

Unfolding Short Folded Monopole and Extension Behavior

Obviously, one might carry the progressions of folded monopoles beyond 90 degrees or the extensions beyond 90 degrees. However, my goal is not to replicate every possible structure we might use. Rather, it is only to elicit the patterns of behavior of the resulting antennas, with special attention to the feedpoint impedance. We would have to end somewhere, and there is little point in becoming totally lost in a morass of excessive data. Indeed, the data that we shall observe is complex enough for one episode.

### Case 1: $D_1 = 0.1"$ , $D_2 = 0.5"$ , Space = 12", 2 Wires

Our study cases can begin with a structure that we examined in the first episode. It consists of two wires spaced 12" apart. The fed wire will be 0.1", corresponding to AWG #10 wire that is midway between the wires used in amateur and commercial practice. The

return wire is 0.5" in diameter to give us a sense of standard 2-wire shunt feeding of an existing mast. I have selected this starting point because the AGT scores are generally very good to excellent within MININEC despite the difference in element diameter. At a resonant length of 67.08', the reported source resistance is about 209 Ohms, compared to a calculated value of 210 Ohms.

In the present context, we shall look at short monopoles in 10-degree increments. To each of these folded monopoles, we shall add a 0.5" diameter extension in 10-degree increments. The minimum length for each portion of the following data will be the height of the simple folded monopole. However, every folded monopole will end up with a height of 90 degrees. When we later speak of the data, we may use expressions such as "20-50" to designate a line from the table. The first number indicates the height of the folded monopole portion of the antenna, while the second number reports the total height that includes the extension, if any.

The data includes a report of the AGT, the source resistance and the source reactance. In addition, there are entries for the reported gain broadside to the pair of wire and edgewise to the wires. In the latter case, the maximum gain value appears as a measure of the pattern's circularity or ellipticalness. **Table 2** records the data for the present 2-wire case.

Case 1	Fed Wire	Rtn Wire	Space	Freq MHz	Table 2	
2-Wire	0.1"	0.5"	12"	3.5		
Fld Ht	Ttl Ht	Res	React	BS Gn	Edge Gn	AGT
10	10	0.001	100.95	2.54	2.54	0.994
	20	0.003	101.86	3.90	4.79	0.997
	30	0.014	102.97	4.59	4.82	0.998
	40	0.05	104.48	4.77	4.86	0.999
	50	0.15	104.48	4.86	4.90	0.999
	60	0.46	106.88	4.93	4.96	0.999
	70	1.79	111.59	5.00	5.03	0.999
	80	12.46	123.91	5.08	5.11	0.999
	90	32.00	80.12	5.18	5.21	1.000
20	20	0.026	215.81	4.24	4.79	0.998
	30	0.079	219.68	4.63	4.82	0.998
	40	0.25	224.77	4.78	4.85	0.999
	50	0.74	231.83	4.86	4.90	0.999
	60	2.31	243.14	4.93	4.96	0.999
	70	9.05	265.91	5.00	5.03	0.999
	80	67.24	325.48	5.08	5.11	0.999
	90	127.76	114.37	5.17	5.21	1.000
	30	30	0.329	370.00	4.69	4.82
40		0.87	384.32	4.79	4.85	0.999
50		2.52	405.29	4.86	4.90	0.999
60		7.99	440.35	4.92	4.95	0.999
70		33.45	515.42	4.99	5.02	0.999
80		305.55	695.01	5.08	5.10	0.999
90		243.76	71.18	5.17	5.20	1.000

40	40	3.26	628.09	4.81	4.86	1.000
	50	8.78	685.39	4.86	4.90	0.999
	60	29.75	794.04	4.92	4.95	0.999
	70	157.54	1066.13	4.99	5.02	0.999
	80	1618.84	663.93	5.07	5.10	0.999
50	90	290.05	-18.05	5.16	5.19	1.000
	50	44.30	1308.13	4.88	4.91	1.000
	60	186.03	1771.43	4.93	4.95	0.999
	70	2465.20	3029.80	4.99	5.03	0.999
	80	938.60	-822.33	5.06	5.09	0.999
60	90	266.37	-65.88	5.16	5.19	1.000
	60	11300.00	-2827.45	4.94	4.97	1.000
	70	1007.64	-1932.27	4.99	5.02	0.999
	80	378.72	-582.47	5.06	5.09	1.000
	90	231.60	-56.86	5.15	5.18	1.000
70	70	282.91	-882.63	5.01	5.04	1.000
	80	235.25	-380.81	5.07	5.10	1.000
	90	211.97	-14.02	5.15	5.18	1.000
80	80	191.25	-223.78	5.09	5.12	1.000
	90	212.89	48.85	5.16	5.19	1.000
Notes:	Fld Ht = Height in electrical degrees of folded monopole section					
	Ttl Ht = Overall height in electrical degrees of folded monopole					
	and extension of return wire					
	Res = Source resistance in Ohms					
	React = Source reactance in Ohms					
	BS Gn = Gain in dBi broadside to the wires					
	Edge Gn = Maximum gain in dBi in line with wires					
	AGT = Average Gain Test score relative to 1.000					

Except for the shortest lengths of both the folded monopole and the extension, the AGT scores are excellent. Therefore, the table makes no adjustments to the reported values. The gain values

generally accord with those for folded monopoles that form the complete structure of the entire length. In the last episode, we noted the losses that accompany relatively short structures when we translate our perfect wire into real materials. In practical terms, there is very little difference in the numerical performance and virtually no operational real difference in gain performance among any of the various structures when the total height exceeds perhaps 60 degrees or so.

The impedance progressions that follow on each folded starting point exhibit interesting patterns. We may use the 10-10 through 10-90 series as a sample. The reactance increases very slowly but steadily. However, as it crosses the resonant region (between 80 and 90 degrees total height), we do not find resonance. Instead, we find a reversal of the direction of change of reactance. The resistance for all total length up to 80 degrees is too low to be useful. However, the rate of increase climbs so that with a 90-degree total height, we achieve a matchable pair of resistance and reactance values. If we track the 20-n and the 30-n series of models, we find the same pattern for both the resistance and the reactance, with an adjustment for a new starting value set that emerges from the new length of the folded section.

Above a folded length of 40 degrees the pattern appears to change. We seem to find more rapidly changing resistance and reactance values. However, we are entering the region in which a full folded monopole would experience rapidly changing impedance values. The extension portion of each structure has the effect of increasing the folded monopole length by a small amount with each step.

Small changes of total length yield large changes in resistance and reactance. Between 40-80 and 40-90, we see a reversal in the inductance, suggesting a narrow resonant region. For the 50-degree folded structure, total height between 70 and 80 degrees records a similar reactance zero crossing. When the folded structure is over 60 degrees high, the antenna begins past the cross-over point and shows predominantly capacitive reactance. However, the 80-90 case yields another matchable impedance combination.

One of the oddities of matching practices that uses short folded monopole structures is the variability of practice. Gamma matches for Yagi elements tend to use the shortest practical folded section that will effect the desired impedance transformation. In contrast, tower shunt feeding tends to use the longer folded structure that will get the job done. See Chapter 6 of *The ARRL Antenna Book*, 20th Edition, and Chapter 9 of ON4UN's *Low-Band DXing*, 2nd Edition, for samples of tower shunt feeding. Gamma and related matching systems appear in Chapter 23 of the ARRL book. In fact, neither Yagi practice nor tower practice seems to take note of the other way of achieving the same goal.

Although our case study is not itself very realistic relative to either HF Yagis or to MF/HF towers, we may use it as a way to explore a technique for surveying a more complete range of options when using short folded structures to effect impedance matching. We can create graphs of the impedance reports. **Fig. 4** handles the reported resistance values for our sample. The X-axis records the



total height of the structure, while the individual lines represent different heights for the folded portion of the antenna.

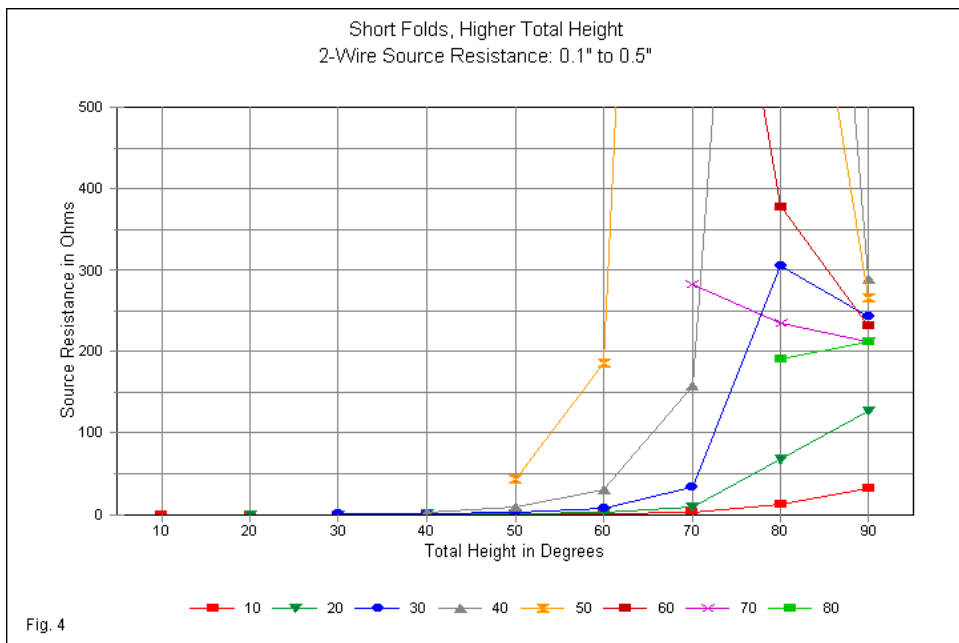

I have cut off the Y-axis for multiple reasons. I arbitrarily set a 500-Ohm limit to the upper end of the resistance range. The decision in any real case would rest on an estimate of the highest resistance value that might be acceptable. The range should be great enough to show the rate of resistance change from one step to the next. However, it should not be so high as to obscure how close to an ideal value of resistance the modeled value comes. In this case, we

might be concerned with 50 Ohms as a target value. **Fig. 5** shows a similar treatment for the reported reactance values.

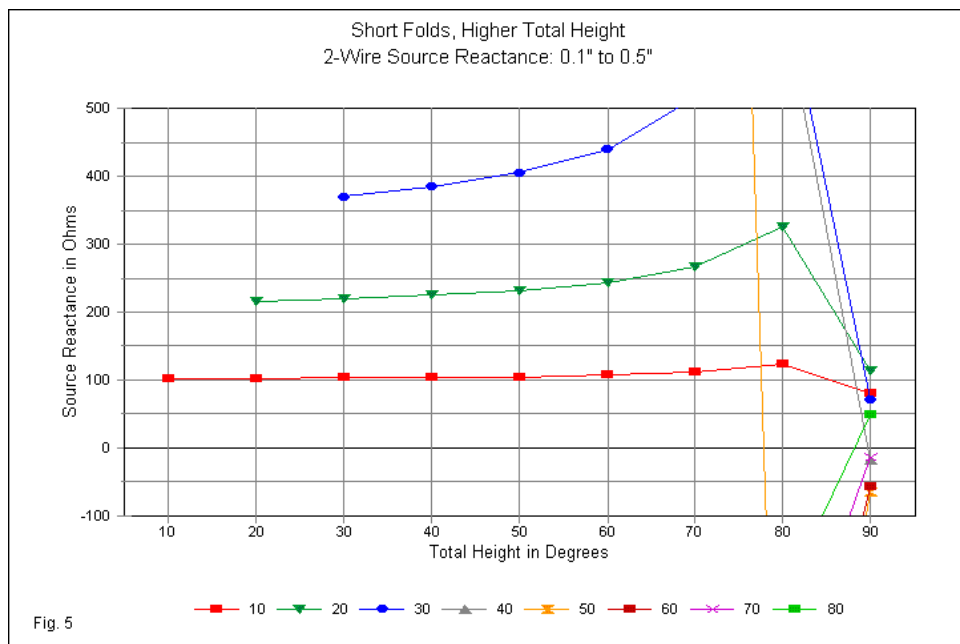

The reactance values included in the graph range from  $-j100$  Ohms to  $+j500$  Ohms. Most short monopole impedance transformation systems seek an inductive reactance (or zero reactance) at the feedpoint to allow matching with only high-Q capacitors. The selected range lets us see both the recorded reactances at the sampling points and the relevant rates of change to the adjacent sampling points.

The combination of the two graphs allows us to select candidates for implementation. In most cases, we shall find few viable candidates, since we are likely to be working with an existing grounded mast or tower. However, in the exercise, we are free to note any viable combinations. In the present case, the resistance table offers a number of combinations that show (by the graph's definition) usable values with modest rates of change in resistance to the next sampling point. However, the reactance graph reduces the number of candidates. Within the constraints of the exercise, total height values between 80 and 90 degrees combined with folded heights between 10 and 20 degrees offer useable combinations with relatively low rates of change. The longer folded structures that showed promise in terms of their resistance reports in this region tend to disqualify themselves due to the high rate of reactance change between sampling point. Any network that we might use to produce a final resistive impedance of 50 Ohms would likely have at best a very narrow bandwidth.

Our accumulation and exploration of data shows us how we can use the information as the basis for planning installations. However, the structure that we used is relatively unrealistic. It appears because the models are highly reliable as measured by the AGT values (which are a necessary but not sufficient condition of model adequacy). Perhaps a more realistic scenario might be useful as a second exercise.

**Case 2: D1 = 0.1", D2 = 8.8", Space = 36", 2 Wires**

Real towers that we might use as a shunt-fed vertical antenna vary in face size. We may use a modest tower with a 12" face dimension. For simplicity in the models, we may use the standard AM BC equivalence and multiple the face by 0.74 to obtain an 8.8" diameter wire that approximates the tower. (An actual planning session should model the tower structure as exactly as possible.) This new diameter forms the return wire for the folded structure and the extension above and beyond the folded structure. We may retain the 0.1" diameter fed wire as a realistic value.

The next step is to determine a workable space between the wires of the folded section. Despite MININEC's superiority in handling junctions of wires having different diameters, it will show limits to its reliability. We not only have a radical difference in wire diameters, but as well, we have two wires that are fairly closely spaced. I sampled variety of spacing values and return-wire diameters using a 30-degree folded structure and an 80-degree total height to see what AGT scores might emerge. The results appear in **Table 3**.

MININEC (Antenna Model) AGT Values				
Fed and Top Wires: 0.1" diameter				
Folded Monopole: 30 Deg; Ttl Ht: 80 Deg				
Return	Average Gain Test vs. Spacing			
Diameter	12"	24"	36"	
1	0.999	0.999	0.999	
2	0.998	0.999	0.999	
3	0.995	0.999	0.999	
4	0.992	0.998	0.999	
5	0.986	0.997	0.998	
6	0.978	0.995	0.998	
7	0.968	0.994	0.997	
8	0.955	0.992	0.996	
9	0.940	0.989	0.995	
10	0.921	0.986	0.994	
Table 3				

For any set spacing, the AGT values degrade as we increase the diameter of the return and extension wires. In some circles, AGT's are considered excellent if they fall between 0.995 and 1.005. They are usable between 0.990 and 1.010. Beyond this latter range, the data becomes questionable. Even within the usable range, we should adjust the data by virtue of the AGT score if we are developing (meaningful and comparative) progressions of values, especially if the AGT value changes from one sample to the next. For the projected diameter of the return and extension wires in the models that we shall run, the minimum spacing for adequate AGT scores is 36" or 3'. This value tends to coincide with commercial practice for folded assemblies, so I shall use it in amassing a data collection.

AGT scores will tend to improve for longer structures and degrade for shorter total antenna heights. Therefore, we should adjust the reported values to arrive at the best approximation of a final value. Because we are dealing with a folded structure, we must reverse the normal procedure set. Ordinarily, we convert the AGT score into a "dB' value ( $=10 \log \text{AGT}$ ) and subtract it from the reported gain. (An AGT less than 1 results in a negative dB value, which increases the reported gain when we do the subtraction.) Experience with the full folded monopoles in previous studies suggests that we must add the AGT-dB to the reported value to obtain gain values that are reasonable in terms of their consistency with values that emerge from models showing an ideal or very-nearly ideal AGT value. We normally adjust impedance values by multiplying the reported number by the AGT itself. However, folded structures appear to require that we divide the report by the AGT in

order to obtain values that coincide with calculated impedance transformations.

With these cautions and conditions, we may proceed to model our ersatz tower and its shunt wire as a series of 2-wire short folded monopoles and extensions. We shall use the same increments that we used for the initial case. **Table 4** shows the amassed adjusted data. However, we must add one more reservation. The standard impedance transformation equation for resonant folded dipoles results in an impedance of about 614 Ohms. The resonant version of our new model is 65.286' high and reports an adjust resistance of 574 Ohms. The difference is about 7%. We cannot be truly definitive in assigning a source to the difference. However, the end wire is now 3' long, almost 5% of the total folded monopole height. As well, the impedance ratio is about 17:1, a very large ratio indeed.

Case 2	Fed Wire	Rtn Wire	Space	Freq MHz	Table 4	
2-Wire	0.1"	8.8"	36"	3.5		
Fld Ht	Ttl Ht	AGT	Res	React	BS Gn	Edge Gn
10	10	0.997	0.0066	111.10	4.20	4.20
	20	0.994	0.0099	111.87	2.46	2.46
	30	0.993	0.022	112.50	3.30	4.83
	40	0.993	0.057	113.05	4.27	4.89
	50	0.994	0.16	113.78	4.64	4.95
	60	0.995	0.50	115.05	4.84	5.03
	70	0.995	1.96	117.58	4.95	5.12
	80	0.996	11.09	119.58	5.05	5.21
	90	0.996	9.46	104.97	5.16	5.32
20	20	0.993	0.053	219.45	1.77	1.77
	30	0.993	0.109	221.61	3.46	4.82
	40	0.993	0.276	224.14	4.30	4.88
	50	0.994	0.763	227.81	4.65	4.94
	60	0.995	2.35	233.80	4.84	5.03
	70	0.995	9.31	245.60	4.95	5.11
	80	0.996	52.49	253.02	5.05	5.21
	90	0.996	40.80	188.05	5.16	5.32
	30	30	0.993	0.367	356.07	3.73
40		0.993	0.851	362.75	4.35	4.87
50		0.994	2.30	373.03	4.66	4.94
60		0.995	7.09	390.30	4.84	5.02
70		0.995	28.87	424.55	4.95	5.11
80		0.996	160.90	429.21	5.05	5.20
	90	0.996	99.28	262.46	5.15	5.31

40	40	0.994	2.565	556.86	4.44	4.87
	50	0.994	6.42	581.11	4.69	4.94
	60	0.995	20.18	625.83	4.84	5.02
	70	0.995	88.67	717.12	4.95	5.10
	80	0.996	446.64	614.14	5.05	5.20
	90	0.996	185.05	318.48	5.15	5.31
50	50	0.995	21.47	942.78	4.73	4.95
	60	0.995	67.57	1064.06	4.85	5.02
	70	0.995	357.19	1324.15	4.95	5.10
	80	0.996	974.68	473.54	5.05	5.20
	90	0.996	286.25	346.36	5.15	5.30
60	60	0.995	441.99	2357.24	4.87	5.03
	70	0.995	2770.43	2148.50	4.96	5.10
	80	0.996	1048.28	-103.48	5.05	5.19
	90	0.996	385.36	350.59	5.14	5.30
70	70	0.996	1612.69	-1621.38	4.97	5.12
	80	0.996	752.04	-310.59	5.05	5.20
	90	0.996	480.22	349.15	5.14	5.30
80	80	0.996	570.75	-244.57	5.07	5.21
	90	0.996	593.94	354.65	5.15	5.30
90	90	0.996	794.83	382.98	5.16	5.32
Res	65.286'	0.996	576.81	-0.07	5.10	5.25
Notes:	Fld Ht = Height in electrical degrees of folded monopole section					
	Ttl Ht = Overall height in electrical degrees of folded monopole					
	and extension of return wire					
	AGT = Average Gain Test score relative to 1.000					
	Res = Source resistance in Ohms					
	React = Source reactance in Ohms					
	BS Gn = Gain in dBi broadside to the wires					
	Edge Gn = Maximum gain in dBi in line with wires					
	Res = Resonant folded monopole using the prescribed wire					
	diameters and spacing					



Within the limits of our case study, the gain values are completely normal (with the usual reservations about the very shortest folded and total height values). Broadside gain values at a total height of height of 90 degrees coincide very closely with corresponding values for the smaller and narrower model of Case 1. The edgewise gain values provide a measure of the degree to which the 2-wire structure ovalizes the pattern.

The significant differences between the values in **Table 4** vs. those in **Table 2** appear in the resistance and reactance columns. Between the two tables, we note a large difference in both the return/extension wire diameter and the spacing between wires. Therefore, we shall expect to see differences in the impedance values for each increment of folded structure.

Between folded structures heights of 10 and 30 degrees, perhaps the biggest surprise may be that we see the same general pattern of values that we experienced with Case 1. The resistance values for Case 2 are consistently about 1/3 the level of those for Case 1. However, the reactance values for each increase in the return wire length are comparable between the two cases. The parallel extends even to the decrease in inductive reactance that occurs in the total height interval between 80 and 90 degrees. The amount of decrease for the 8.8" example is somewhat less than for the 0.5" return wire, but it is equally distinct.

As we increase the height of the folded structure, the parallels remain, but with reservations. For the narrower structure, the reactance zero-crossing first appeared with a folded structure that

was 40 degrees high. With our more widely spaced model, the folded structure reaches 60 degrees before we encounter the first zero crossing. If the total height for Case 2 is 90 degrees, we find nearly identical inductive reactance values for folded heights between 50 and 90 degrees. The shorter the folded structure within this range, the lower the resistance value.

The general trends give us a picture of both consistency with the earlier models and of adjustment for the new values of return/extension wire diameter and spacing. In order to translate those general trends into a more adequate planning venue, we may graph both the resistance and the reactance values. Since we do not have a real tower around which to plan, we may use that same limits applied to the graphs for the earlier case. **Fig. 6** shows the relevant resistance values.

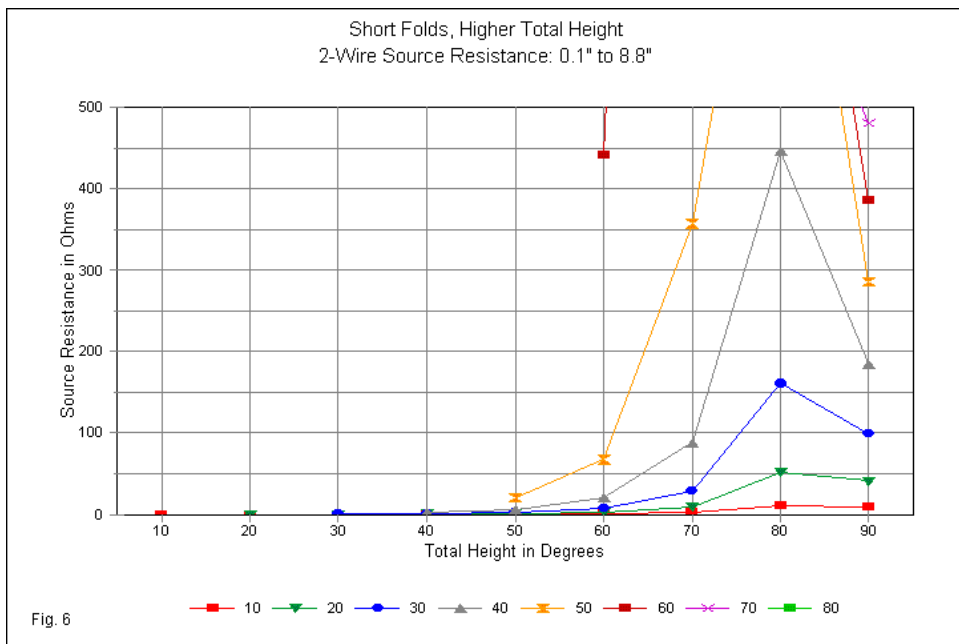

With respect to resistance, the 20- and 30-degree folded structures show perhaps the most promise when used with total heights between 80 and 90 degrees. Especially notable is the relatively slow rate of change in resistance with changes in height over this region. These conditions suggest that variables in the physical structure relative to the model will be manageable in terms of field adjustments toward the final antenna.

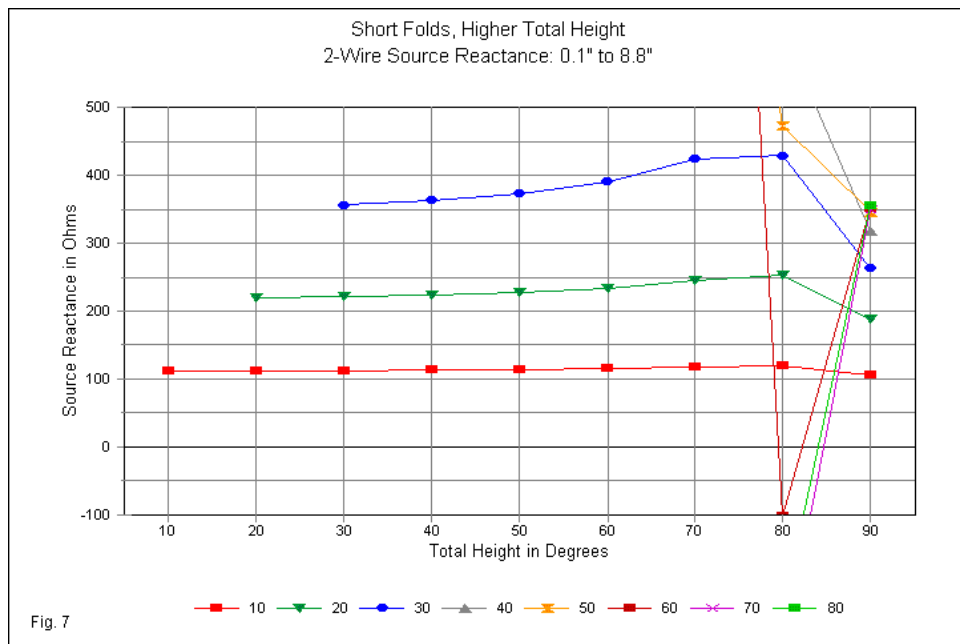

**Fig. 7** shows the corresponding reactance graph. It tends to confirm the initial judgment of the promise offered by the 20- and 30-degree folded structures with higher extensions. With the shorter folded structures, the inductive reactance increases with the length of the folded monopole for any given total height. However, it remains manageable. Long folded structures might yield workable values of inductive reactance at a total height of 90 degrees, but the rate of change between 80 and 90 degrees total height is very steep.

We may note in passing that the resistance curves for all lengths of folded structure show a downward trend between 80 and 90 degrees. Although we are working with a simple straight tower (equivalence) in these models, it is fairly easy for typical amateur towers to exceed 90 degrees in electrical length without passing the 70' mark of our 90-degree tower. Most shunt-fed amateur towers hold one or more Yagi antennas at the top. These structures tend to form rudimentary and imperfect top hats that increase the effective electrical length of the tower considerably. Hence, a 90-degree physical tower may easily become 100 or 110 degrees electrically. The consequences lie outside the limits set on this exercise, but we can expect to find lower resistances and variations in the reactance. If the tower is too tall electrically, we may easily find a shift back into capacitive reactance. Within modest electrical height increases relative to the study limits, we need to study all potential folded structure heights (or shunt lengths). The longest folded structures in conjunction with the longest total heights tend to show very high rates of change in resistance and reactance with small changes in total height. The result is normally a very narrow operating bandwidth for any given set of matching components.

### **Case 3: D1 = 0.1", D2 = 8.8", Space = 36", 3 Wires**

One possibility, rarely explored by amateur installations but regularly used commercially, is to provide multiple fed wires. **Fig. 8** shows the configurations that we have and shall explore here. Both of our earlier sample cases used 2-wire construction. However, 3-, 4-, and 5-wire construction is feasible, assuming that it might

increase the number of options available for shunt feeding a tower or other applications of folded monopole structures.

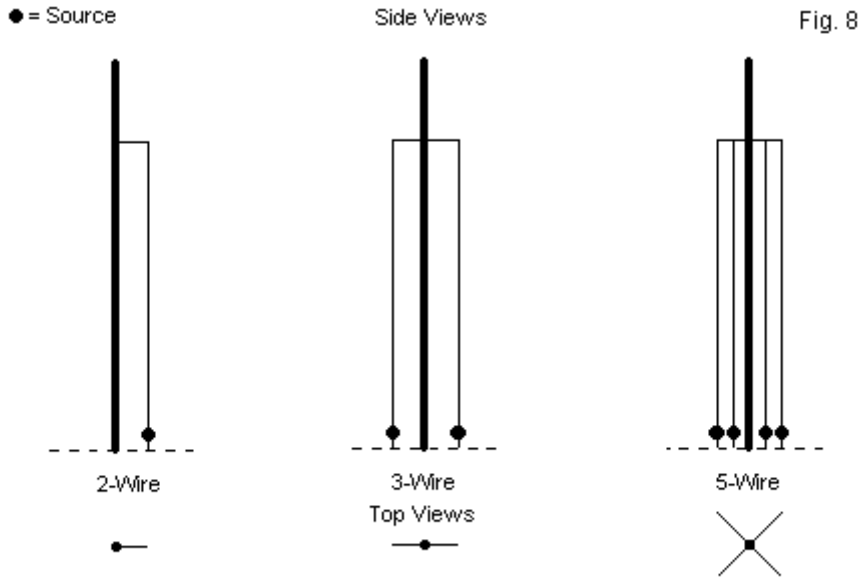

Some Alternatives to the Simple "Shunt" Feed

In these notes, we shall take up just two of the added options: 3-wire and 5-wire configurations. The 3-wire models will use a pair of 0.1" diameter fed wires on opposite sides of the central 8.8" tower-equivalent return wire and extension. To ensure reasonable AGT values, we shall retain the 36" spacing between the fed wires and the return wire. All of the procedures for adjusting values according to the AGT scores will also apply to this case. The only modeling

difference lies in the need for having 2 sources which are, in effect, in parallel relative to the overall structure. If we bring these sources together, the composite source impedance will be composed of resistive and reactive components that are each half the value of the values for the individual fed wires.

The data for the 3-wire assemblies appear in **Table 5**. Although the simple folded monopoles in the earlier study ("What is a Folded Monopole") all produced circular azimuth patterns at resonant lengths, we find elongated edgewise patterns in these models, likely due to the very large diameter difference between the fed wires and the return wire. However, as we increase the total height of the antenna to 80 degrees for any height of folded structure, the azimuth pattern becomes circular. The more symmetrical structure of the 3-wire models also shows a slight improvement in AGT values relative to the 2 wire models.

Case 3	Fed Wires	Rtn Wire	Space	Freq MHz		Table 5	
3-Wire	0.1"	8.8"	36"	3.5			
Fld Ht	Ttl Ht	AGT	Res	React	BS Gn	Edge Gn	
10	10	0.976	0.001	63.15	4.21	4.89	
	20	0.985	0.004	62.98	4.48	4.82	
	30	0.990	0.017	63.17	4.64	4.81	
	40	0.994	0.053	63.53	4.73	4.83	
	50	0.995	0.158	64.32	4.81	4.87	
	60	0.995	0.501	65.64	4.89	4.92	
	70	0.996	1.99	68.24	4.97	4.98	
	80	0.996	11.28	70.23	5.06	5.06	
	90	0.996	9.46	55.54	5.16	5.16	
20	20	0.987	0.036	128.47	4.55	4.80	
	30	0.991	0.096	130.04	4.65	4.80	
	40	0.993	0.28	132.58	4.73	4.82	
	50	0.995	0.81	136.29	4.81	4.86	
	60	0.995	2.54	142.73	4.88	4.91	
	70	0.996	10.23	155.38	4.96	4.98	
	80	0.996	57.52	160.82	5.05	5.06	
	90	0.996	40.44	94.65	5.16	5.16	
	30	30	0.992	0.43	217.68	4.68	4.80
40		0.993	1.01	224.66	4.74	4.82	
50		0.994	2.80	236.35	4.80	4.85	
60		0.995	8.87	256.60	4.88	4.91	
70		0.995	38.17	297.52	4.96	4.97	
80		0.996	200.16	267.25	5.05	5.05	
90		0.996	92.01	114.18	5.15	5.15	
40		40	0.994	4.07	371.40	4.76	4.82
		50	0.994	9.99	402.19	4.81	4.85
	60	0.995	33.80	465.61	4.88	4.90	
	70	0.995	177.37	594.91	4.96	4.97	
	80	0.996	493.07	177.87	5.04	5.05	
	90	0.996	146.19	104.80	5.15	5.15	



50	50	0.995	58.61	804.10	4.84	4.87
	60	0.995	228.00	1059.74	4.89	4.91
	70	0.995	1444.16	749.78	4.96	4.96
	80	0.996	462.18	-134.78	5.04	5.04
	90	0.996	178.60	79.46	5.14	5.14
60	60	0.995	2562.46	-1476.48	4.91	4.92
	70	0.995	641.04	-696.82	4.96	4.97
	80	0.996	292.98	-182.94	5.04	5.04
	90	0.996	189.41	63.58	5.14	5.14
70	70	0.996	240.38	-381.78	4.99	4.99
	80	0.996	211.87	-138.96	5.05	5.05
	90	0.996	195.88	66.94	5.14	5.14
80	80	0.996	186.78	-65.97	5.07	5.07
	90	0.996	213.44	87.74	5.15	5.15
90	90	0.996	267.40	137.98	5.18	5.18
Res	64.877'	0.996	197.46	-0.00	5.11	5.11
Notes:	Fld Ht = Height in electrical degrees of folded monopole section					
	Ttl Ht = Overall height in electrical degrees of folded monopole					
	and extension of return wire					
	AGT = Average Gain Test score relative to 1.000					
	Res = Source resistance in Ohms					
	React = Source reactance in Ohms					
	BS Gn = Gain in dBi broadside to the wires					
	Edge Gn = Maximum gain in dBi in line with wires					
	Res = Resonant folded monopole using the prescribed wire					
	diameters and spacing					

As we have done for the other cases, we shall break the discussion of impedances values into 2 parts for Case 3. The first set of values involves folded structures that are 10 through 30 degrees high. The general trend that we discovered for the earlier cases applies to the 3-wire models. For any folded structure, as we increase the height

of the extension, the source resistance slowly rises until we pass the 80-degree total height mark. Then the resistance declines. Interestingly, over this range of folded structures, we do not find very significant differences in the source resistance between 2-wire and 3-wire models. The reactance also slowly increases as we increase the total length of models with 10- through 30-degree folded structures. However, the inductive reactance is considerably lower for the 3-wire models than it was for the 2-wire counterparts.

When the folded structure exceeds about 40 degrees, the resistance and the reactance change more rapidly in 2-wire models than with shorter folded structures. In corresponding 3-wire models, the resistance tends to change more slowly than in 2-wire models with the same height characteristics. The first reactance zero-crossing occurs in 50-80, with the 60-n series of models showing capacitive reactance at all total heights except 90 degrees. When the folded structure exceeds about 70 degrees, the 2-wire and 3-wire source resistance values become very comparable. However, the reactance values of the 3-wire models appear to be almost uniformly shifted in the direction of inductive reactance.

The pattern of similarities and differences between 2-wire and 3-wire structures can naturalize us to the performance behaviors, but we require more detailed analysis to see if we have developed any manageable matching potential. **Fig. 9** provides the resistance data for source values up to 500 Ohms. If we can manage source resistance values up to about 250 Ohms, then the graph suggests that we may use some taller folded structures (70 and 80 degrees) in addition to the shorter 20- and 30-degrees structure suggested

as possibilities for 2-wire structures--so long as we use a relatively high total structure (>70 degrees).

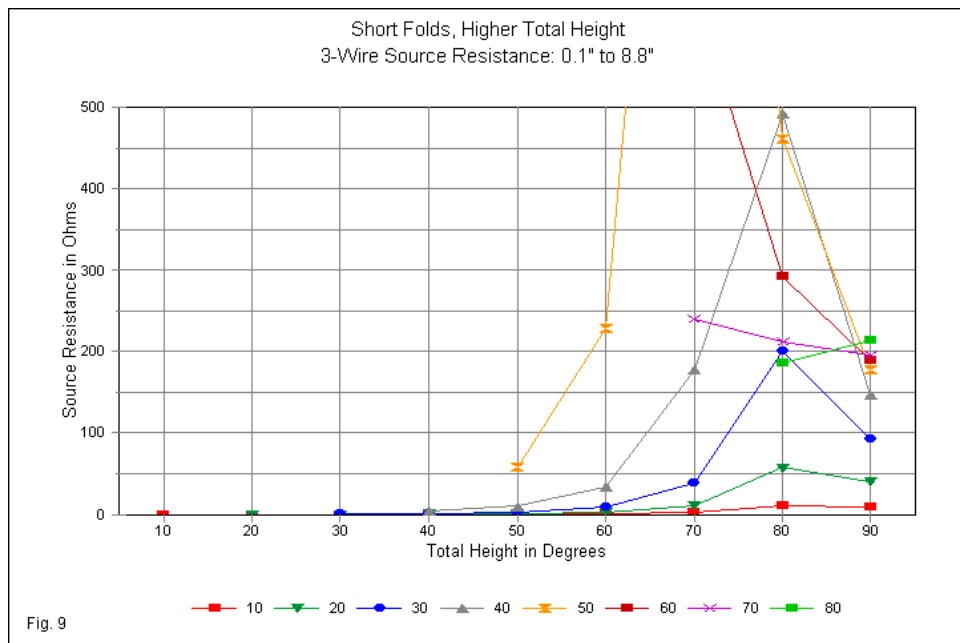

Whether any of these potentials has a usable or manageable reactance requires that we examine the graph in **Fig. 10**. The reactance values at a height of 90 degrees for the tower are well within the range of most networks. However, the rate of change for the reactances associated with the taller folded structures is somewhat steep as the value shift from capacitive to inductive between total heights of 80 and 90 degrees. The more rapid the

change in reactance with smaller height changes, the narrower the bandwidth will be for any particular set of matching component values in basic networks. Nevertheless, the slow rate of resistance changes may effect an improvement in operating bandwidth for the taller folded structures.

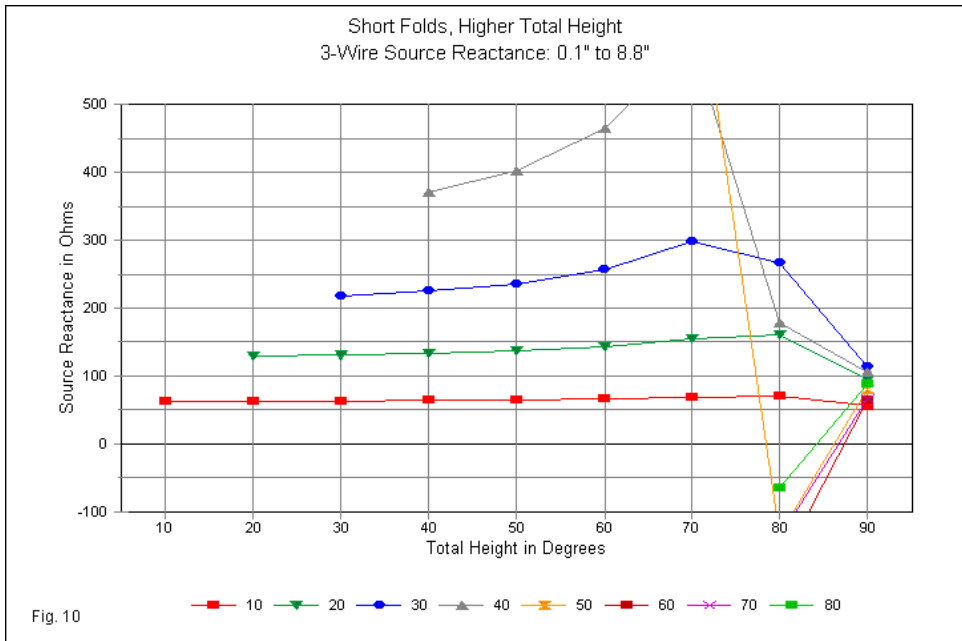

Since 3-wire systems are not very much more difficult to install than 2-wire systems, they may prove useful in a number of applications.

#### Case 4: D1 = 0.1", D2 = 8.8", Space = 36", 5 Wires

Developing a data set for 5-wire structures with 4 fed 0.1" wires and an 8.8" diameter return/extension wire requires far more effort to model than to explain. It does not matter what name we give to the structures: caged monopoles, skirted monopoles, or multi-wire folded monopoles. Central to the modeling is providing a symmetrical arrangement of the fed wires and providing each fed wire with a source. The net or parallel source impedance of the antenna will be 1/4 the value that appears on any single leg. MININEC lacks any facility for paralleling sources, so the calculation must be external to the program.

**Table 6** provides the adjusted data gathered for the series of 5-wire models. Increasing the symmetry of the structure provides another slight improvement of AGT values. As well, the 4 wires circularize the azimuth patterns, as indicated by the identical gain values in both the broadside and the edgewise columns. Once we pass very low levels of total height, the gain for the system does not vary significantly regardless of the number of wires.

Case 4	Fed Wires	Rtn Wire	Space	Freq MHz		Table 6	
5-Wire	0.1"	8.8"	36"	3.5			
Fld Ht	Ttl Ht	AGT	Res	React	BS Gn	Edge Gn	
10	10	0.984	0.002	41.32	4.64	4.64	
	20	0.989	0.005	41.51	4.69	4.69	
	30	0.992	0.018	41.89	4.73	4.73	
	40	0.993	0.056	42.44	4.78	4.78	
	50	0.994	0.165	43.27	4.84	4.84	
	60	0.995	0.523	44.64	4.90	4.90	
	70	0.996	2.077	47.33	4.97	4.97	
	80	0.996	11.738	49.26	5.06	5.06	
	90	0.996	9.588	34.23	5.16	5.16	
20	20	0.987	0.056	89.76	4.69	4.69	
	30	0.991	0.126	91.42	4.73	4.73	
	40	0.993	0.342	94.28	4.78	4.78	
	50	0.995	0.961	98.49	4.84	4.84	
	60	0.995	3.006	105.75	4.90	4.90	
	70	0.996	12.319	120.15	4.97	4.97	
	80	0.996	68.149	120.59	5.05	5.05	
	90	0.996	40.352	52.46	5.16	5.16	
	30	30	0.993	0.766	164.72	4.76	4.76
40		0.994	0.571	172.92	4.78	4.78	
50		0.995	4.244	188.12	4.83	4.83	
60		0.995	13.837	215.77	4.89	4.89	
70		0.996	66.207	272.46	4.96	4.96	
80		0.996	254.105	133.67	5.05	5.05	
90		0.996	82.057	44.29	5.15	5.15	
40		40	0.995	10.575	340.72	4.81	4.81
		50	0.995	25.227	393.83	4.84	4.84
	60	0.995	105.435	528.77	4.89	4.89	
	70	0.996	703.493	497.66	4.95	4.95	
	80	0.996	286.874	-100.40	5.04	5.04	
	90	0.996	104.679	15.45	5.14	5.15	

50	50	0.995	1266.538	1724.56	4.86	4.86
	60	0.996	1571.114	-816.19	4.89	4.89
	70	0.996	337.366	-406.27	4.95	4.95
	80	0.996	157.725	-136.01	5.03	5.03
	90	0.996	102.828	-4.27	5.13	5.13
60	60	0.996	145.453	-374.64	4.92	4.92
	70	0.996	120.143	-230.40	4.96	4.96
	80	0.996	103.482	-102.02	5.03	5.03
	90	0.996	95.225	-5.37	5.12	5.12
70	70	0.996	79.950	-126.55	4.99	4.99
	80	0.996	84.480	-65.65	5.04	5.04
	90	0.996	92.654	6.21	5.12	5.12
80	80	0.996	85.207	-21.21	5.08	5.08
	90	0.996	99.288	26.11	5.13	5.13
90	90	0.996	126.470	61.77	5.18	5.18
Res	64.40'	0.996	91.284	0.06	5.10	5.10
Notes:	Fld Ht = Height in electrical degrees of folded monopole section					
	Ttl Ht = Overall height in electrical degrees of folded monopole					
	and extension of return wire					
	AGT = Average Gain Test score relative to 1.000					
	Res = Source resistance in Ohms					
	React = Source reactance in Ohms					
	BS Gn = Gain in dBi broadside to the wires					
	Edge Gn = Maximum gain in dBi in line with wires					
	Res = Resonant folded monopole using the prescribed wire					
	diameters and spacing					

Adding two wires to the 3-wire assembly does not greatly change the net source resistance values relative to 3-wire models when both use shorter (10- through 30-degree) folded structures. Indeed, for shorter folded sections, all three series of model (cases 2 through 4) show similar resistance values. The more significant

change for shorter folded structures occurs in the level of inductive reactance. The 5-wire models show between  $2/3$  and  $3/4$  the level of inductive reactance for each step of total height for any of the shorter folded structures.

As we increase the folded structure to a height of 40 degrees or more, we find a significant difference in antenna impedance behavior relative to 3-wire models. Model 40-80 shows the first reactance zero crossing, an event that required a 50-80 combination with 3-wire models. With folded structures between 50 and 60 degrees, all of the reactance values are capacitive, including the value for a 90-degree total height. Only with folded structures at least 70 degrees high do we find an inductive reactance with a 90-degree total antenna height. However, almost all of the reactance values are quite low, suggesting the potential for broader bandwidth matching systems.



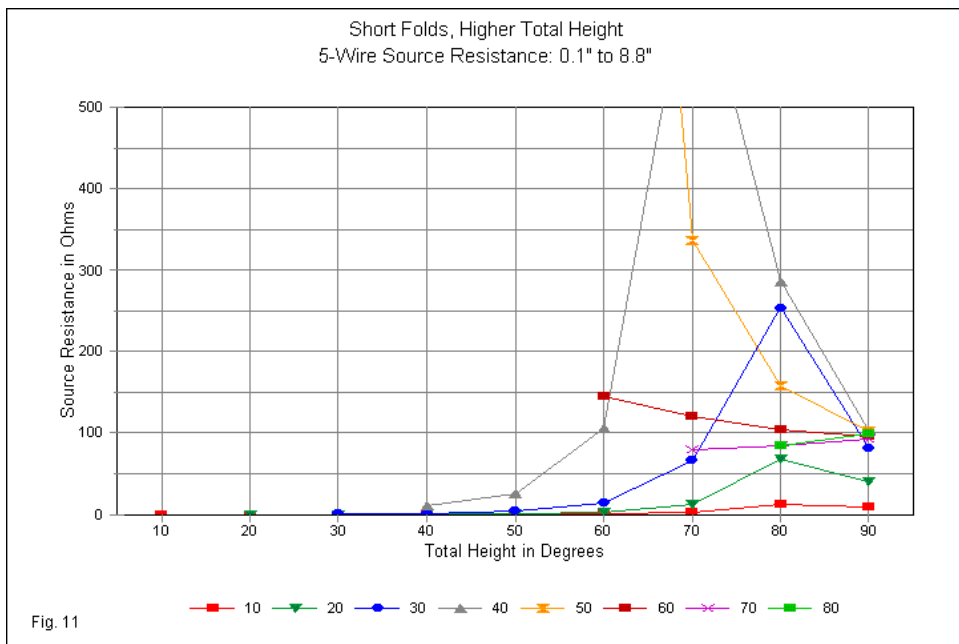

In the category of source resistance, **Fig. 11** reveals that the 5-wire assembly offers us new candidates for folded structures in terms of manageable values. In addition to the 20- and 30-degree folded structures, we may add 60-90 degrees, with total lengths equal to or longer than the folded structure.

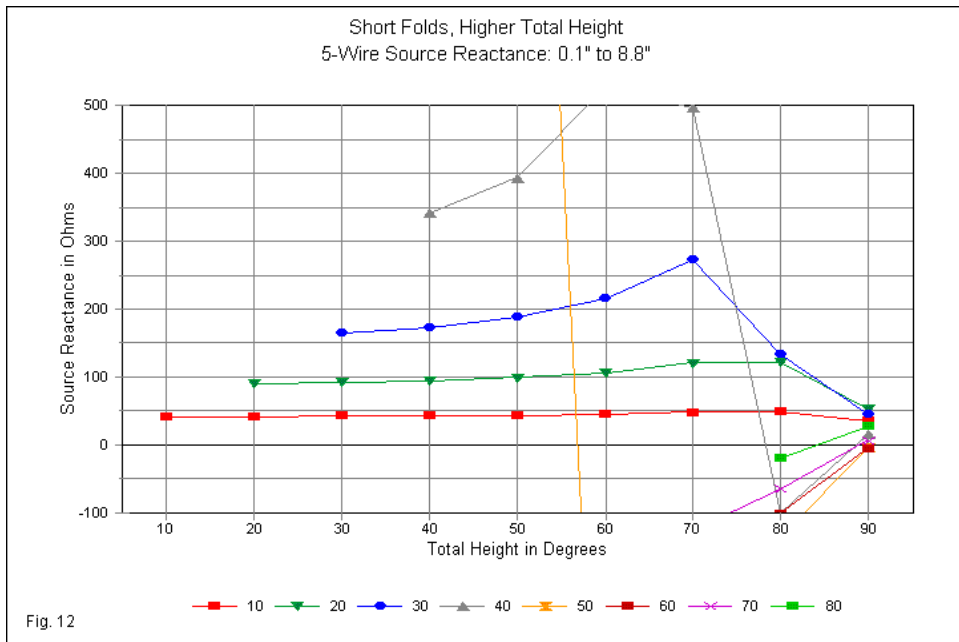

With a total height of 90 degrees, **Fig. 12** informs us that almost any of the resistance candidates will suffice in terms of feedpoint reactance. As we lower the total height to 80 degrees, even the tallest folded structures show less steep curves than for any of the preceding models series. Even a 60-degree folded structure will work well with an 80-degree total height if we can handle a moderate amount of capacitive reactance.

The 5-wire short folded monopole with extensions expands the number of options available to the application of folded structures to

grounded vertical towers. These notes have not explore antenna lengths greater than 90 degrees, so we cannot say off hand whether the advantages of multiple feed wires continue with taller towers.

## Matching and Planning

In the course of these notes, I have noted that most amateurs who feed existing towers for use on one or more of the lower bands prefer to arrive at an assembly that provides inductive reactance. In many cases, the operator will sacrifice operating bandwidth for the inductive reactance. Indeed, they prefer to arrive at a source resistance that is less than 50 Ohms along with the inductive reactance. We may fairly ask why this custom prevails.

Some Typical Low-Loss Matching Networks

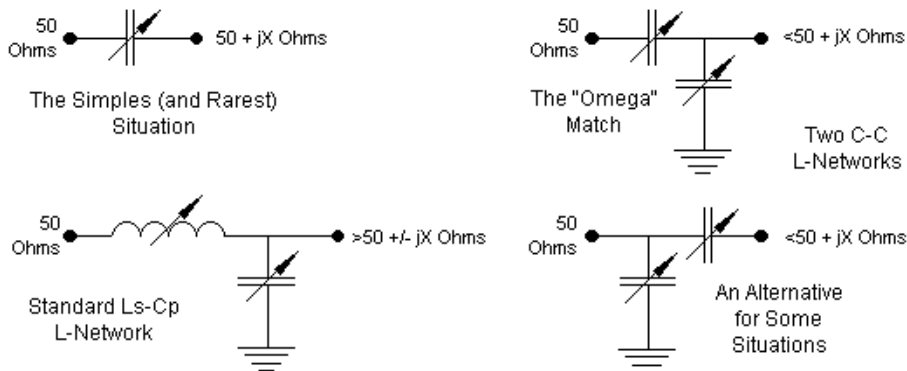

Fig. 13

**Fig. 13** provides part of the answer. Under ideal conditions, we can effect the required matching to a coaxial cable with a simple series capacitor, if the antenna feedpoint shows a near-50-Ohm resistive component along with inductive reactance. The upper left sketch shows the condition. If the impedance is less than 50 Ohm resistive and has inductive reactance, then we may use the 2-capacitor matching scheme at the upper right. Since the scheme is a simple L-network, it is not clear why the label "omega" match persists, since nothing in the network resembles the Greek letter in either upper or lower case forms. For many combinations of impedances with under 50 Ohms resistance and an inductive reactance, the system at the lower right will also work. However, it does not always yield the most desirable values (usually meaning the lowest values) of capacitance in either the series or the parallel leg.

For general matching with resistances above 50 Ohms, we normally require the L-network configuration shown at the lower left in **Fig. 13**. The sketch shows perhaps the most familiar form of the L-network, often used with horizontal long-wire antennas. However, it functions very well with impedance that are near to 50 Ohms with various levels of inductive or capacitive reactance. Tower shunt feeders have in the past rejected this configuration--and the impedances that require its use--because they have preferred to match entirely with capacitors. One may match a given impedance over a narrow operating bandwidth with fixed weatherproofed capacitors at the base of the antenna. Vacuum variables can provide fairly weatherproof remote service to vary the match.

The desire to remotely match an antenna for upper MF and lower HF amateur service makes sense if we consider some of the impedance values that appear in the literature. One set of values involved a resistance of 17 Ohms and a reactance of 580 Ohms. Even if we had a resonant condition, the SWR would begin at 3:1 relative to 50 Ohms and become progressively worse with increasing reactance. With the very high reactive component, the SWR is in the hundreds.

An alternative offered by multi-wire folded structures is a reduction in the reactance to levels that may not require remote matching. Some of the 5-wire models showed resistance values in the 90s as the total height approached 90 degrees. The inherent SWR relative to a 50-Ohm line is under 2:1 with those conditions. If we raise the reactance to perhaps 100 Ohms (capacitive or inductive, the SWR climbs to about 4.3. If we use 100' of low loss cable (such as LMR600) and reserve matching for inside the operating room, we lose about 1/3 dB. A simple L-network at or near the operating position will effect the required match with little or no concern about the durability of components as the weather passes through its many potentially destructive cycles.

The possibly attractive alternative, of course, rests on the numbers yielded by the sample models, with all of the qualifications and reservations recorded along the way. Making such a system work in a specific application requires far better modeling, along with considerable preliminary field effort. At a minimum, a proper model should include all of the details shown in **Fig. 14**. The tower needs full modeling, as do the specific wires to be used as fed wires in the

folded portion of the structure. Not only should the model include any extension of the tower, but as well, it should include any mast and beam antenna at the top. In addition, the model should specify the materials for each wire within it, with different values for material conductivity wherever they occur. Only then will the model accurately reflect the above-ground structure and its equivalent electrical length. Of course, the many junctions of wires having different diameters will force the use of MININEC, since a NEC model has a very high probability of being unreliable.

A "Full" Planning Model

Fig. 14

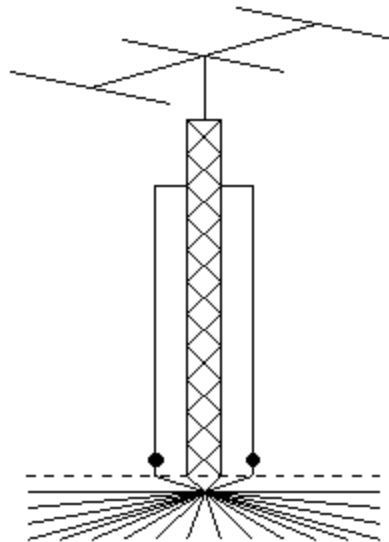

The below-ground structure has equal importance. A buried radial system deserves below-ground modeling in NEC-4. If we try to substitute the MININEC ground with a set of specifications for conductivity and relative permittivity, we would obtain the impedance for a perfect ground. To resolve the incompleteness of one system without the other, the modeler can first model the antenna structure as a whole in MININEC. Then he or she can develop a simplified substitute model have essentially the same characteristics, but using throughout a single wire diameter. (In many cases, this phase of the effort may require the most ingenuity.) Finally, one may transfer the model to NEC-4 for completion with the buried radial system to be used in practice.

Of course, Murphy's Law tells us that the individual who bypasses this process and uses initial estimates will spend long days in the field adjusting and readjusting the system because reality and the initial estimates are far apart. Equally, someone who goes through the entire process will conclude that the initial estimates proved to capture reality as well as the most detailed model. Such is the lot of shunt feeders.

The brief account of detailed planning requirements serves to reinforce my initial notes to the effect that these case studies only establish the interesting patterns of short folded monopole and extension behavior. They do not provide precision guides to building such structures. However, patterns can be useful in familiarizing us with the territory so that what we encounter has fewer surprises. Surprise on the battlefield is an effective offensive weapon. Surprise with antennas is usually simply offensive.

## Chapter 34: A Doublet as a Good Single Choice Antenna

**S**uppose I wanted to work 40 through 10 meters. And further suppose that I want to know where my signal is going. Now what would I choose?

### The 40-Meter Dipole Starting Point

The most common answer to the problem I just posed is a 40-meter #12/#14 copper wire dipole, fed with parallel transmission line for use as a multi-band doublet. **Fig. 1** tells the simple construction tale.

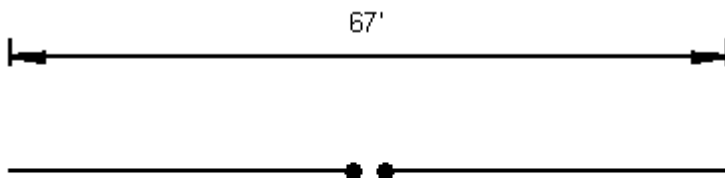

**Fig. 1**

7.15 MHz Dipole, #14 wire

Placed high enough in the air, the 67' doublet performs very well. Its bi-directional pattern on 40 has good side QRM rejection, and with enough altitude, the elevation angle makes DX a real potential with every band opening. Let's place the antenna at a height of 66'



(about 20 m) up and see what the models tell us that we can expect by way of performance.

Freq. MHz	Max. Gain dBi	TO Deg	VBW Deg	HBW Deg	Feedpoint Z R +/- jX Ohms
7.15	7.3	28	35	86	70 - j 10
10.1	8.1	20	23	70	275 + j 800
14.15	9.0	15	16	51	4670 - j 345
18.1	10.5	11	12	33	175 - j 860
21.2	8.4	10	10	33	100 - j 115
24.95	9.3	8	9	33	375 + j 730
28.5	9.5	7	8	28	3265 + j 375

The TO angle is the elevation angle of maximum radiation. I have also provided information on the vertical and horizontal beamwidths (measured to the -3 dB points from the maximum strength bearing). We often neglect this information, but the data tell us some important facts. The vertical beam width is a rough measure of the range of elevation angles that we can count on for good communications. The horizontal beamwidth tells us how broad or narrow our signal is and hence how careful we must be in aiming the antenna--either when we build it or when we rotate it. (One of the amusing facets of reading lots of e-mail is discovering how many beam users demand 1-degree aiming accuracy when their beamwidths are well over 50 degrees.)

The 67' doublet shows the anticipated lowering of the TO angle as we increase frequency. As we increase the frequency, the antenna is increasing in electrical height, that is, its height as a fraction of a wavelength. So we expect the beam angle to be lower on the upper bands. The beam widths--both vertical and horizontal--narrow with rising frequency. Still, the vertical beamwidth is wide enough on all

bands to catch the main stream of long-range skip. And the horizontal beamwidth is sufficiently broad to make aiming non-critical (but not unimportant).

The range of impedances at the antenna suggests that with a parallel transmission line and an ATU, we should be able to effect a match on all bands. 20 and 10 meters might present slight problems, but changing the line length will likely solve them by presenting the ATU with impedance values it can handle.

However, the gain column presents us with a small problem. The maximum gain of the 67' doublet occurs on 17-meters, takes a large dip above that band, and then slowly rises once more. For a simple wire, the actual gain numbers are not the problem. The question we want to ask is this: why does the dip occur?

Azimuth Patterns  
40-Meter Doublet  
7.15, 21.2, 28.5 MHz

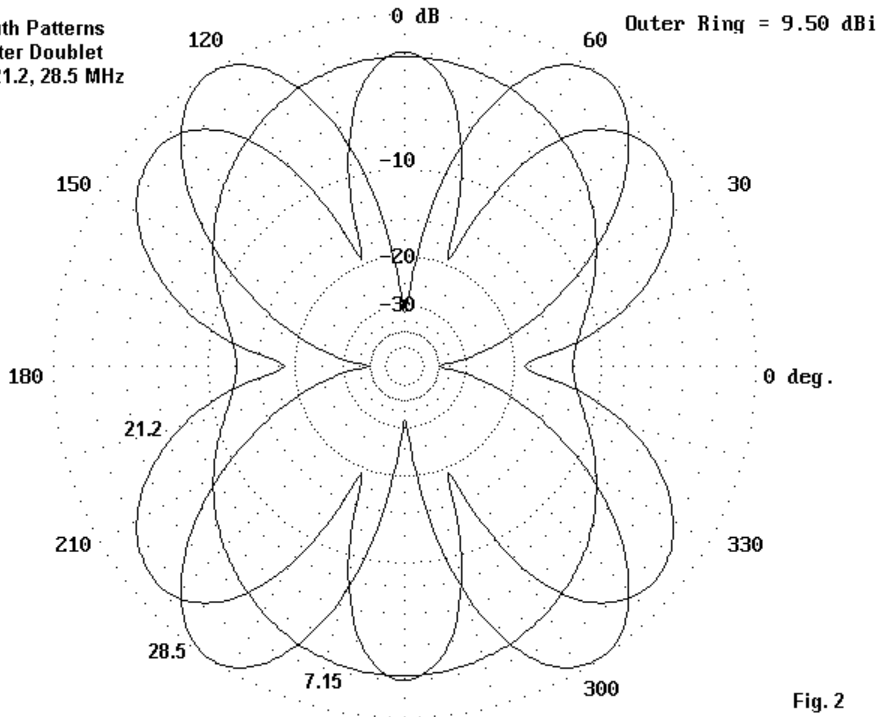

Fig. 2

**Fig. 2** can help us figure out what has occurred. The azimuth patterns overlaid on the plot are for 40, 15, and 10 meters. The 40-meter pattern is the typical oval. As we increase frequency, the oval grows narrower (decreasing horizontal beamwidth) while the gain increases--up to 17 meters. On this band, the 67' doublet is about 1.25 wl long: an extended double Zepp (EDZ). We expect about 3 dB gain over a dipole from an EDZ, and if we compare the 40-meter and 17-meter gain figures, we can see that we get it.

Above 17 meters, the antenna is longer than 1.25 wl. At 15 meters, the antenna is about 1.5 wl long. The main lobe is no longer broadside to the antenna, but, as shown in **Fig. 2**, it is broken into 6 distinct lobes. The lobes broadside to the wire are no longer the strongest. As we move into the 10-meter region, where the antenna is 2 wl long, we have a pattern composed of 4 lobes at roughly 40-degree angles to the wire.

For those unfamiliar with pattern development as an antenna becomes multiple wavelengths long, the following rules of thumb apply. For an antenna that is  $N$  wavelengths long, where  $N$  is an integer (like, 1, 2, 3), the number of lobes is twice the value of  $N$ . So a 2 wl antenna has 4 lobes, and a 1 wl antenna has only 2. For antenna lengths that are  $N.5$  (like 1.5, 2.5, etc.), the number of lobes will be the sum of the number of lobes we get at  $N$  and at  $N+1$ . At 15 meters, where the antenna is 1.5 wl long, 1 wl gives us 2 lobes and 2 wl gives us 4 lobes, for a total of 6. The higher number at  $N.5$  wl values arises because the new lobes are growing and the old ones shrinking--and they are nearly equal strength at the  $N.5$  wl points.

## The 44' Wire Solution

The problem with wire lengths over 1.25 wl is that we are no longer sure that we have a good signal broadside to our antenna. Suppose I put up a wire in Tennessee, running it NW to SE. That makes it broadside to Europe in one direction and to VK/ZL-land in the other. Not a bad set up. However, the main lobes for frequencies from 21 MHz up are no longer going where I want them

to go. (Where they go may result in interesting contacts, but we set up our problem at the beginning so that it includes the need to keep our signals where we want them.)

There is a simple solution to this problem, but it may not be the one some folks would expect. Conventional wisdom tells us always to make antennas bigger and longer. However, the solution to our problem is to make our doublet shorter. Let's try a doublet that is 44' long, as in **Fig. 3**. Again, #14 or #12 AWG copper wire will do just fine for the antenna.

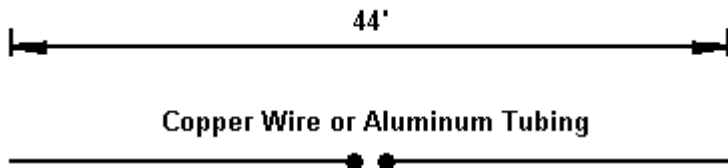

**10 Meter Extended Double Zepp  
(44' Doublet)**

**Fig. 3**

The first question we may now ask is whether we lose anything with the shorter wire. Let's find part of the answer in another table, modeled with the copper wire (#14 AWG) antenna 66' above average ground.

Freq. MHz	Max. Gain dBi	TO Deg	VBW Deg	HBW Deg	Feedpoint Z R +/- jX Ohms
7.15	7.0	29	35	94	25 - j 580
10.1	7.6	20	23	83	55 - j 100
14.15	7.7	15	16	72	195 + j 485
18.1	8.6	12	12	60	920 + j1565
21.2	9.0	10	10	51	4160 + j 155
24.95	10.4	8	9	40	520 - j1545
28.5	10.4	7	8	31	140 - j 650

The gain figures begin about a quarter dB below the figures for the 67' doublet on 40 meters and climb steadily. The elevation angles of maximum radiation and the vertical beamwidths are virtually identical to those for the longer doublet. The shorter antenna provides a broader horizontal beamwidth on every band, which makes aiming less critical. The pattern of impedances offered at the feedpoint differs in detail from that of the longer doublet, but the values are manageable. However, see the cautionary note below.

To see one of the major advantages of our short doublet, we should look at **Fig. 4**.

Azimuth Patterns  
44' Doublet  
66' High

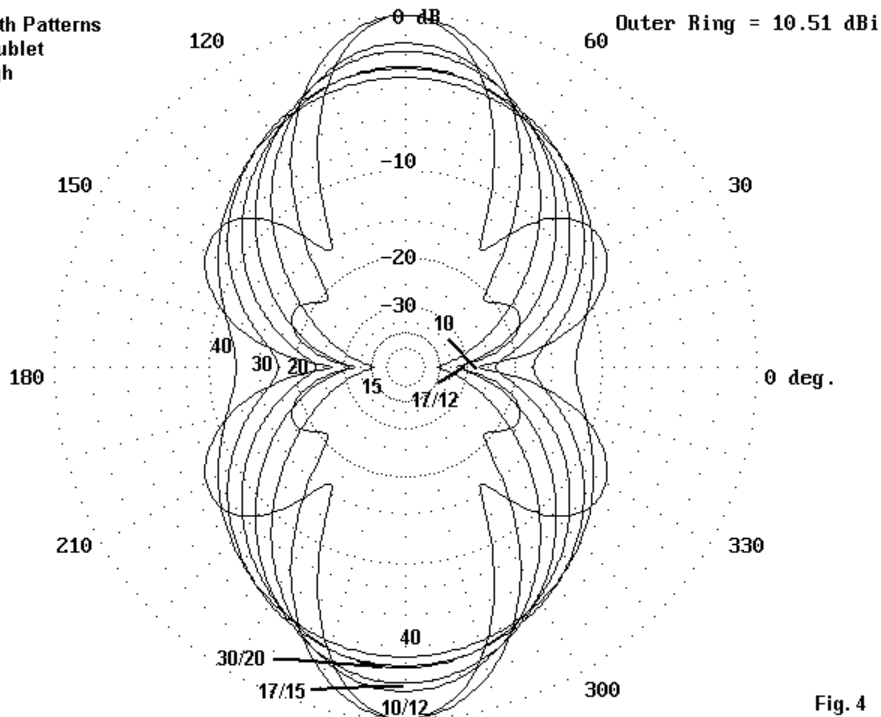

The composite azimuth patterns for the doublet on all of the bands for which it is intended have their major lobes exactly broadside to the wire. The 44' length was no accident. On 10 meters, this length is about 1.25  $wl$  long, the standard EDZ length. The 10-meter pattern shows the anticipated strong main lobes plus the emerging "ears," secondary lobes that will become the major lobes at higher frequencies. On 15 meters, the antenna is about 1  $wl$  long, and on 30 meters it is just under the right length for a half  $wl$  dipole (which

is indicated by the low resistive impedance and the capacitive reactance for 10.1 MHz). On 40 meters, the antenna is between  $1/3$  and  $3/8$  wl long, about the minimum length we should use. Anything shorter would show very low resistance values and very high reactance values--a difficult situation for any ATU to handle.

If I wanted to aim at both Europe and at Australia and New Zealand on all bands from 40 through 10 meters, then the 44' doublet is the superior antenna to the longer 67' doublet. Of course, larger (102' or 135') all-band doublets break into fragmented lobe patterns at lower frequencies than the 40-meter dipole with which we started. So, if we make aiming one of the criteria for our antenna, the 44' doublet may be the way to go.

Two side notes. First, if we want to cover the bands only up through 20 meters, but want to include 80 and 75 meters within the frequencies for which we are well-aimed, then an 88' doublet might meet our needs. Of course, there is nothing magic in the precise length numbers chosen, since a length change of a foot or two will change almost nothing in terms of performance. The bands with the highest reactances at the feedpoint might show the greatest change in value as we alter the antenna length, but the feedpoint values on the other bands would hardly change enough for an ATU to notice.

For either the 88' or the 44' doublet, the lowest band of use (80/75 and 40, respectively) present challenges in line losses and matching at the shack end of the line. Hence, the short doublet--



only  $1/3$  to  $3/8$  wavelength on the lowest band--should be considered as a back-up antenna on those bands.

Second, height is a major consideration with this sort of antenna. Perhaps 66' is not feasible for everyone. However, every foot of (safe) height that you can add to the antenna, the better it will work. This principle goes back to the days of George Grammer of ARRL, who preferred to add height rather than elements to his antennas. The idea is no less true today, although there are some limits. Once we get above 1 wl, there may be some holes in our DX elevation-angle coverage at certain antenna heights. However, in Grammer's day, only on 10 meters and VHF did most hams think about heights above 1 wl or so.

### The Aluminum Alternative

There is no good reason why a single element antenna must be constructed from thin wire--excepting cost and ease of construction. If there is only one support that is high enough, then we might well consider constructing an aluminum tubing version of the 44' doublet. **Fig. 5** shows one of many possible schemes for constructing the element. The wind survival rating for this scheme is about 70 mph.

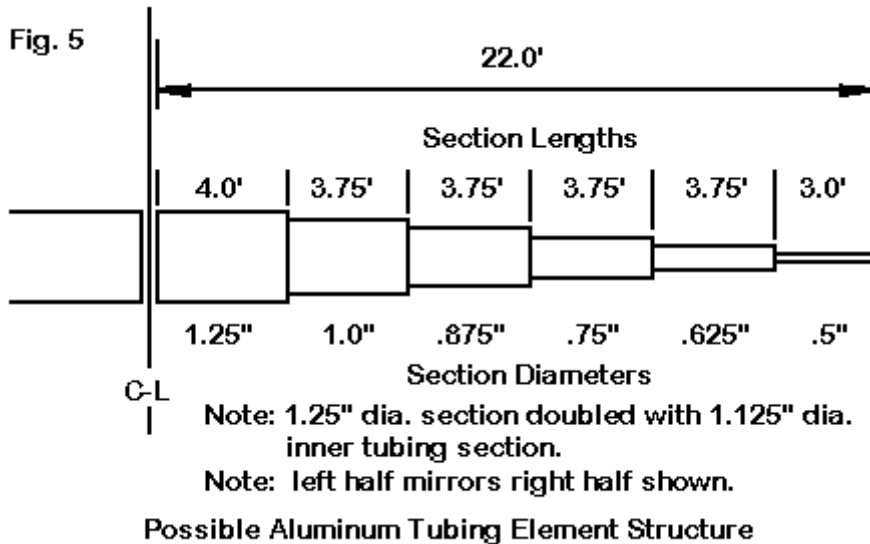

In tabular form, the element structure looks like the following partial antenna model description.

----- WIRES -----

Wire Conn.---	End 1 (x,y,z : ft)	Conn.---	End 2 (x,y,z : ft)	Dia(in)	Segs
1	-22.000, 0.000, 66.000	W2E1	-19.000, 0.000, 66.000	5.00E-01	3
2	W1E2 -19.000, 0.000, 66.000	W3E1	-15.250, 0.000, 66.000	6.25E-01	4
3	W2E2 -15.250, 0.000, 66.000	W4E1	-11.500, 0.000, 66.000	7.50E-01	4
4	W3E2 -11.500, 0.000, 66.000	W5E1	-7.750, 0.000, 66.000	8.75E-01	4
5	W4E2 -7.750, 0.000, 66.000	W6E1	-4.000, 0.000, 66.000	1.00E+00	4
6	W5E2 -4.000, 0.000, 66.000	W7E1	4.000, 0.000, 66.000	1.25E+00	9
7	W6E2 4.000, 0.000, 66.000	W8E1	7.750, 0.000, 66.000	1.00E+00	4
8	W7E2 7.750, 0.000, 66.000	W9E1	11.500, 0.000, 66.000	8.75E-01	4
9	W8E2 11.500, 0.000, 66.000	W10E1	15.250, 0.000, 66.000	7.50E-01	4
10	W9E2 15.250, 0.000, 66.000	W11E1	19.000, 0.000, 66.000	6.25E-01	4
11	W10E2 19.000, 0.000, 66.000		22.000, 0.000, 66.000	5.00E-01	3

The construction shown in the figure should be designated light to medium for the element length involved. It is based upon purchasing 8' lengths of aluminum and cutting them in half. Prices for 6061-T6 aluminum tubing from sources such as Texas Towers and others are quite reasonable. The tapering scheme allows for about 3" of tubing overlap at every junction. Any less overlap would jeopardize physical strength, while too much more overlap will unnecessarily increase the element weight. The double section of 1.25" and 1.125" diameter tubing at the center provides reinforcement for most mounting schemes.

Some builders prefer to alternate longer and shorter sections of tubing for greater overall strength. Whatever scheme one uses, analyzing it through a program such as YagiStress by Kurt Address can go a long way toward ensuring a mechanically sound antenna. Nonetheless, the 44' doublet is only about 9' longer than most 20-meter Yagi reflectors and a good bit shorter than the elements used for 30-meter and 40-meter Yagis. Hence, the use of an aluminum tubing element is certainly feasible.

**Special Note:** Carroll Allen, AA2NN, pointed out the taper schedule suggested would have a wind survival rating of only about 70 mph. He developed a spread sheet for EXCEL to calculate the stress on the tubing. For commonly used antenna tubing, such as 6061-T6, with a wall thickness of 0.058", the maximum stress for each section should be 40,000 psi or less. He kindly redesigned the sections for a 100 mph wind survival rating. The following table presents the revised taper schedule. Like the original schedule, the

1.125" diameter section is presumed to run all the way through the 1.25" section, but also to have its own exposure length.

44' Aluminum Doublet Half-Element Structure  
for 100 MPH Wind Survival

Diameter (")	Section L (")	Cumulative L (")
1.25	72	72
1.125	19	91
1.0	20.5	111.5
0.875	21.5	133
0.75	23	156
0.625	24	180
0.5	84	264

The use of aluminum tubing provides a small but determinate increase in electrical performance for the doublet. As we increase the diameter of an element, the RF resistance decreases considerably. Although copper wire is certainly efficient enough for most purposes, the tubing version of the antenna shows an increase in efficiency, despite the fact that the tubing version user aluminum, which has a higher resistivity than copper.

Frequency MHz	#14 Copper Wire Efficiency (%)	Stepped-Dia. Aluminum Efficiency (%)
7.15	96.98	99.70
28.50	98.35	99.77

Notice that the differential in efficiency grows less as the frequency increases, that is, as the wire diameter becomes a greater fraction of a wavelength. Nonetheless, the tubing version shows systematically higher gain values for each band than the wire version of the 44' doublet. Compare the following table with the copper wire table given earlier.

Freq. MHz	Max. Gain dBi	TO Deg	VBW Deg	HBW Deg	Feedpoint Z R +/- jX Ohms
7.15	7.2	29	35	94	20 - j 410
10.1	7.7	20	23	83	50 - j 85
14.15	7.8	15	16	72	195 + j 295
18.1	8.7	12	12	60	1005 + j 845
21.2	9.1	10	10	51	1700 - j 705
24.95	10.5	8	9	40	285 - j 795
28.5	10.5	7	8	31	100 - j 375

The gain differences are certainly not large enough to make any kind of operational difference in using the 44' doublet. At most, they help us better understand some of the variables involved in antenna structures.

Notice also that the feedpoint impedance figures vary from the wire values more radically as the frequency increases--and also where the resistance or reactance values are high to begin with. The values shown--which will vary considerably as one changes the precise length of the finished antenna--are nonetheless quite manageable by most ATUs.

Supporting an aluminum doublet of the size we are suggesting is a considerable project. **Fig. 6** shows the main aspects of the things we should consider.

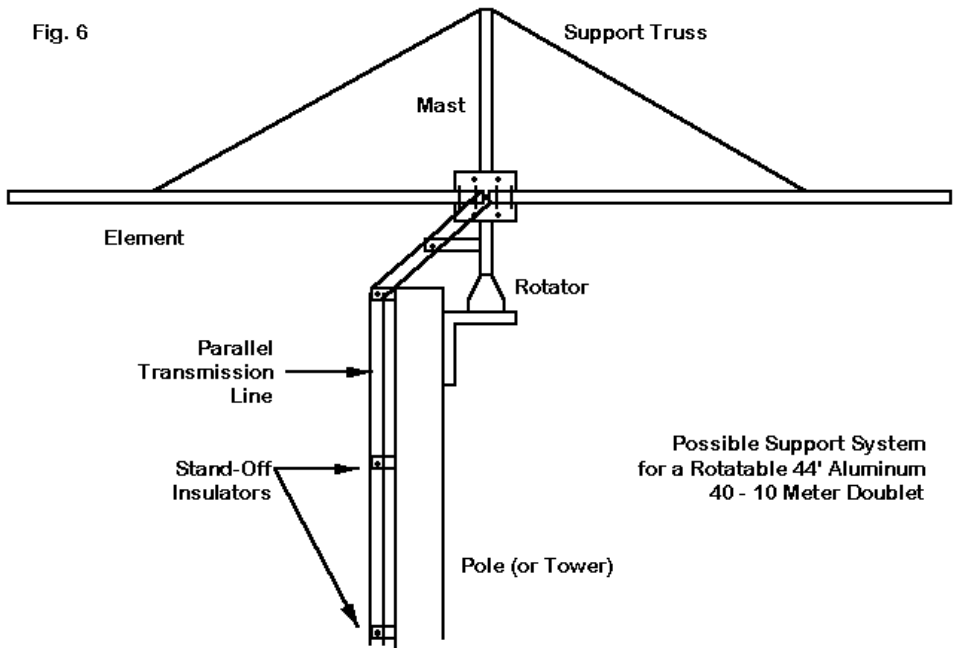

1. We shall need a support tower or pole as tall as we can safely make it. Although I know some inveterate climbers much older than I am who regularly scale high towers, my own experience tends to decrease my tower height by one section for every decade older I get. Safety comes first; antenna height second.

2. As I doodled the sketch in **Fig. 6**, I added a rotator for the fun of the prospect. We only need about 180-degrees rotation for this doublet, so a side mounting on an existing tower would likely be

good enough. For sample photos of one version of this antenna constructed from tubing and able to rotate with a CD44 rotator, see the web site of [Adam, N4EKV](#). (Today's cheap TV rotators are no longer able to handle this antenna, but 25 years ago. . .)

3. For elements 40' and longer, consider adding a top-mounted truss to help support the element. A truss system will require a longer mast than truss-less elements. The exact position on the element to place the ends of the truss depends a great deal on the precise element diameter schedule chosen. Use a weather and UV resistant material for the truss rope.

4. Since the antenna will use parallel transmission line, stand-off insulators will be necessary. If the antenna is to rotate, the position of the line from the feedpoint to the stationary supports on the pole will require considerable planning. The line should avoid close proximity to any metal in the mounting region.

5. The parallel transmission line is low loss inherently when the runs follow standard handbook recommendations. However, for lowest losses, consider true open-wire line rather than vinyl-coated lines. Even lines with "windowed" openings in the vinyl between the wires tend to show higher losses when wet than when dry. Line losses will generally be low except for the lowest band in the range shown.

6. When the antenna feedpoint impedance is disproportionately reactive, you can expect difficulties effecting a match with an antenna tuner. On the lowest band, the 3/8-wavelength wire has an

impedance where the reactance is 20 times the resistance. Under these conditions, the ability of a tuner to effect a match between the impedance at its terminals and the standard 50-Ohm coax to the rig will depend both on the line and the tuner configuration. Line concerns involve an interaction between the line length and the characteristic impedance. As well, even high-efficiency parallel lines will add losses to the already lower performance on the lowest band in the usable antenna range. To avoid tuner damage, tune up using low power and then raise power to the operating level.

Like all antennas, preventive maintenance at least once per year (every 6 months is better) will go a long way toward preventing unexpected catastrophic failures.

However, you decide to construct a single-element antenna, the 44' doublet has some interesting properties that provide advantages over other types of multi-band doublets. It is an antenna worth considering--if you can have only one wire.

The use of the 44' length--or more properly, the approximate length of a 1.25 wavelength wire at 10 meters--is not new. It dates back to at least the middle of the 20th century. For example, Gene Fuller, W2LU, in the July, 1966, issue of *CQ* wrote an article on using 42' wires in a set of phased arrays ("Beam Antennas for the H.F. Range," page 12).

The 44'-wire exercise is designed mainly to encourage antenna builders to think "outside the box" of antennas that are naturally resonant at some operating frequency or at the lowest operating



frequency. Resonance is not a requirement of good performance. Hence, we are free to set some one or more other goals for our antenna. In this case, we have set the goal of having radiation patterns that are broadside to the wire. For 40-10 meters, the 44' wire fulfills this goal, however, close to or far from resonance its length may be on any one of the bands covered.

## Chapter 35: Inverted-Vee Doublet Patterns

**A** common all-band doublet for smaller ham properties is the inverted-Vee, usually cut to either 135' or to 67' (or thereabouts since the exact dimensions are not critical for an antenna fed with parallel line and an antenna tuner). The question that recurs is whether the Vee works as well as the level or flat-top doublet of the same length.

The answer depends on 2 factors. One factor is the frequency of use. The other factor is the angle of the Vee wires relative to the level doublet. To see what difference each of these factors make, let's look at the doublets in **Fig. 1**.

The basic length of the doublet will be 67' for a fundamental frequency of 40 meters. We shall look at both azimuth and elevation patterns for 40, 20, 15, and 10 meters, on frequencies about mid-band in each case. However, the patterns will not change from one end of a band to the other.

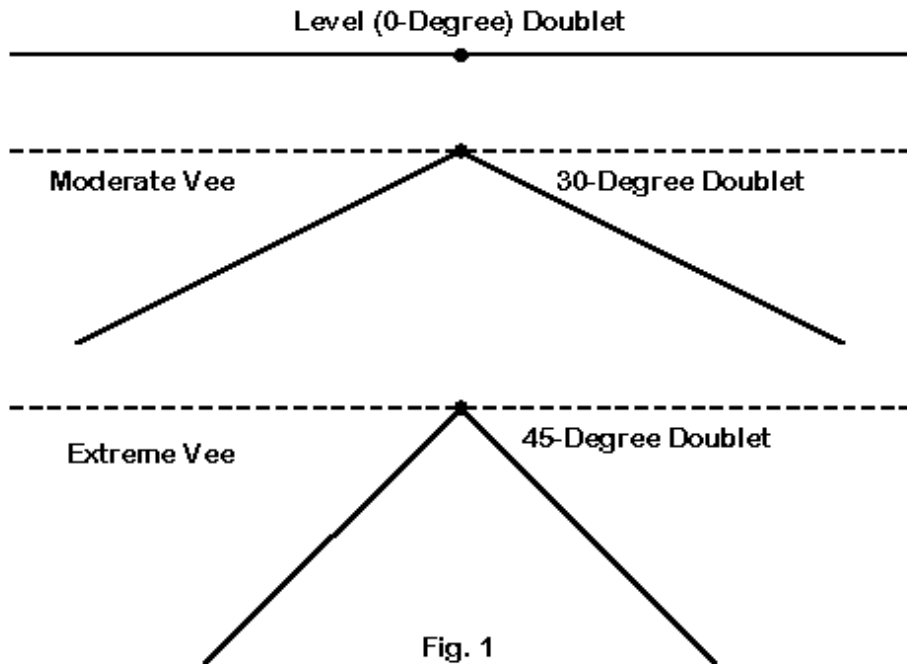

We shall look at patterns for the level doublet as a sort of baseline against which to measure the patterns of the 2 Vee versions. One version will be a moderate Vee that slopes downward only 30 degrees relative to the level doublet. The other Vee version will slope downward 45 degrees. Together, the two Vees will give us a picture of the trend in pattern change for intermediate or even more radical slopes.

In some cases, Vee patterns will be weaker, that is, have no lobes as strong as the strongest lobes of the doublet. Does that make the Vee a poorer antenna? Not necessarily. In each case, look also at the shape of the pattern and the strength of the lower angle elevation lobes. It will be the evaluation of all of the pattern features that will tell you which version of the doublet is best for your operation. This assumes, of course, that some kind of doublet is best in the first place. On 40 meters, there is really very little to choose between a flat doublet and a Vee. The elevation angle of maximum radiation climbs upward as we make the Vee slope more radically. It changes from 38 degrees for the flat-top to 46 degrees for the 45-degree Vee. However, in all three cases, the elevation lobe is so vertically broad that the differences are unlikely to make a detectable difference in performance.

Azimuth Patterns  
40 Meters

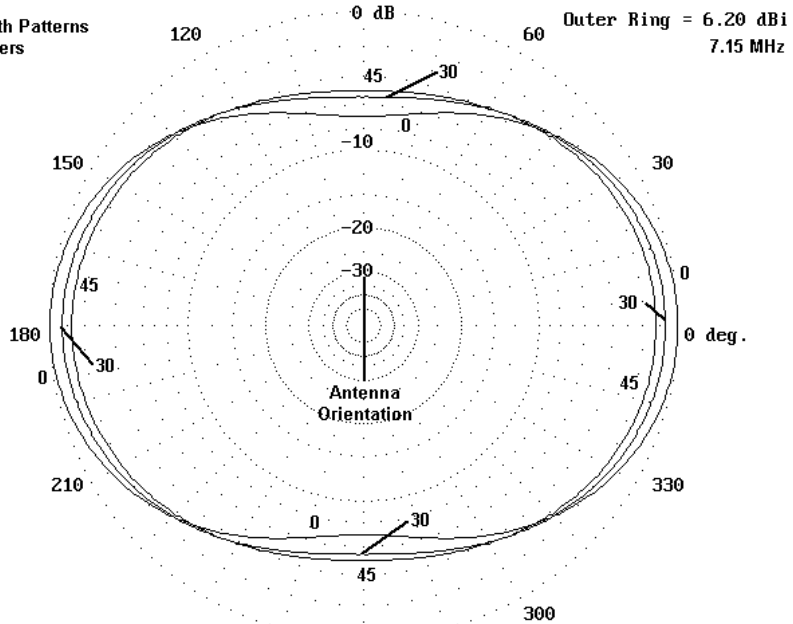

Elevation Patterns  
40 Meters

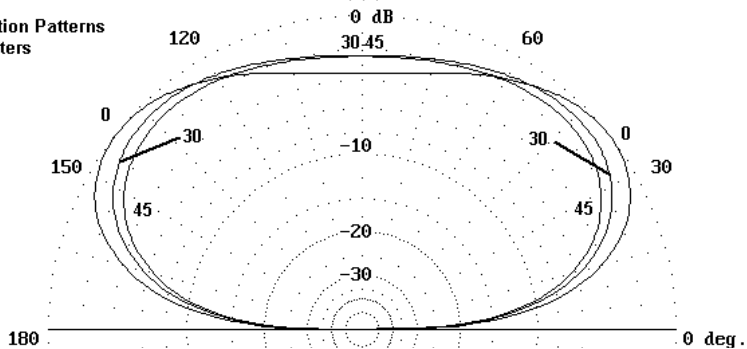

Likewise, there is a slight difference in the strength of the main lobe broadside to the antenna, which is 50' up at the center in these patterns. A difference of 1-2 dB is not likely to be detected by the user without high-cost lab equipment. (That is why we rarely detect reduced performance due to the lack of antenna maintenance until the antenna falls down.) So on 40 meters, A Vee and a flat-top are about equal.

Azimuth Patterns  
20 Meters

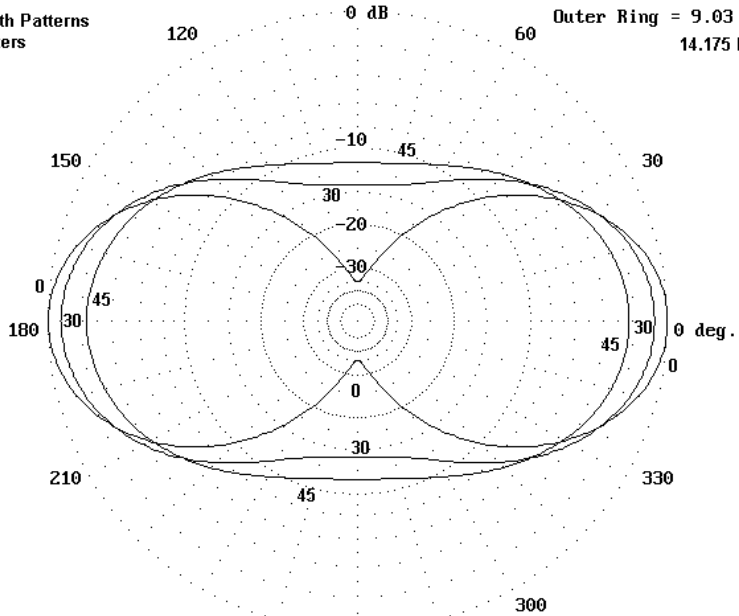

Elevation Patterns  
20 Meters

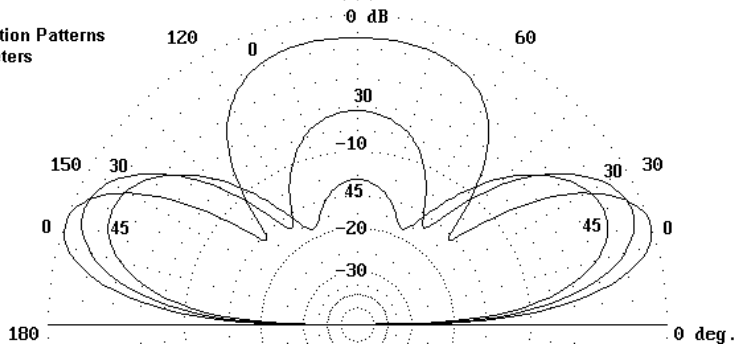

On 20 meters, where the doublet is about 1 wavelength long, we begin to see significant differences. The elevation angles of maximum radiation climb from 19 degrees for the flat-top to 25 degrees for the 45-degree Vee. As well, the gain drops by over 3.5 dB as we increase the slope of the Vee, although most of that drop occurs in the move from 30 degrees of slope to 45 degrees.

However, notice the shape of the azimuth patterns. The flat-top shows extremely deep side nulls (off the ends of the wire). The user can look at these nulls as QRM fighters or as directions in which almost no QSOs are possible even under the best propagation conditions. The lesser nulls of the two Vees offer some hope of contacts, although condition might have to be very good to get them.



Azimuth Patterns  
15 Meters

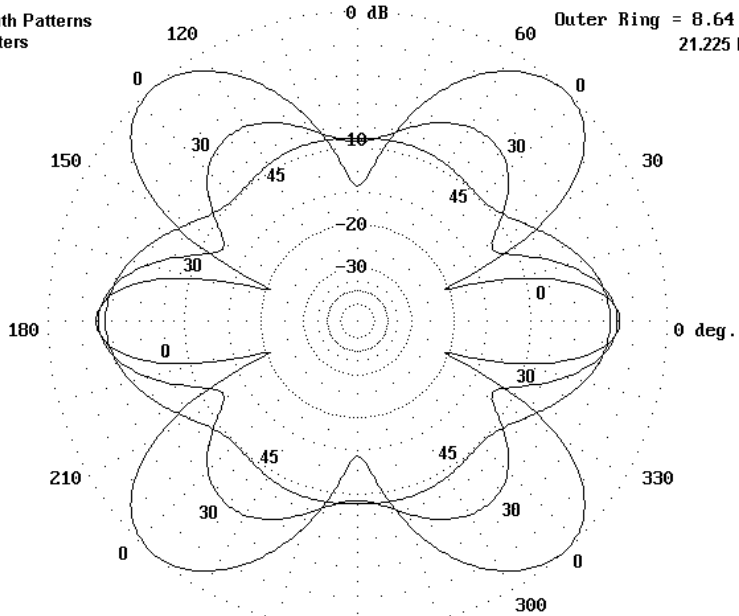

Elevation Patterns  
15 Meters

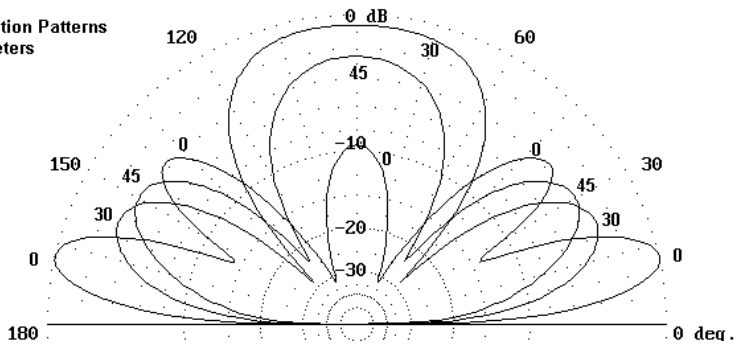

On 15 meters, the situation becomes a good bit more complex, perhaps even more complex than the maze of lobes and nulls in the combined sets of patterns. The flat-top has the strongest lobes by far, although the four best are fairly narrow in width. If these lobes happen to go exactly where you want them to go, then all is well. If not, then they may radiate where no one lives. Antenna orientation is important.

The broader patterns of the Vee antennas offer slightly weaker but more uniform propagation in most directions. However, nothing is perfect. Note the elevation patterns, which show almost all radiation to be at higher angles in the 23 to 30-degree range on a dx band that does best when radiation is at much lower angles. The flat-top take-off angle is 13 degrees, just about right if the lobe points at a target.

Azimuth Patterns  
10 Meters

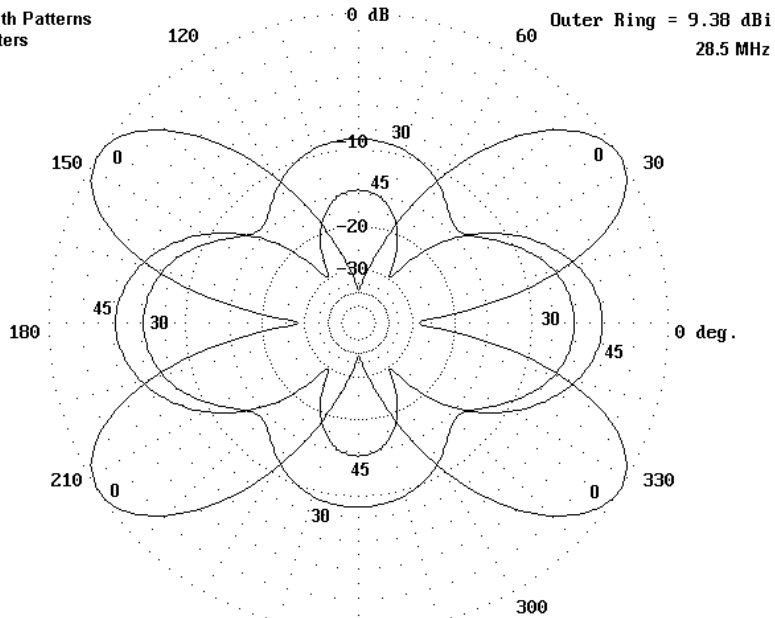

Elevation Patterns  
10 Meters

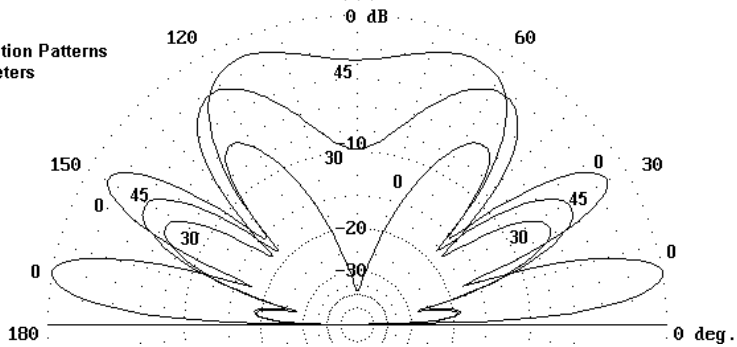

On 10 meters, we have a similar situation to the one on 15 meters. Everything is just a bit more extreme. The flat-top lobes are narrower, but at a nice low 10-degree elevation angle for DX. Unfortunately, the two Vee antennas have lost virtually all of their low-angle radiation: their lowest elevation lobes correspond to the secondary lobe from the flat-top. Hence, the DX potential of the Vees on 10 meters is somewhat dismal.

Indeed, it might be better for 10 meters to erect a simple dipole, even one that can rotate. At a 16' length, it can be hidden if need be. Its pattern is likely to be superior to either the narrow flat-top lobes of the high-angle Vee radiation. In other words, the idea of 1 antenna for everything may not be best for everyone.

## Chapter 36: About the All-Band Doublet

**T**he all-band doublet horizontal wire antenna has a history almost as long as amateur radio itself. Despite all the words and diagrams in handbooks over the years, newcomers still send me questions about the antenna. I have collected the questions and boiled them down to 10, all of which have many variations. The goal in tackling these frequently asked questions is to help newer hams erect a successful antenna system.

**1. What is an all-band doublet?** The all-band doublet is actually an antenna system and not just an antenna alone. **Fig. 1** shows the basic elements of the system. The horizontal center-fed wire forms the antenna proper, which accounts for the radiation of transmitted energy and the reception of incoming energy. The parallel transmission line transfers the energy from the antenna to the antenna tuner (or antenna-tuning unit, the ATU) or vice versa. We insert the tuner because the impedance that shows up at its terminals will vary widely from one band to another. So we need a way of matching the impedance at the tuner terminals to the standard 50-Ohm input and output impedance of the transceiver.

Fig. 1

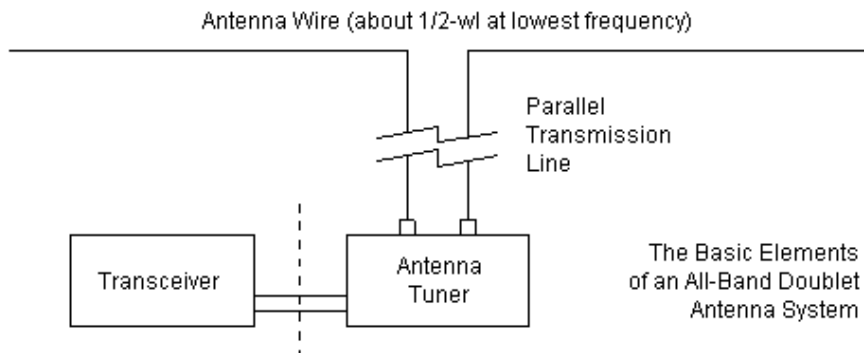

The antenna wire itself can have many lengths, but should be about  $\frac{1}{2}$  wavelength at the lowest operating frequency. **Table 1** shows common doublet lengths that have appeared in handbooks since the 1930s. It also shows the ham bands covered by the antenna. Note that the 100' wire, while somewhat shorter than  $\frac{1}{2}$  wavelength, can be pressed into service on 80 meters, and the 67' wire might be used on 60 meters. However, there are limits that we shall explore as we proceed through the questions.

Table 1. Popular lengths for all-band horizontal wire antennas

Length (feet)	HF Bands Covered
135'	80-10 meters
100'	60-10 meters (80 meters possible)
67'	40-10 meters (60 meters possible)

**2. What's the difference between a doublet and a dipole?** This interesting question has 2 answers: none and a lot. Conversationally, the term "dipole" often refers to any antenna that looks like a dipole, that is, a center-fed wire antenna with a feedline going to the shack. In this context, we also tend to call any end-fed antenna a Zepp (although there is a center-fed extended double Zepp) and to refer to any off-center-fed antenna as a Windom (although the original Windom had only a single feed wire).

In more precise terms, the coax-fed dipole that we sometimes set up for single-band use is a more complex antenna than its appearance suggests. It is actually a center-fed resonant  $\frac{1}{2}$ -wavelength dipole. The center-feedpoint is obvious from the position of the feedline. It is resonant since the feedpoint impedance is (almost) purely resistive, with little or no reactance. The length is electrically  $\frac{1}{2}$  wavelength, which for any real wire or tubular element turns out to be shorter than a physical half wavelength. Finally, it is a dipole because, as **Fig. 2** shows, the charge is minimum at the center feedpoint and maximum at the element ends. As a result, the current is maximum at the center and minimum at the wire ends. The dipole undergoes only one transition in charge and in current from the center to the wire end.<sup>1</sup>

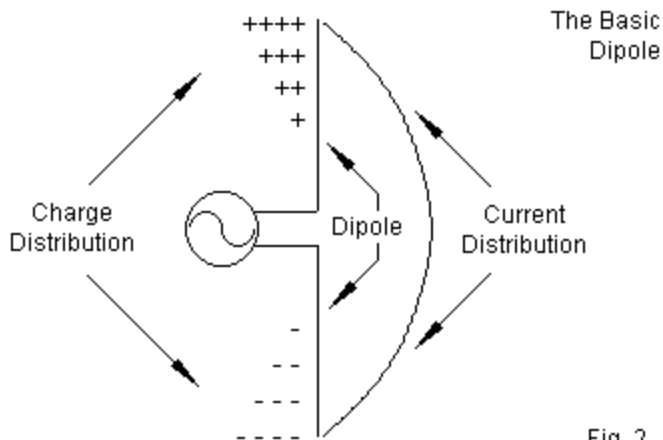
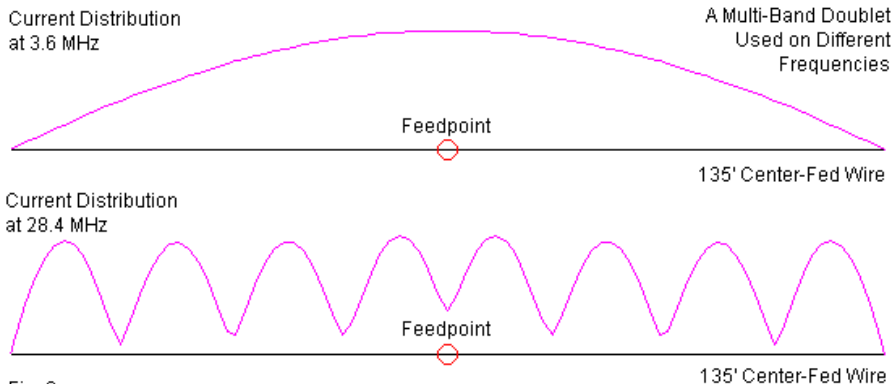

Fig. 2

When we use the antenna on many bands, it becomes electrically longer, because the length of a wave grows shorter with rising frequency. Hence, the charge and current patterns do not satisfy the dipole conditions above the lowest band or two. **Fig. 3** shows the current distribution along a 135' wire at 80 meters and at 10 meters. Since the current does not follow the dipole pattern, the charge density is also different from a dipole. In this case, there are many transitions and the current is not maximum at the center feedpoint.





The term doublet is more generic and less fully descriptive than others. However, it also has a history. In the 1930s, it served as a label for a center fed wire with a special feed system. Later, the antenna was renamed the delta feed and the term doublet became a generic term for center-fed antennas of any length.<sup>2</sup> Hence, our antenna is an all-band doublet.

**3. Do I need to measure the wire for precise resonance on the lowest band?** In a word, no. When we set up a resonant monoband dipole, we want it to achieve resonance or the lowest possible SWR with our coax cable feedline. However, the all-band doublet antenna system uses (normally) high impedance parallel transmission line. Small variations in antenna wire length will make no difference to doublet performance or to our ability to match the impedance at the shack end of the feedline. We sometimes see radiation patterns for a Yagi antenna change shape as we move

from one end of an amateur band to the other. However, the patterns produced by the all band doublet change very slowly with frequency. For example, if we only have room for 125' of wire, then it will do very well and yield the same results as a 135' wire on the lower HF bands. On the upper HF bands, we might see some change in the feedpoint impedances between the two wire lengths, but they normally will not be severe and certainly not large enough for us to abandon the antenna. The recommended lengths in **Table 1** are ballpark figures, not precise lengths.

**4. Why do I need parallel transmission line? Why not just coax? Or coax with a 4:1 balun?** To get our hands on this question, let's consider only one of the possible doublet lengths: 135'. For this version of the doublet, we can look at the numbers in **Table 2**. The second column lists the approximate feedpoint impedances for each HF amateur band. These numbers will vary with the exact length of the wire and the height above ground. However, the approximations will serve well for our demonstration.

Table 2. Line losses with coax and parallel feedlines for a 135' doublet

Frequency MHz	Approximate Impedance ( $\Omega$ )	100' RG-8X		100' 450- $\Omega$ Window Line	
		SWR	Loss (dB)	SWR	Loss (dB)
3.55	$74 + j1$	1.4	0.6	5.5	0.1
5.368	$425 + j1100$	69	7.7	9.0	0.2
7.1	$5150 - j1900$	116	11.3	14.5	0.5
10.125	$90 - j310$	6.1	6.1	7.2	0.3
14.1	$3780 + j540$	77	11.0	9.5	0.4
18.118	$125 + j15$	2.5	1.9	3.2	0.2
21.1	$2450 + j1200$	61	10.8	7.5	0.5
24.95	$125 - j170$	7.5	4.1	3.9	0.3
28.1	$1610 + j1200$	50	10.8	6.3	0.4

Suppose that we connect a typical coaxial cable to the feedpoint and use 100' of the line to reach the shack. RG-8X is popular these days because it is light and easy to handle. How much energy will we lose if we use this cable as a feedline? We can arrive at some answers by using a program like TLW. This highly useful software, written by Dean Straw, N6BV, accompanies *The ARRL Antenna Book*, which is a worthy long-term investment for any ham. In the table, columns 3 and 4 show the 50-Ohm SWR for each of the impedances and the total cable losses. Notice how many of the loss entries exceed 10 dB. With a 10-dB loss, only 1/10 of the energy at one end of the line is available for use at the other end of the line. The reduction applies whether we are transmitting or receiving.

The last 2 columns show the SWR for a 450-Ohm parallel transmission line. The type specified uses a vinyl coating with windows along the way. The vinyl coating is simply a good way to

keep the wires evenly spaced, but it does introduce losses that are slightly greater than open or true ladder line (bare wire with periodic spacers). Note that even with the highest SWR levels, losses do not exceed 0.5 dB or a little over 10% of the power, even with 100' of the line.

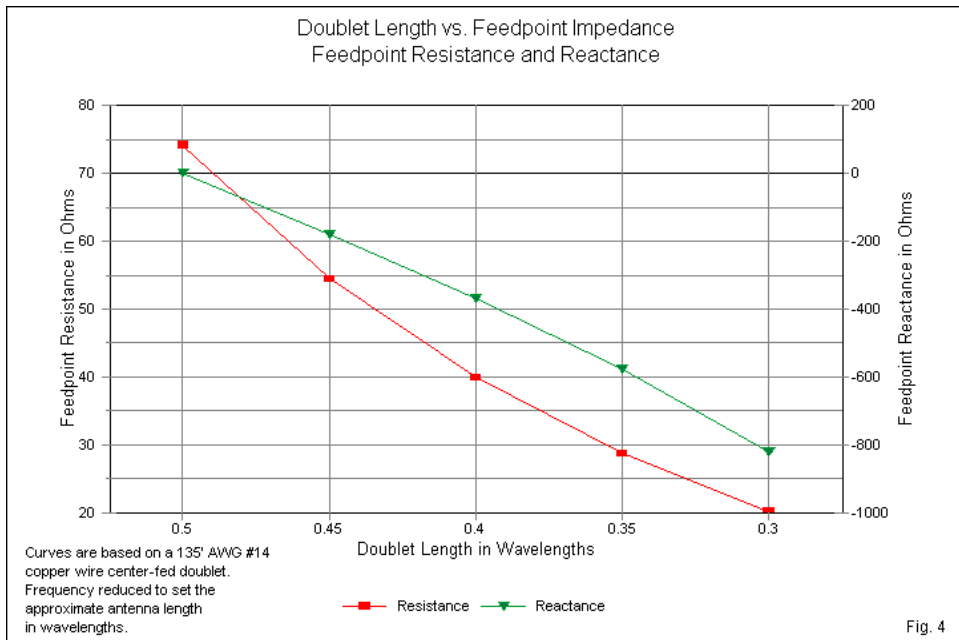

Parallel lines do have limits however. Remember that we recommended  $\frac{1}{2}$  wavelength at the lowest frequency as the shortest antenna wire length. We also suggested that we might press shorter wires into service, but we did not say how much

shorter. Let's see what happens below 80 meters as we shorten the wire from a  $\frac{1}{2}$ -wavelength starting point. **Fig. 4** shows the approximate resistance and reactance. Although the curves appear to track each other, remember that the downward path of reactance actually represents increasing capacitive reactance. As we shorten the doublet or lower the frequency, the feedpoint resistance decreases steadily, while the capacitive reactance increases steadily. The result will be a very high 450-Ohm SWR on the parallel line. It will rise to the point where even the seemingly low-loss line shows significant power losses along the way. As a practical matter, try to keep the antenna at least  $\frac{3}{8}$  wavelength or longer at the lowest frequency used if you cannot manage  $\frac{1}{2}$  wavelength. Remember that you can always zigzag the wire legs or let the ends droop downward (but always with their ends out of human reach) in order to lengthen the wire to the full  $\frac{1}{2}$  wavelength at the lowest frequency.

**5. What's the most important factor in setting up an all-band doublet? Or, we put up a low-band doublet for Field Day about 10-15' off the ground. We did not make many contacts? What was wrong?** The question's second form gives us the answer to the general question. With an all-band doublet, there is no substitute for height. However, hams must work with real conditions and not ideals.

Let's continue to use the 135' doublet as our antenna and see what happens at various antenna heights that hams actually use. 20' is a typical Field Day height for wire antennas due to the difficulty of erecting and sustaining higher supports. 40' is a nice round number

for a backyard doublet supported by mature trees. 60' is out of reach for amateurs unless they have a tower or two supporting rotatable beams. Now look at **Table 3**. It lists for each sample operating frequency the height above ground as a fraction of a wavelength.

Table 3. Doublet height in feet and as a fraction of a wavelength

Frequency MHz	Height as a Fraction of a Wavelength		
	20'	40'	60'
3.55	0.07	0.15	0.22
5.368	0.11	0.22	0.33
7.1	0.14	0.29	0.43
10.125	0.21	0.41	0.62
14.1	0.29	0.57	0.86
18.118	0.37	0.74	1.11
21.1	0.43	0.86	1.29
24.95	0.51	1.01	1.52
28.1	0.57	1.14	1.71

The height above ground when measured in terms of a wavelength is the most important factor that determines the elevation angle of a horizontal antenna's radiation. (Remember that the radiation angle is also the angle of reception sensitivity.) **Fig. 5** provides a catalog of typical elevation patterns for the doublet. Each pattern uses the headings for maximum gain as a basis. The missing bands would show elevation angles of maximum radiation that are part way between the bands in the illustration.



wavelength. 20' is a little over  $\frac{1}{2}$  wavelength on 10 meters, and so we obtain reasonable basic performance on that band.

These notes and graphics cannot change your backyard or field conditions. However, they do provide food for thought. For example, if you really want to operate on 80 and 40 meters, but cannot get the horizontal antenna high enough as a fraction of a wavelength, then you may wish to consider alternative antennas. You might achieve better performance on the lowest HF bands with a different wire antenna, such as the inverted-L.<sup>3</sup>

**6. I carefully set up my 135' doublet to be broadside to Europe. However, on 15 and 10 meters, signals are much stronger to Africa than to Europe. Is it propagation?** Although propagation affects all HF communications, the most likely source of the weak European signals is a misunderstanding of the azimuth patterns produced on the various amateur bands by the 135' doublet.

Table 4. 135' Doublet Length as a Fraction of a Wavelength and Number of Azimuth Lobes

Frequency MHz	Length $\lambda$	Number of Lobes
3.55	0.49	2
5.368	0.74	2
7.1	0.97	2
10.125	1.39	6
14.1	1.04	4
18.118	2.49	10
21.1	2.90	6
24.95	3.42	14
28.1	3.86	8



As a center-fed wire antenna grows longer in wavelengths, the number of lobes that it produces increases. **Table 4** lists the length of our 135' doublet as a function of a wavelength on each operating frequency. It also lists the number of lobes produced in the azimuth pattern, that is, around the horizon. The numbers may seem odd, but there is nothing disorderly about them. As the antenna grows longer (or we increase the operating frequency), lobes emerge, reach a peak value, and then disappear--to be replaced by other emerging lobes. Three main points describe the process. Let  $n$  be the length of the antenna rounded to full wavelengths.

1. If the antenna is  $n$  wavelengths long, then the number of lobes will be  $2n$ . On 40 meters, the antenna is about 1 wavelength, so there will be 2 lobes. At 10 meters, the antenna is about 4 wavelengths, so we shall find 8 lobes.

2. If the antenna is  $n.5$  wavelengths, we shall find the lobes for  $n$  wavelengths and the lobes for  $n+1$  wavelengths at close to equal strength. So add the number of lobes for  $n$  wavelengths and the number of lobes for  $n+1$  wavelengths to arrive at the total number of lobes. At 17 meters, the antenna is about 2.5 wavelengths. A 2-wavelength wire gives us 4 lobes and a 3-wavelength wire yields 6 lobes. So at the intermediate length, we shall find  $4+6=10$  lobes.

Table 5. Modeled Performance Data for a 135' Doublet at 40' Above Average Ground

Frequency MHz	Maximum Gain dBi	TO Angle degrees	Main Lobe Bearings degrees*
3.55	6.28	88	0/180
5.368	6.80	77	0/180
7.1	7.44	49	0/180
10.125	8.05	34	0/180
14.1	9.02	23	36/143/216/323
18.118	9.22	17	60/120/240/300
21.1	9.75	16	48/132/228/312
24.95	9.31	13	66/113/246/293
28.1	10.62	12	55/125/235/305

Note: 0° and 180° are broadside to the wire.

3. When the wire is close to  $n$  or to  $n.5$  wavelengths, the strongest lobes will be those farthest from broadside to the wire, that is, closest to in line with the wire. **Table 5** provides the modeled performance data of the 135' doublet at a height of 40' above ground. **Fig. 6** translates those numbers into a gallery of azimuth patterns. The virtual antenna runs up and down on the graph page. Because the take-off (TO) angle (or the elevation angle of maximum radiation) is so high for 80 through 40 meters, the azimuth patterns use an arbitrary elevation angle of 45°. All other patterns use the actual TO angle.

Fig. 6

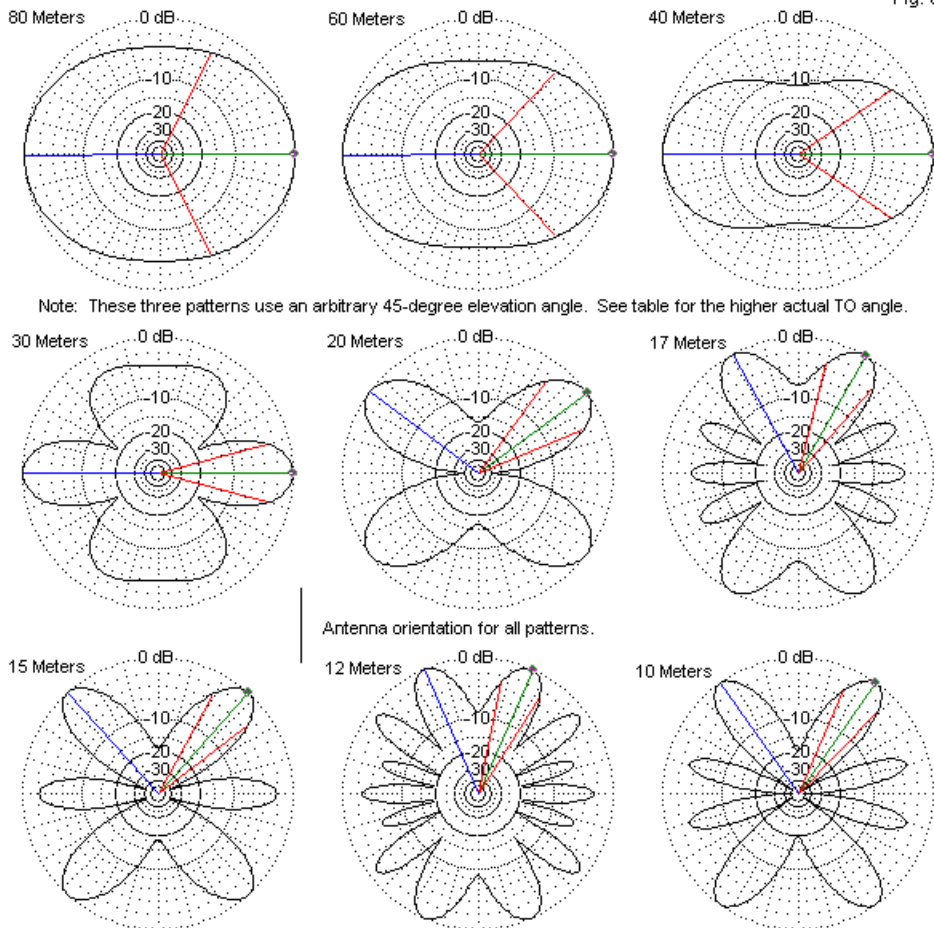

135° Doublet Azimuth Patterns with Antenna 40' Above Average Ground  
 Patterns for 80-40 meters at 45 degrees elevation. All other bands at TO angle.

Except for 30 meters, where the null between the inner lobes is hard to detect, all of the patterns clearly exhibit the number of lobes calculated in **Table 4**. Since all of the lengths are close to either a full wavelength or the half-wavelength mark between full wavelengths, the strongest lobes are those nearest to being in line with the wire. (When the wire is close to  $n.25$  or  $n.75$  wavelengths, other lobes may dominate.)

Note that when the length is  $n.5$  wavelengths, the large number of lobes in the pattern forces the strongest lobes to be closer to in line with the wire than for the next whole number of wavelengths. Hence, the angle of the lobes away from broadside is greater on 17 meters than on 15 meters--and greater on 12 meters than on 10 meters. Also note that the larger the number of lobes in a pattern, the narrower the beamwidth of each lobe.

If we had chosen a 67' doublet, the antenna would be  $\frac{1}{2}$  wavelengths on 40 meters, 1 wavelength on 20 meters, and 2 wavelengths on 10 meters. Since the azimuth lobes are functions of the wire length in wavelengths, we would obtain different lobe patterns than for the 135' wire. In fact, the 67' wire pattern on 40 would resemble the 135' pattern on 80, and the 67' 10-meter pattern would look very much like the 135' 20-meter pattern.

How you orient a center-fed doublet depends on understanding both the elevation and the azimuth patterns for the wire. The azimuth patterns show where your signal is likely to go, while the elevation patterns tell you whether the energy is likely to fall within the skip zone. Orient the doublet so that the pattern for the most

used band (or bands) covers your most desired target(s) with a strong, low-angle lobe.

So far, we have concentrated on the wire or antenna-proper portion of the all-band doublet antenna system. We briefly explored the main reason for needing to use parallel transmission lines to connect the antenna to the antenna tuner. Hams who are used to using coax often ask a number of other questions about parallel feedlines.

**7. Can I run the parallel feeders in a PVC tube underground or under my house?** This question is actually a confession by the newcomer that he or she knows how to handle coaxial cable, but not parallel feedline. In a coaxial cable, the energy fields exist between the outer surface of the inner or center conductor and the inner surface of the outer conductor, also called the braid. Hence, if the cable has an outer jacket that can handle soil, burying it does not affect its use or operation. As well, we can run the cable near to other wires without significant difficulty.

Parallel feedline is also called open-wire transmission line, and for good reason. Regardless of whether the wires have insulation, they are open in the sense of having fields that are not confined by the structure. Although the main portion of the field is between the two wires, it also extends around the pair of wires for a considerable distance--up to a few times the spacing between the wires. Nearby conductive and semi-conductive materials can disturb the balance between the lines and cause them to radiate--a job we want the antenna proper to do. As well, we may lose some energy to those

objects. So, in a nutshell, the answer to the question is no. Do not run the transmission lines close to or within the ground, even if you give them the double insulation of a conduit.

Commercially available lines come in 3 general types, each with a different characteristic impedance, construction, velocity factor (VF), and loss value. 300-Ohm transmitting twinlead, sometimes flat and sometimes tubular, has a VF of about 0.80 and a loss of about 0.17 dB per 100' at 3.5 MHz. Remember that line losses increase with frequency. 450-Ohm window line, a form of flat twinlead with cutouts to minimize the vinyl between the wires, has a velocity factor of about 0.91 and a 0.07-dB loss per 100' at 3.5 MHz, half the loss of 300-Ohm line. 600-Ohm open-wire ladder line typically has a velocity factor of about 0.92 or higher and a loss of only about 0.03 dB per 100' at 3.5 MHz. There are also commercially available ladder lines in the 400-500 Ohm range, and their VF and loss values would resemble those of the 600-Ohm line. Of the 3 types, 450-Ohm window line is perhaps the most popular for all-band doublets.

Parallel feedline has a few simple rules for effective placement to maximize energy transfer from the tuner to the antenna proper. Keep line runs as straight and in the clear as possible. Straight, clear runs are as important indoors as outdoors. Straight is self-evident. Wherever possible, keep direction changes shallow. Never let the line fold back upon itself or roll it in a coil. Clear means as far from other objects as possible, and in no case less than several times the line spacing away from anything.

Of course, we must bring the line indoors. We can use a short through-wall PVC pipe, perhaps with caps that have slots to keep the line centered. Or we can use a wood or plastic plate with feed-through insulators. The difference in spacing and bolt size on the board relative to the line is not important: it may create a small impedance bump but will minimize losses. Outdoor supports can be of two general types: rings or clamps. We can suspend non-conductive rings (slices of PVC or similar) from limbs and posts to support the line on its way to the antenna. As well, we can create non-conductive guides or clamps that extend outward from tree trunks, posts, or walls to route the transmission line. Be sure to use enough supports.

At the junction with the antenna, use a strain-relief fixture. A simple insulator may keep the line from being pulled by the antenna wire. However, over a relative short time, the feedline wires will flex back and forth until they break. A fixture that minimizes the flexing at the junction itself will make the connections much more durable.

**8. Will the feedpoint impedance in the tables appear at the antenna tuner terminals?** If the feedline is precisely a multiple of an electrical half-wavelength, then the feedpoint impedance will reappear at the far end of the line. (The other condition that would allow the feedpoint impedance to reappear is an exact match between the feedpoint impedance and the characteristic impedance of the cable. With 450-Ohm line, **Table 2** makes it clear that this condition will not exist.) When the characteristic impedance of the line does not match the feedpoint impedance, the line becomes a continuous impedance transformer and shows a different

impedance at each step between the feedpoint and each half-wavelength or  $180^\circ$  point along the line.

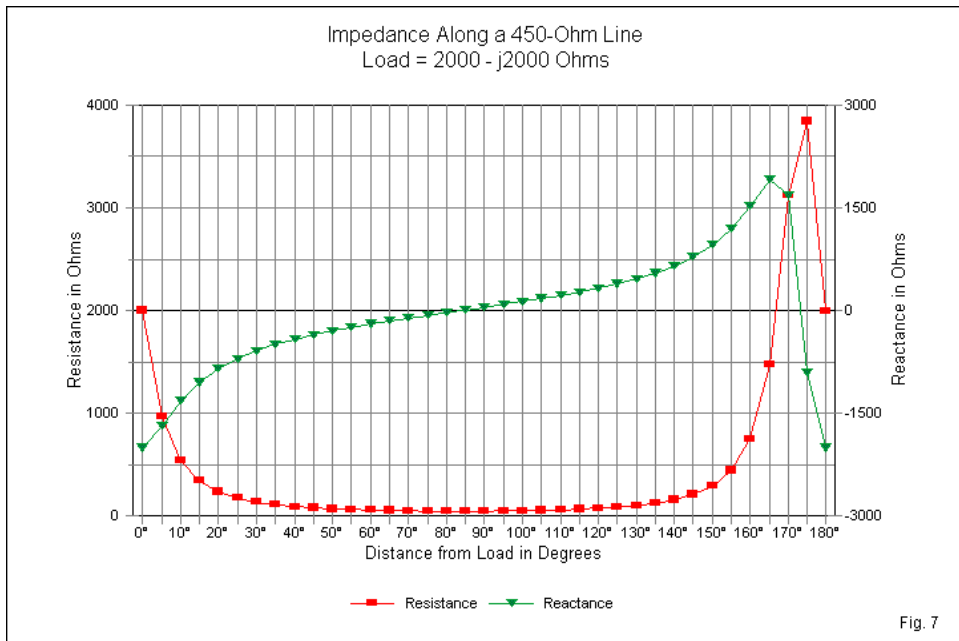
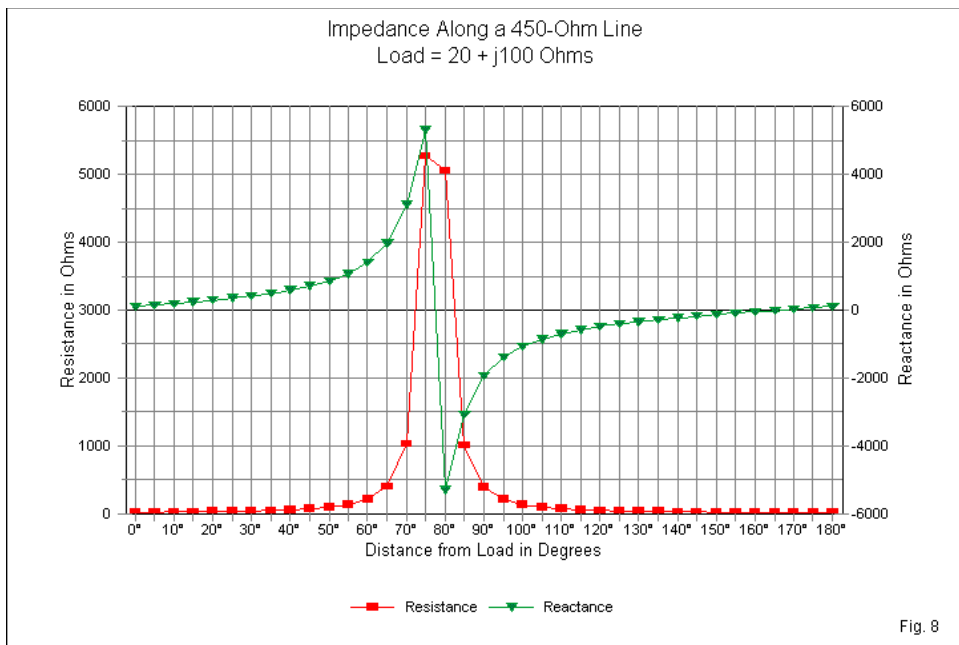

Fig. 7

**Fig. 7** shows one example of the transformation and applies to 450-Ohm transmission line and a feedpoint impedance of  $2000 - j2000$  Ohms. This impedance is similar to some values in **Table 2**. If the reactance had been inductive instead of capacitive, we would see similar curves, but the peaks would appear at  $10$ - $15^\circ$  position along the line (where  $0^\circ$  is the antenna feedpoint and  $180^\circ$  is a half-wavelength down the line). Note the very low resistance and the



relatively low reactance that appear over much of the line's length. For this reason, placing a 4:1 balun in the line may be a poor choice for converting the balanced line to a single-ended or unbalanced line. The transformer may end up converting a low impedance to a very low impedance, regardless of the balun's ability to handle the reactance at its terminals.



Let's change the feedpoint impedance to  $20 + j100$  Ohms. Some impedances for very short doublets (less than about  $3/8$  wavelength) show a higher reactance (capacitive), but the peaks

become very high and the resistance becomes very low--a very difficult situation to graph. **Fig. 8** graphs the resistance and reactance of the selected values along the line. Note that the peaks occur just before the 90° or halfway position. If the reactance had been capacitive, the same peaks would appear just past the halfway point along each half wavelength of transmission line. Once more, note for how much of the line the resistance and reactance are low to very low.

The two samples show some of the extremes of impedance transformation along a 450-Ω transmission line. The closer the feedpoint impedance is to the line's characteristic impedance, the less radical will be the transformation of resistance and reactance. It pays to have a small calculation program to assist in finding and visualizing the data. Earlier, I mentioned the N6BV program, TLW. You can obtain similar graphs on it. In addition, the graphs will show the effects of line losses.

The graphs show an electrical half wavelength of line. The physical length of such a line will vary with the operating frequency. Hence, it is very difficult (although not impossible) to design a feedline system so that on each band we end up with just about the same impedance at the shack entry. Most amateurs let the antenna tuner do the work of transforming whatever impedance appears at the terminals to the transceiver's required 50 Ohms.

### **9. What kind of antenna tuner is best for an all-band doublet?**

The best type of antenna tuner is one with a configuration that naturally has an unbalanced or single-ended input--to accept the

transceiver's coaxial cable--and a balanced output. From the earliest days of amateur radio, a common tuner meeting these conditions has been the link-coupled tuner. **Fig. 9** provides a simplified schematic diagram of one version of this tuner. It received its name because the input side used a small coil or link that is inductively coupled to the tank or parallel tuned circuit on the output side. The most effective forms of this tuner used additional components on the output side to compensate for the reactance at the terminals. Taps at every turn (or at least at every other turn) of the tank coil allowed the user to find a setting that came closest to providing a good match and maximum power transfer at the same time. The link might also have switched taps with the later addition of the so-called variable coupling series capacitor. In fact, the series capacitor compensates for remnant reactance on the input side, allowing a purely resistive input impedance. Johnson Matchboxes, with simplified tank tapping, a fixed link, and no series input-side capacitor, became famous and still appear at hamfests.

Fig. 9

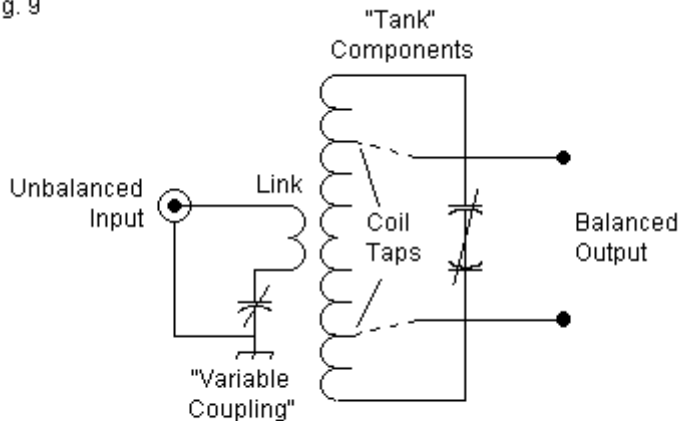

One Version of a Libk-Coupled HF Antenna Tuner

From the late 1960s onward, the single-ended network came to rule the commercial manufacture of antenna tuners. **Fig. 10** shows 4 popular configurations, with the CLC-T being the most common. It was perhaps the cheapest to produce in a period of rapidly rising component costs. It would also handle a very wide range of impedances at the output terminals. However, the CLC-T was a high-pass filter network and hence provided little harmonic suppression for older rigs. Like all of the single-ended configurations, it required a balun on the output to allow for balanced lines. The standard version of the balun used a 4:1 impedance ratio either through a misunderstanding of the impedances likely to be present at the terminals or because such baluns were cheaper to make than 1:1 baluns. The baluns were

transmission-line transformers that are most efficient when the reactance is very low. Most balanced lines, however, did not meet this condition. The average operator did not have multiple tuners to compare and so remained unaware that on some bands with some tuners, efficient power transfer might not occur.

Fig. 10

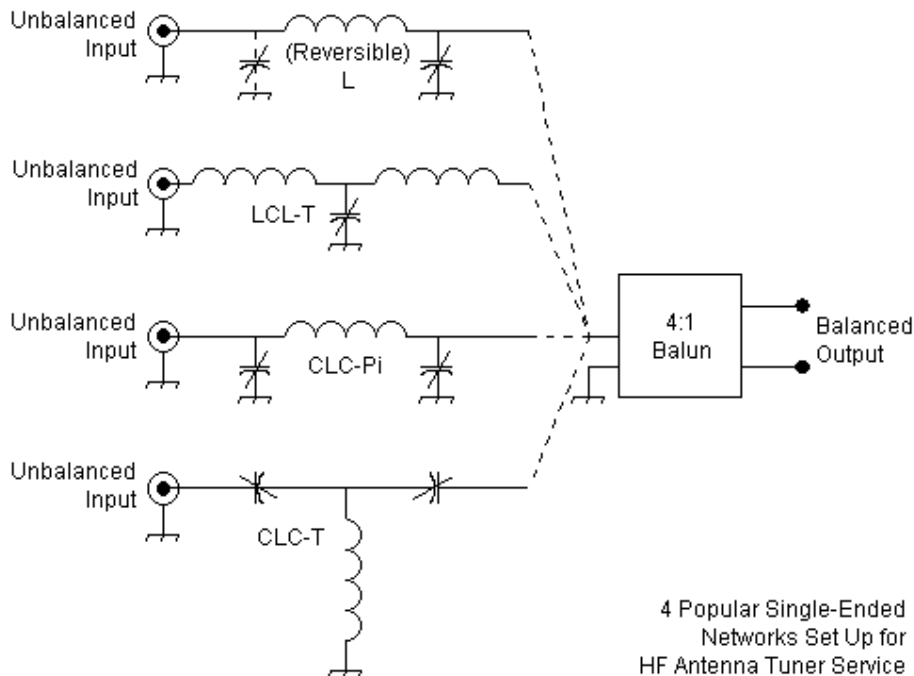

In recent years, interest in antennas that require parallel transmission lines has surged, spurring the development of new inherently balanced tuners. **Fig. 11** shows three varieties that are either on the market or in handbooks. The single-ended CLC-T network is usable with special precautions not to ground any component except the transceiver side of the 1:1 input balun that is common to all of the tuner designs. One commercial tuner uses a balanced CLC-T network, but the most common balanced network tuner on the market is the reversible-L circuit. Versions exist for high power use. However, as the operating frequency increases, the range of impedances that the reversible-L will match with standard components grows more limited.

Fig. 11

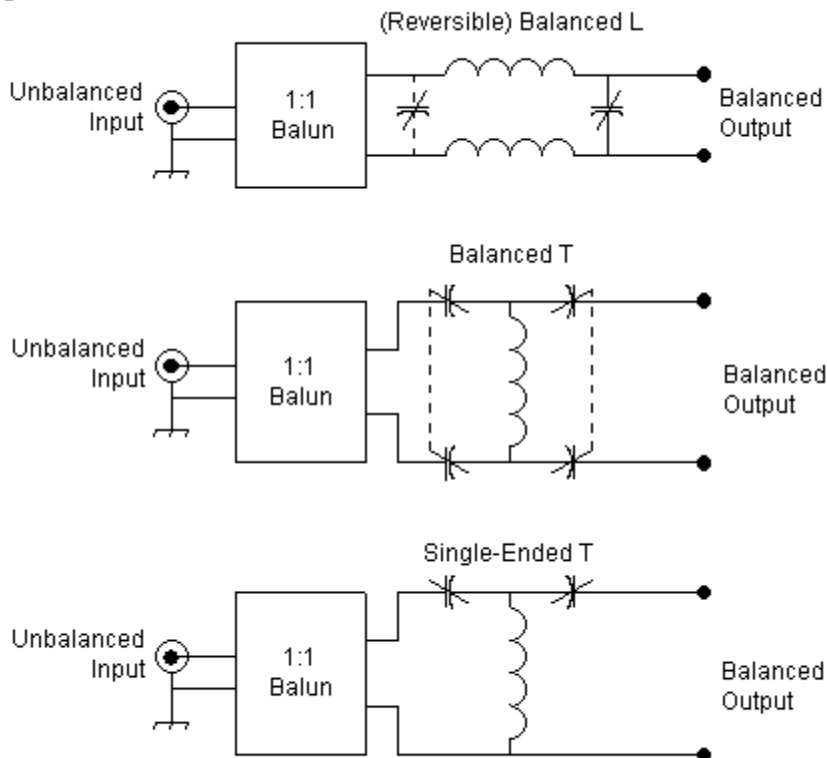

3 Popular Networks Used for Balanced HF Antenna Tuners

If you will buy a tuner with an all-band doublet in mind, then one of the balanced network tuners may be the best bet. However, if you already have a tuner--even a single-ended network with a 4:1 balun

on the output side--you might as well try it out. Since none of the tuners comes with a relative output indicator, you will have to estimate efficiency on each band indirectly. If you obtain a good match following the maker's suggestions for the best component settings, check the temperature of the balun after (not during) operation. If the balun is warm to the touch, it likely is converting some part of your transmitted energy into heat. In general, the broader the tuning, the lower the tuner losses, although there are exceptions to this rule of thumb. In a tuner designed for all of the HF ham bands, tuning will naturally become sharper with rising frequency.

If you cannot obtain a match on a given band, then try inserting a length of transmission line, preferably outdoors. Using knife switches, relays, or a simple manual changeover, add a few feet of line between the line ends of a break that you intentionally make in the feeders. Form the insertion into a single large loop to avoid unwanted self-coupling, and use standard precautions to prevent coupling to other objects. Since the transmission line is a continuous impedance transformer, the new values of resistance and reactance at the tuner terminals may fall within the tuner's range. Since every tuner has a limit to the range of resistance-reactance combinations that it will handle, the potential need for a revision in the total feedline length may apply to all antenna tuner designs.

**10. My all-band doublet is 50' high and uses open-wire feeders. It works well, but I get a lot of RF interference at home, and my rig sometimes locks up in transmit on CW. How can I**



**overcome these problems?** Unwanted coupling into home electronics and into the rig itself has almost as many causes as there are errors that we may make in installing parallel feedlines. The first step is to ensure that all station equipment is well grounded to an earth ground as close to the rig as may be feasible. The second step is to consider rearranging the station so that you position the antenna tuner at the place where the feedline enters the building or shack. Well-grounded coax braid is less likely to couple RF energy to other lines and objects than open-wire transmission line.

The third step is to check the routing of the transmission line as it approaches the entry point. Ideally, the line should approach the entry perpendicular to the wall or window. If the line runs vertically down a wall, it may couple energy into various power, telephone, or computer lines. Some of these lines may use shielded cable, but unless that cable is also well grounded, it may carry RF energy to sensitive devices with equally poor grounds.

Sensitive devices, including control inputs for the rig, do not require very much energy to show signs of interference. If all else fails, you can try the system shown in **Fig. 12**. At the building or shack entry, install a 1:1 choke of ferrite beads, following the designs of W2DU. The choke acts as a balun, converting the balanced line to the unbalanced coax. From the coax connector shell, run a very short earth-ground line. Ideally, the choke should go outdoors, but modern building construction may require immediate indoor installation at the entry point. Between the choke and a single-

ended network tuner, run less than 20' of the largest, lowest-loss coax that you can obtain.

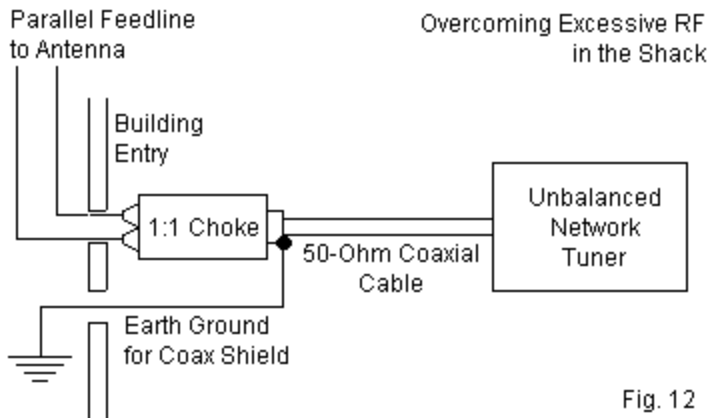

Fig. 12

The system shown will generally eliminate most unwanted RF energy transfers if the feeders have not already coupled into house wiring due to improper dress. It bypasses the 4:1 balun in the tuner, avoiding that loss source. However, the system has losses of its own. The 1:1 choke will show losses with high impedances having significant reactive components. The coax will also show some loss. However, if the length is 20', the line losses will usually be fairly small. For example, at 30 MHz, 20' of RG-213 will show a 1.1-dB loss with a 10:1 SWR. A shorter run, lower frequency, or lower SWR will result in lower coax losses. There are also cables with even lower losses. Do not use thin cables like RG-58 for this run, regardless of the operating power level. This system is not ideal,

but simply a measure of last resort for very tough cases of RF interference. Before employing this or other radical systems, you should first use the earlier guidelines to optimize the feeder and tuner installation.

These notes do not answer every question that we can ask about the all-band doublet. However, I hope the 10 common questions that we have tackled give you a good start for reasoning out answers for yourself.

## Notes

1. **Fig. 2** follows Stutzman and Thiele, *Antenna Theory and Design*, 2nd Ed. (Wiley & Sons, 1998), p.57, although the treatment of the dipole in very short or longer forms is similar in Kraus and in Balanis. (Kraus, especially, (*Antennas*, 2nd Ed.) is careful not to label longer center-fed wire antennas as dipoles).
2. Compare, for example, 2 editions of *The Radio Amateur's Handbook*: the 13th or 1936 edition, p. 278, and the 24th or 1947 edition, p. 207.
3. The inverted-L is a highly usable antenna for general-purpose communication, but requires an entirely different discussion. See "Straightening Out the Inverted-L" in the *2005 Proceedings of FDIM*, produced by QRP ARCI.

### Chapter 37: The Zig-Zag Dipole-Doublet

One over-age myth about wire antennas is that they must be straight. Ideally, we would like them to be truly linear. However, even a kinky wire can perform quite well.

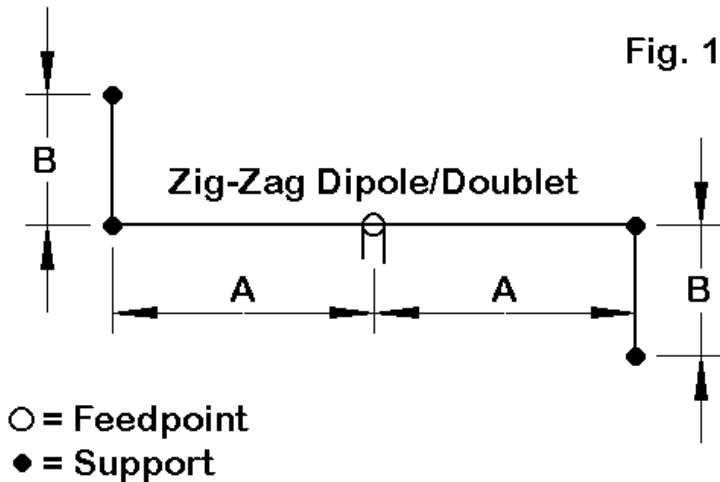
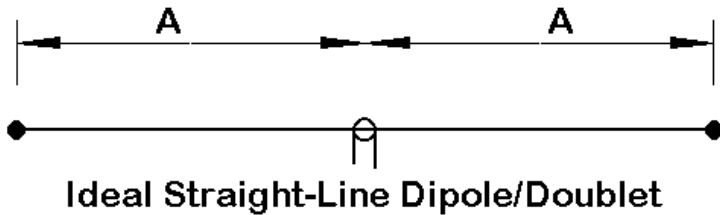

Consider the scenario sketched in **Fig. 1**. A standard 1/2 wl dipole for 80 meters--about 135' long when about 50' up--would look like the upper sketch if we had the room for a 67.5' long wire runs on each side of the feedpoint. However, suppose that we do not have the room for the full length of the wires. We can settle for a shorter wire antenna, but we do have another option if supports are available: the zig-zag special. What we did with dimension A in the top drawing, we shall now do with A + B in the lower drawing.

The antenna could have been made into a U, but the loss of gain would have been slightly higher than with the zig-zag--due to the partial cancellation of the radiation from the facing end sections. However, the amount is small enough that, if a U is all that you can manage on a site, "U"se it.

To see what happens when we zig-zag our traditional dipole I ran a series of models, each of #12 copper wire over average soil. Modeling is limited in that it assumes clear, level terrain, and so it cannot take into account the hills, valleys, and ground clutter of the typical ham installation. Nonetheless, the trends are quite useful for comparative purposes.

If the antenna is set 50' up, the typical dipole pattern at an elevation angle of about 20 degrees is an oval at right angles to the wire. Let's see what happens as we turn more and more of the antenna into opposing end pieces. For the example, I used 5% increments of the half length, thus shortening each side of center by 3 3/8' with each move. Theoretically, the end piece should grow by that amount to keep the antenna resonant. Actually, we shall have to

lengthen the ends slightly with each change in order to compensate for coupling between the wires near the corners.

The following table lists the wire lengths each side of center (A) with both the calculated and actual end pieces (B) need to restore resonance at 3.5 MHz. The feedpoint resistive impedance at resonance is also shown, along with the maximum gain. The final figure is the number of degrees off broadside that the pattern tilts as a result of the zig-zag ends.

End (B) %	Calc. Feet	Act. feet	Length A feet	Gain dBi	Pat. Tilt degrees	Feed R Ohms
0	0	0	67.5	0.06	0	70.0
5	3.4	3.7	64.2	0.06	0	67.6
10	6.8	7.3	60.8	0.04	1	66.4
15	10.1	11.0	57.4	0.02	1	64.9
20	13.5	14.5	54.0	-0.01	2	62.3
25	16.9	18.2	50.6	-0.05	2	59.7
30	20.3	21.7	47.3	-0.09	5	56.2

The total loss in gain within the situation set up is 0.15 dB for the entire spread from a linear wire to an antenna with 30% of each side turned at right angles to the main wire. If the zig-zag happens to be more open than the right angle used in the example as an extreme case, the loss will be less. However, it is already so low as to be undetectable in operation.

Had we bent the ends to form a U, the gain in the most extreme case would have been very slightly lower than for the zig-zag dipole, and so too would have been the source resistance at resonance. Another comparison of note is between the 20% zig-zag model and a wire 108' long and linear--something close to the

traditional G5RV length. The G5RV would have shown about 0.1 dB less gain than the zig-zag, which would have been far less operationally significant than the high capacitive reactance at the feedpoint. However, if we feed the antenna with parallel feedline and an antenna tuner, all of these differences fall among the trivial.

The greater the amount of antenna devoted to the zig-zag ends, the longer the wire must be to restore resonance. Again, a more open zig-zag will show smaller amounts of required lengthening. Likewise, the feedpoint resistance goes down more rapidly as the zig-zag becomes more extreme.

The amount of pattern tilt is very mild, even at the 30% zig-zag mark. **Fig. 2** below shows an overlay of the straight wire and the zig-zag azimuth patterns for the 20-degree elevation angle. Again, in real operation, the difference will be unnoticeable. Notice that the pattern tilt is away from the bent ends.

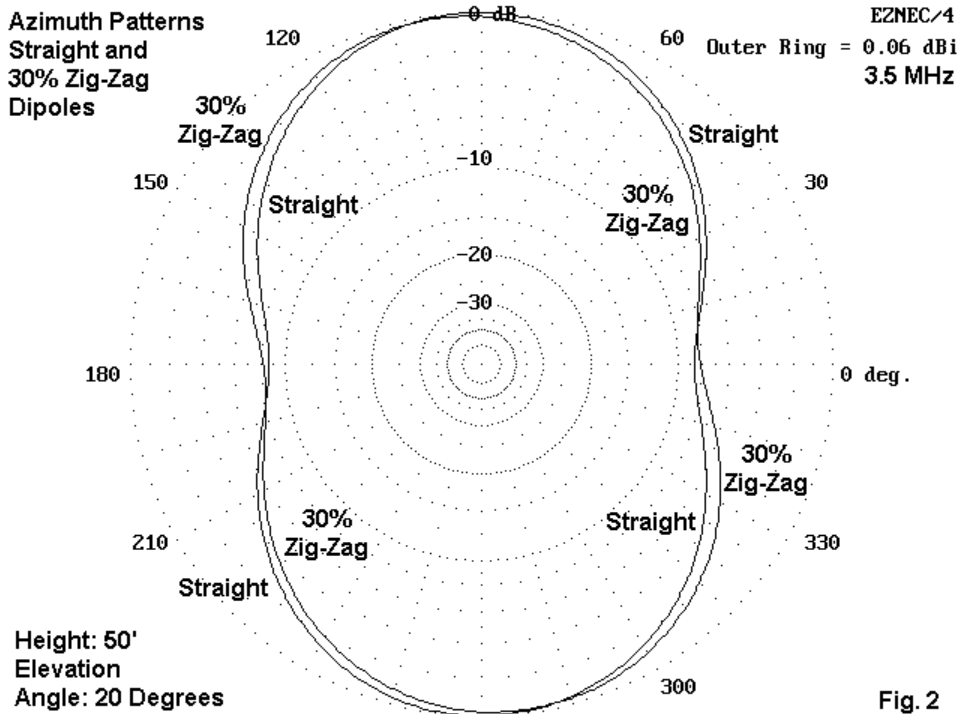

As the zig-zag involves more than 30% of the wire on each side of center, the pattern tilt becomes more extreme, exceeding 10 degrees as the lengths A and B approach each other. We can view this amount of tilt as a disadvantage, or we can put it to use. Suppose the main supports we have will place the broadside pattern some 10 degrees off target for our desired operation. Making the antenna into a zig-zag dipole can put us back on target.



## The Dipole Becomes a Doublet

If we choose to use the zig-zag on other HF bands, what happens?

The first thing that happens is that the antenna is no longer a dipole. A dipole is an antenna with a single current maximum at its center and voltage maxima at its ends. It is a center-fed dipole in the version with which we are working. However, since its length will no longer be apt to produce the current and voltage conditions along its length once we increase the frequency of operation, it will no longer be a dipole. Typically, a multi-band single (simple) wire is best termed a "doublet," a term that implies nothing in itself about the current and voltage distribution along the length.

The second thing that happens is this: the exact length is no longer of great consequence. Our first tests intentionally strove for resonance at 3.5 MHz in order to see what happened to the length of the end pieces. In multi-band use with parallel feeders and an antenna tuner, the length is no longer critical. The patterns will not significantly change with up to 5% differences in overall length, and antenna resonance is no longer a serious consideration.

A third phenomena is the variation of the patterns of lobes and nulls from those that we are used to associating with a straight-wire doublet. To see what happens, let's use 40, 20, 15, and 10 meters as test bands to compare the patterns of a straight-wire doublet and our 30% zig-zag doublet--both of #12 copper wire 50' up. Of course, if we use a smaller amount of zig-zagging, then any

deviations of patterns from the normal doublet pattern will be that much less.

In each of the patterns shown below, the antenna extends from one side of the pattern to the other. The zig-zag legs bend downward (relative to the page) on the left and upward on the right. Hence, most of the pattern tilting will be to the upper left corner of the page, at least at lower frequencies.

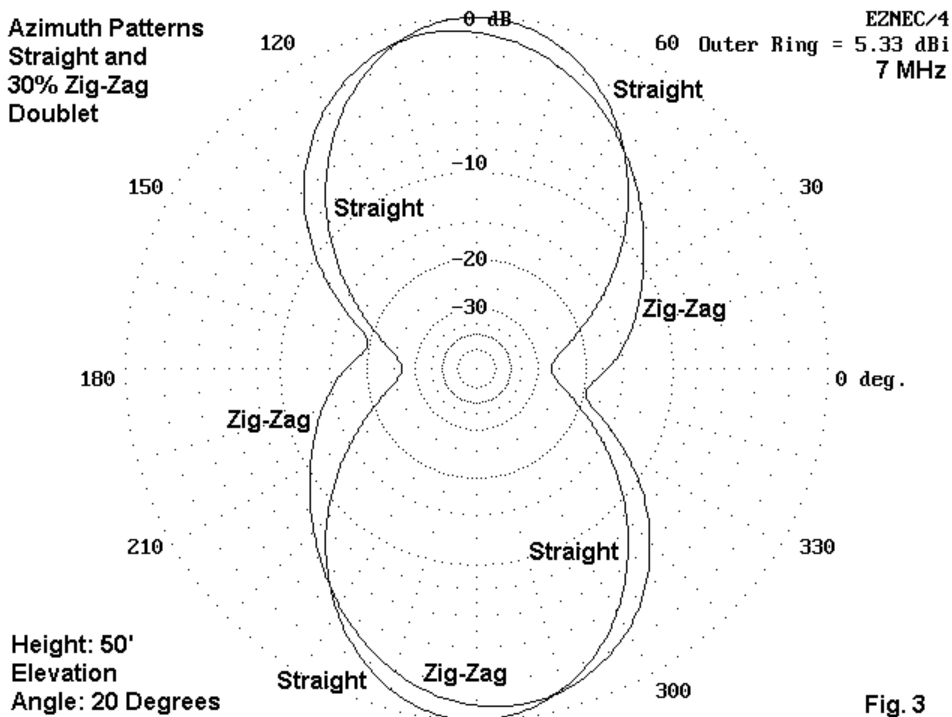

At 7.0 MHz, the zig-zag pattern shows a 5-degree tilt relative to the broadside lobes of the normal doublet. The elevation angle of maximum radiation is still very high, so a 20-degree elevation angle has been selected for the comparison to reflect something approximating normal skip angles. The gain of the zig-zag is slightly less (by about 0.5 dB) than that of the straight wire and is accompanied by a broadening of the beamwidth in both directions. Since the antenna is about  $1 \text{ wl}$  long, the feedpoint impedance is very high. The zig-zag side nulls are shallower than those of the normal doublet. However, none of these differences are likely to result in any gained or lost contacts.

Azimuth Patterns  
Straight and  
30% Zig-Zag  
Doublet

EZNEC/4  
Outer Ring = 9.33 dBi  
14 MHz

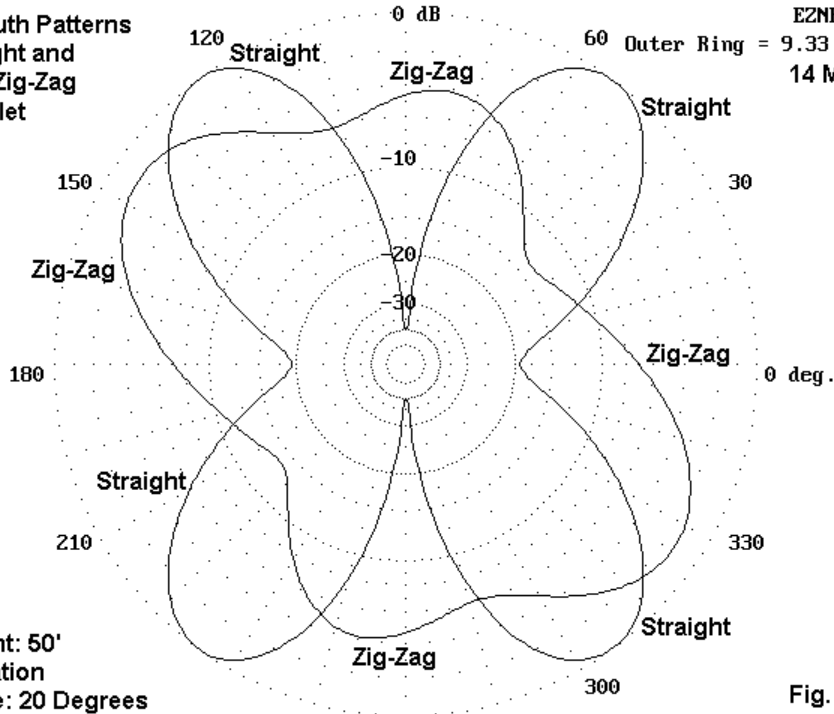
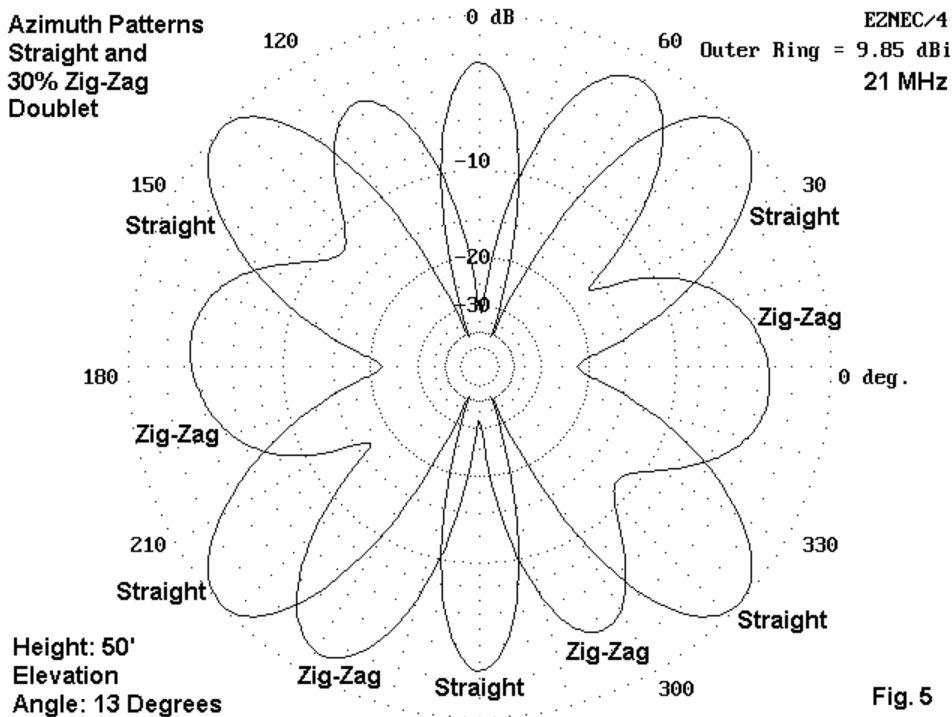

Fig. 4

Lest we simply presume that the remaining HF bands will show essentially similar parallels between the straight and the zig-zag doublets, operation of the antennas at 14.0 MHz serves as a reminder that difference might emerge at any frequency. The elevation angle of maximum radiation on 20 meters is 20 degrees with the antenna at the 50' mark. Hence, the patterns show the maximum gain of the antenna. The straight-wire doublet shows the familiar 4-leaf clover pattern typical of a wire 2 wl long.

In contrast, the zig-zag antenna shows much greater tilt, with the peaks being about 20 degrees distant from those of the normal doublet. The nulls are just barely perceptible, but with that improved coverage comes a price: the lobes are weaker than those of the normal doublet by about 1.3 dB.



At 21 MHz, the normal and the zig-zag patterns almost oppose each other, with zig-zag lobes filling normal nulls and vice versa.

Once more, the normal doublet shows a higher maximum gain (by about 1 dB), but the zig-zag doublet tends to have shallower nulls.

Part of the reason for the especially strong zig-zag lobes off the ends of the antenna is that each bent section of the zig-zag is approximately  $1/2 \text{ wl}$  long at 15 meters. Had the zig-zag "B" length been shortened, the end radiation would have decreased rapidly. When operating the antenna at multiples of its initial frequency, the current magnitude shows a number of peaks, and the geometric configuration plays an increasingly significant role on the ultimate azimuth pattern generated.

Azimuth Patterns  
Straight and  
30% Zig-Zag  
Doublet

EZNEC/4  
Outer Ring = 10.84 dBi  
28 MHz

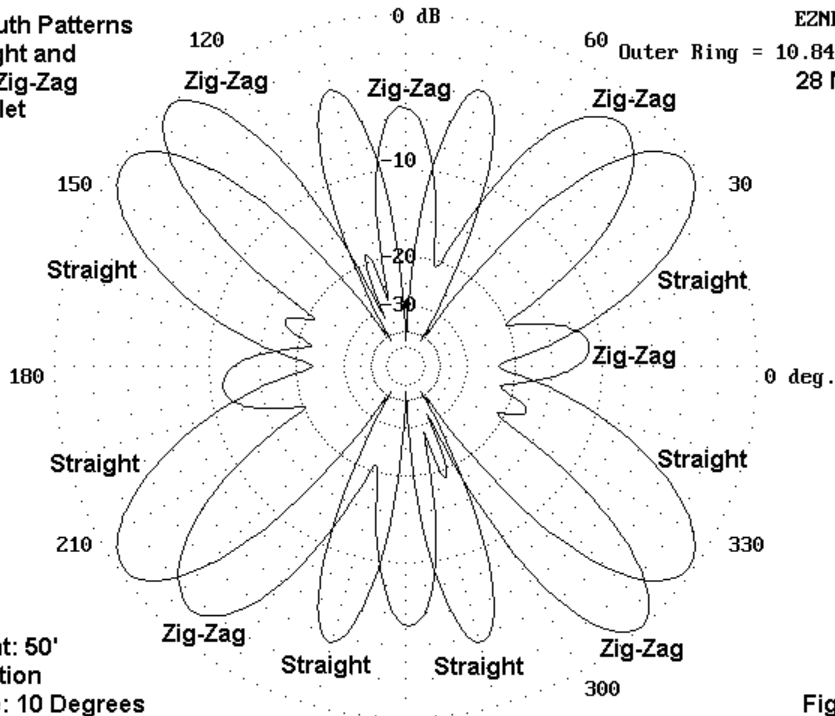

On 10 meters, at 28 MHz, there are so many lobes that the difference in the two patterns becomes less significant operationally. In fact, there is no significant difference in the strength of the largest lobes of the two antennas. However, we may note the two small lobes off the end of the zig-zag antenna. Because the end of "B" lengths are no longer close to  $1/2$  wavelength long, they develop lesser lobes. Some of the versions of the zig-zag with

shorter "B" dimensions might well show stronger radiation off the antenna ends.

The feedpoint impedance of both antennas at the even harmonics of the original  $1/2 \text{ wl}$  frequency of the antenna will be high. The exact figures will be functions of the antenna's exact length. At harmonics, effects of the zig-zag will vary slightly from band to band, and hence the feedpoint impedances will not be identical to those of the straight wire. Values of resistance in the 1,000 to 4,000 Ohm range and values of reactance from 500 to 1200 Ohms are likely to be common for both the straight-wire and the zig-zag doublets. What values appear at the antenna tuner terminals will depend not only on these load values, but as well on the characteristics and length of the feedline used. If a tuner cannot handle the values presented on a certain band, insertion of a short length of additional feedline will usually correct the situation.

## Other Variations

We have already noted that when the ends of the antenna are bent in the same horizontal direction, the resulting U-shaped antenna is only a tiny bit lower in gain than the 30% zig-zag. A more common scenario is to droop both ends downward. At the fundamental frequency, this configuration tends to lower gain still further, since the ends are closer to the ground. However, the result is far from disastrous. At higher frequencies of operation, the ends may show significant vertically polarized radiation, but the net effect will not be sufficient to alter the basic horizontally polarized patterns for each band.

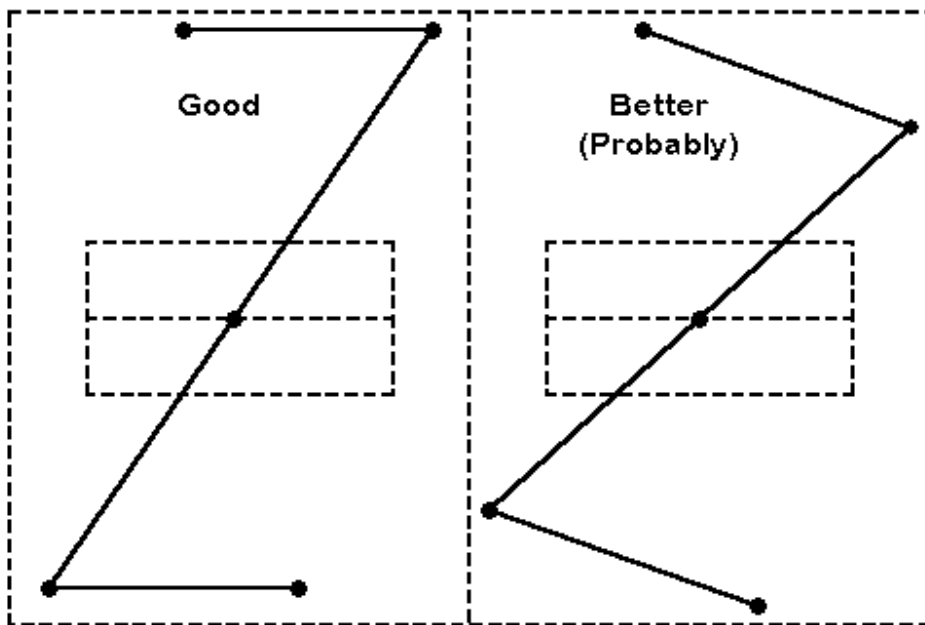

Fig. 7

**Two Configurations of a 135' Doublet: Zig-Zagged**

Perhaps the ultimate utility of the zig-zag doublet is to fit a full 80-meter length into a fairly restricted yard size, as suggested in **Fig. 7**. running the antenna diagonally across the yard for the available space and then tilting the wires back along the yard lines (assuming supports are available) can make a multi-band doublet available to almost anyone.

The principle can also be applied to hidden roof-top or attic antennas. The ends can be run along the rafters and roof trusses, if appropriate care is taken to give clearance to conductive materials.

The urban dweller can still operate effectively even if circumstance seems to dictate undersized antennas. The key is to think in designer shapes, of which the zig-zag is a perennial winner. The losses, compared to traditional straight-line designs, may be far smaller than initially imagined.

## Chapter 38: The Y-Doublet

**A**fter presenting some notes on triangles of doublets of various lengths, I received more than one message recalling an old Y-configuration from the 30s and 40s. The basic scheme was designed for a given band and consisted of three 1/4-wavelength wires at 120-degree angles coming together at a center point. There, according to recollections, the old timers used a 3-wire twisted feedline to the shack. At any one time, the operator hooked up two of the 3 wires to the antenna tuner (or, in more remote past times, to the rig output terminals). The result was a steerable doublet.

Essentially, the operator was selecting the pair of feed wires that created a doublet, with the third antenna wire relatively inert. We normally think of a doublet as linear, but bending it by 30 degrees does not especially harm its performance. So that part of the system is quite sound.

More foreign to current practice is the twisted feedline. In the 1930s, many hams commonly feed their dipoles with low-impedance parallel line. A 72-Ohm transmitting parallel line used to be available, but apparently the high power version is no longer made. 72-Ohm parallel lines made from round wires are not feasible with open-wire construction, since the required center-to-center spacing would require contact between the wires. However, by using a carefully calculated thickness of an insulating material with a known dielectric constant on each wire, the desired impedance is achievable.

Amateur practice tended to rely on two factors. First, the resulting parallel line resembled ordinary line cord, sometimes called zip cord. Second, properly configured antenna tuners or even amplifier output circuits were capable of handling a fairly wide range on impedances. Therefore, amateurs used to simply twist pairs of insulated wires together to form a low impedance parallel feedline. The wires might be line cord or they might be other insulated wires twisted and taped together.

Adding a third wire to the set and leaving it disconnected from the RF source was relatively harmless. If the wire was equally spaced from the other two hot wires, it would have negligible current on it. The antenna wire would be at essentially right angles to the main pattern and hence induce a minimum of coupled antenna current into the inert feeder. Since the currents on the other two feeder wires would be equal in magnitude but opposite in phase, any induced currents in the third wire would cancel, leaving no current in the third wire.

Overall, the system effects a space savings over three doublets in a triangle. With good solid AWG #12 wire for the elements, one can use only three corner supports and let the triangle of antenna wires support the center assembly. (One can always add a center support, if convenient or necessary.) With that promise and the potential for having a steerable doublet, the idea is worth further exploration.

## The Steerable Y-Doublet Array

Let's begin by looking at the antenna wires and their potential performance. We shall look more closely at the feed system later on. The basic configuration of the Y-doublet appears in **Fig. 1**.

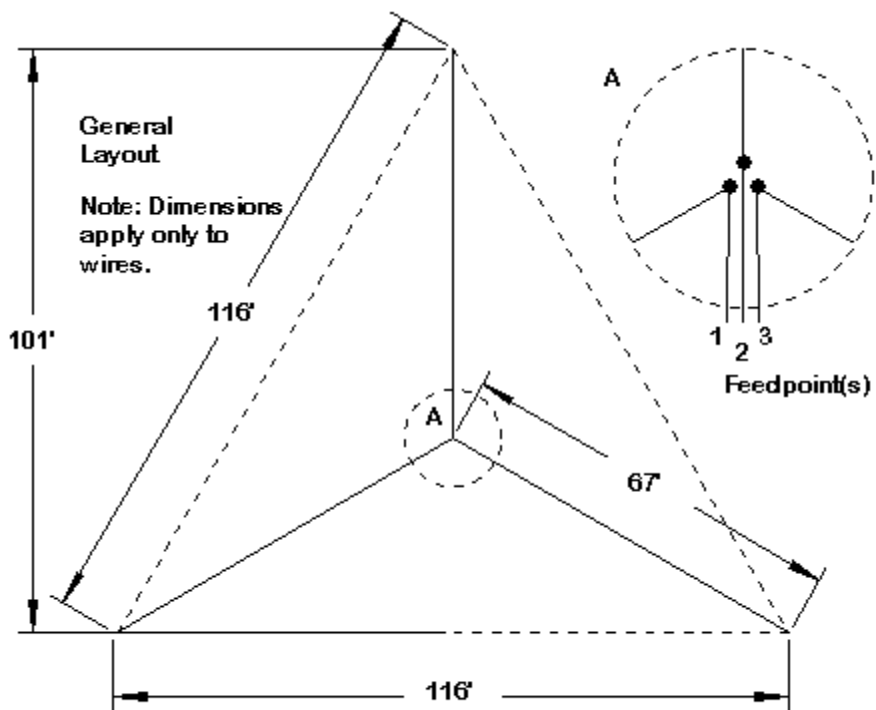

General Outlines of a Y-Doublet System

Fig. 1

We shall use as our test array a Y cut for 3.6 MHz. My free-space model used 67' legs for initial checks. Hence, ignoring the necessary insulating end ropes to the support trees or posts, we get a triangle about 116' on a side and capable of fitting within a rectangular back yard that is about 101' by 116'. The figure shows the three feed wires, of which we shall use only two at a time. For modeling, that means terminating each leg short of the exact center point. Then we connect a short wire between 2 of the 3 wires. I used a separation between inner leg ends of about 3' so that I could use a 3-segment wire for the source and use segment lengths of about 1' on the antenna wire legs.

**Y-Doublet Azimuth  
Patterns**

**Fig. 2**

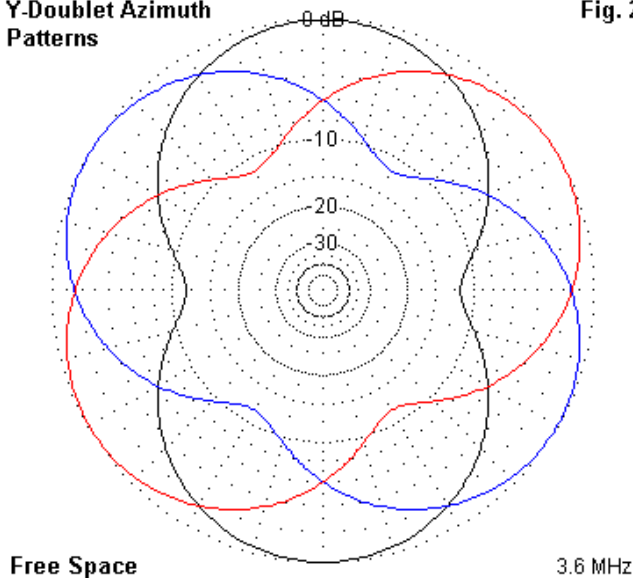

**Fig. 2** shows the overlaid free-space patterns for the Y-doublet at 3.6 MHz using different pairs of legs to form each of 3 doublets. The patterns indeed promise full horizon coverage as we switch pairs of feedlines at the shack end of the feeder lines.

I also checked the antenna's performance on each of the bands above 80 meters. All of the traditional ham bands (40, 20, 15, and 10 meters) yielded very high feedpoint impedances. Since we are working with a low-impedance feedline, I set these bands aside as not especially feasible for use with the system. (We shall review this decision before we are finished.) However, 30, 17, and 12 meters showed feedpoint impedances sufficiently low to potentially allow use of the antenna on these bands using the low-impedance feeder system employed in first half of the 20th century. The following table shows the free space performance potential of the array.

.....  
 Y-Doublet Modeled Performance: Free Space

Freq. MHz	Gain dBi	Feed Z R+/-jX Ohms
3.6	1.70	59 - j 6
10.125	5.16	106 - j 375
18.118	4.62	134 - j 103
24.94	4.92	171 - j 291

.....

The free-space patterns are generally only applicable for a real horizontal antenna over ground if the height is at least 1 wavelength. 80-meter doublets at 270' or more are rare. Therefore, I remodeled the antenna at a 50' height to reflect a more realistic

scenario. At that height, the maximum gain of the antenna has an elevation angle that is nearly straight up. So I chose for that band an angle of 34 degrees to reflect typical skip angles. The resulting 3.6-MHz patterns, shown in **Fig. 3**, are a good bit more oval than their free-space counterparts.

**Y-Doublet Azimuth  
Patterns**

**Fig. 3**

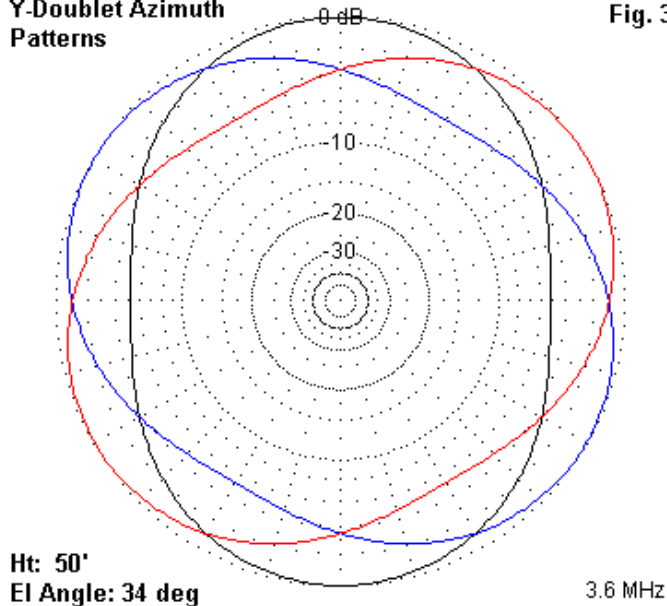

On the upper bands, I used the take-off (TO) angle for gathering potential performance data. The antenna promises performance as shown in the following table, with the leg-length adjusted to 66.5' to bring the array close to resonance at 3.6 MHz. (Wire doublets tend



to vary their feedpoint impedances with height in noticeable ways when the doublet is less than 1 wavelength above ground.)

.....  
 Y-Doublet Modeled Performance: 50' Above Average Ground

Freq.	Gain	TO Angle	Feed Z
MHz	dBi	degrees	R+/-jX Ohms
3.6	3.43	34*	56 + j 8
10.125	9.98	26	110 - j 424
18.118	9.59	14	135 - j 153
24.94	10.23	11	182 - j 365

\* 80-meter elevation angle arbitrary.  
 .....

The patterns on the upper bands are not ovals by any means. **Fig. 4** shows these patterns, but only one pattern per band for clarity. As we increase frequency, we find two especially interesting pattern properties. First, as the legs become longer in terms of wavelengths, the patterns develop growing side "wings." Eventually, by 12 meters, the main lobe has split into two forward lobes. Second, as we increase frequency, the array becomes more directional, with a growing differential between the forward and the rearward gain.

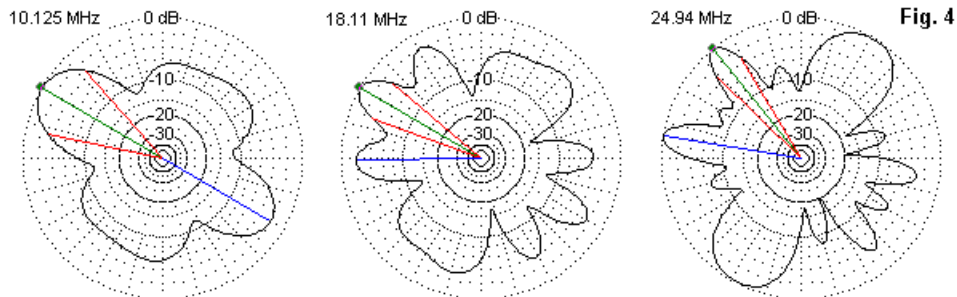

**Y-Doublet Azimuth Patterns: Potentially Usable Upper Bands**

Still, the patterns may be usable for general amateur operations. The question left is why we get reasonably low impedances at 30, 17, and 12 meters. **Fig. 5** shows part of the reason.

Fig. 5

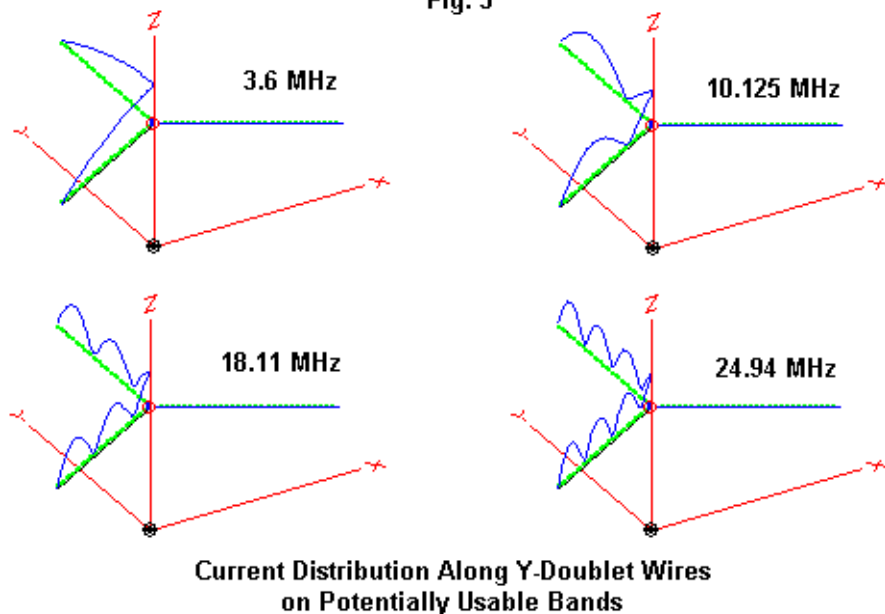

The graphics display the relative current magnitude distribution along the doublet for each of the 4 bands. On 80 meters, we have a somewhat typical dipole current distribution, with the current peak at the feedpoint. On the other bands, we approximate a  $3/2$ -,  $5/2$ -, and  $7/2$ -wavelength doublet current distribution. Each of these configurations places a current peak at the doublet center, resulting in a relatively low feedpoint impedance.

We should also note that the unused wire shows a flat current line. The current on it models out (in its perfectly spaced geometry) at

about 4 orders of magnitude less current than on the active wires. That is, if the current at the source is 1.0, then the current on the inert wire shows a value of 0.0001 or 1E-4 or less.

## The Feeder Question

The original system was designed for use with a twisted trio of feedline wires, in other words, a twisted pair plus one. **Fig. 6** shows the general hook-up, but without any poor attempt on my part to sketch a braid of 3 wires.

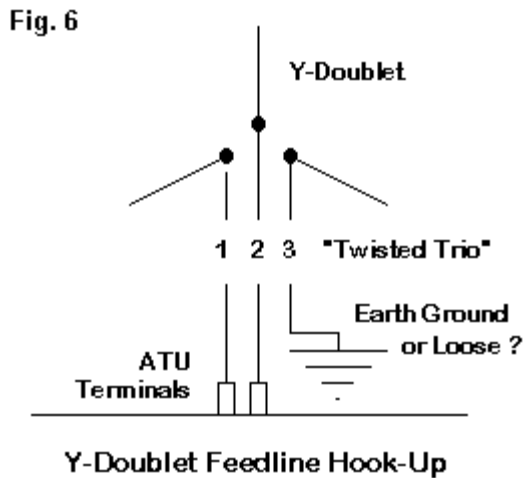

There are several questions about the feasibility of using such a system in modern times. The first quandary is whether we can build such a feeder system.

Modern insulated wire tends to use higher quality (lower loss) insulation than did the wire of yore. I would steer away from line cord, but modern wires use plastics with better RF characteristics, even if the only intend use is carrying DC. Since the system is designed for a low characteristic impedance, but with considerable SWR on the higher bands, I would recommend a heavy gauge wire, perhaps #12 or so. The actual characteristic impedance will depend on the thickness of the wire, the dielectric constant of the insulation material, and how tightly we hold the wires together. Consequently, I can give no exact figures.

However, you can make up lengths of a proposed feedline and check the impedance in a number of ways with a variety of dummy loads and a low-level signal source. Any one of the current crop of antenna analyzers will give you a fairly accurate reading. Given the relatively high dielectric constant of the insulating material, expect to find a significant velocity factor, something in the 0.6 to 0.7 region.

The next inquiry has to do with the effective inertness of the unused 3rd feeder wire. I re-created the model of the Y-doublet using parallel feedlines. Since twining the leads is not feasible in a physical model, I simply dropped the three leads straight down from the 50' level to 1' above ground. At that point, I connected two of the feeder ends with a 3-segment source wire. Again, all wires used a 1' segment length.

The resulting feedpoint impedances are not accurate to the low-Z feeder system. However, that was not the point of the tests using

the feeders with something over 800 Ohms as the characteristic impedance. The question was whether the unused antenna and feeder wires would remain inert relative to the active wires.

As one measure, the following performance table shows the effects of the added copper losses of the physically modeled feedlines.

.....  
 Y-Doublet Modeled Performance: 50' With Feeders  
 .....

Freq. MHz	Gain dBi	TO Angle degrees
3.6	3.35	34
10.125	9.74	26
18.118	9.60	14
24.94	9.85	11

.....

Gain remains virtually unchanged. So, too, do the patterns, and the outlines shown in **Fig. 3** and **Fig. 4** remain valid for the reconfigured model.

A second test is to check the current distribution along both the unused antenna wire and the ostensibly inert feeder. I actually performed two tests, one with the unused feeder simply left open and another with the feeder extended 1 foot to touch the ground. The 12-meter current distribution graphic in **Fig. 7** remains valid for both.

**Y-Doublet With 3 Feed Wires at 24.94 MHz  
(2 Antenna and Feed Wires Active)**

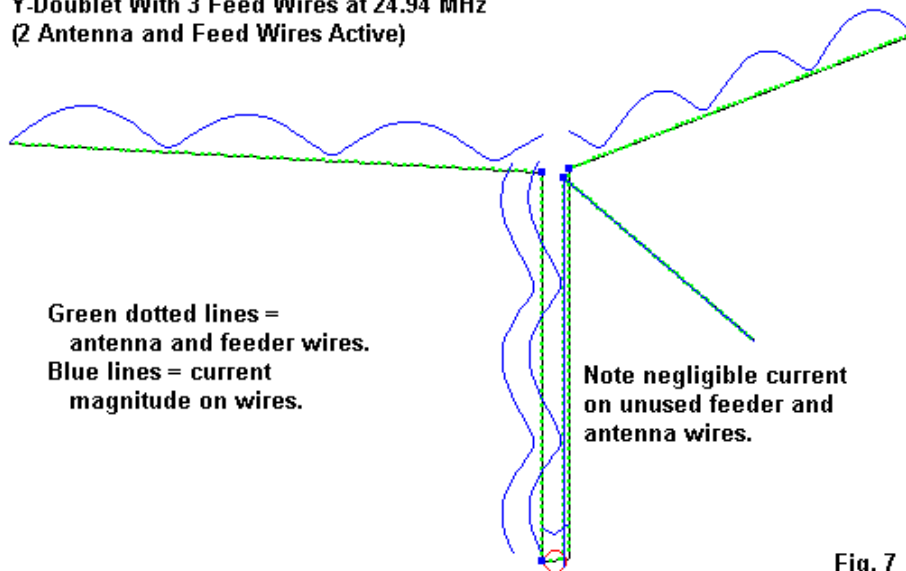
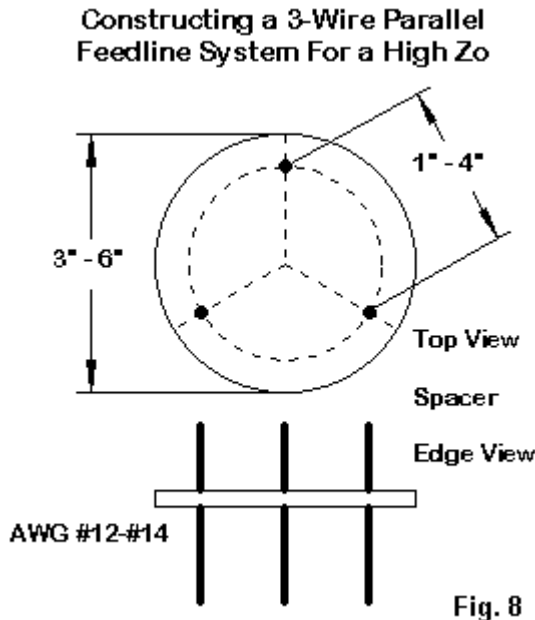

Fig. 7

Note that the current line on the unused feeder and antenna wires is flat. The relative current magnitude under either test condition on all of the bands remained less than  $1E-4$  relative to a source current of 1.0.

The modeling test, of course, has limitations relative to an actual twisted trio of wires. In the test, the modeled wires are widely separated and perfectly spaced along the entire 49' feeder run. How well the twisted trio performs may turn out to be as much a careful-construction issue as any other kind of issue.

However, the tests suggest an alternative feed system that just might open up the Y-doublet to use on all of the HF bands. **Fig. 8** tells the story.



The Y-doublet on the traditional upper ham bands, 40 through 10 meters, can show feedpoint impedances in the thousands of Ohms, with considerable reactance. Indeed, shrinking or expanding the basic 80-meter legs may prove useful in reducing the high reactance levels that accompany lengths that are close to even numbers of half-wavelengths. Commonly, we try to select for a



doublet a feedline characteristic impedance that is about the geometric mean between the feedpoint impedance extremes that we are likely to encounter. There is a practical limit to this effort, since lines above 600-800 Ohms are difficult to produce. Hence, 600-Ohm or so open wire becomes typical for such applications.

We can create a trio of pairs by using circular spacers of the type shown in the figure. For HF work, Plexiglas or polycarbonate spacers should be satisfactory. We can cut a hole in the center of each to reduce the weight. The holes can actually be slots if we add bridge wires to hold the spacers in place. In essence, we are adapting techniques normally used to create caged elements and applying them to the feedline. Such lines might permit the use of the antenna on all bands with a wide-range antenna tuner and will go a long distance in maintaining something close to the modeled ideal geometry we used in the test cases.

Of course, should you choose to work with a system of this order, you can replace the alligator and crocodile clips of yore with an in-shack switching system to change the orientation of the pattern on all bands.

The resurrected Y-doublet as some potential of still being serviceable today. There are many variables beyond the limits of this initial feasibility check, so success is not assured. However, for some hams who are restricted to backyard wire systems but who wish some directional flexibility, the system may be worth a try.

With the wide spaced feeder system, the system may also be adaptable to 102', 88', 67', and 44' doublet lengths discussed in other notes at this site and in mountains of other literature. However, as with all horizontal doublets, the rule of thumb that calls for the maximum feasible height remains in play for effective operation.

## Chapter 39: The Doublet - Trap or Not?

**T**he trap antenna, whether a doublet or a one-sided vertical, was invented mostly to permit the operator to use coaxial cable as a feedline. It was not invented for maximum efficiency. As with all antennas, trap antenna adherents claim they get good results--and indeed they do. Whether they get better results than they would with other types of antennas of comparable size is a question few are positioned to answer. The answer would require that the trap antenna and the alternative be placed in nearly the same position at the same height, and few of us can afford the space, time, or money for such side-by-side comparisons.

There are two types of trap antennas, with examples illustrated in **Figure 1**. The most common are those with traps, or parallel tuned circuits, that are resonant at or just below the edge of the higher frequency band to be covered, with extensions to make up the length of the lower band. These antennas will be shorter than a full-size dipole at the lower frequency, since the trap acts like an inductor at the lower frequency, much like a mid-element loading coil. However, the inductive reactance is not a product of the coil alone, but of the tuned circuit making up the trap.

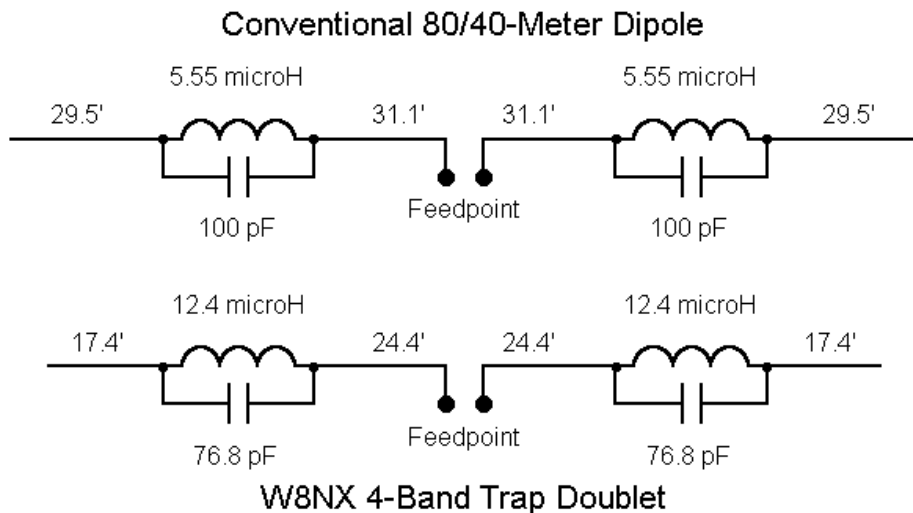

Figure 1

The second type of trap antenna is one with a parallel tuned circuit with the components and position selected to permit the antenna to show a low SWR one several of the ham bands. W8NX, who has done a great deal of work on these types of antennas, published an 80/40/17/10 meter antenna with only one trap each side of center, and it was tuned to 5.16 MHz (*QST*, July, 1996).

Let's look at the more conventional trap antenna first and simplify it to just 2 bands, like 80/40 or 20/10. A full size #14 copper wire resonant dipole will have a gain of about 2.1 dBi in free space, but it has this gain only in one ham band. We may use the gain figure as

a standard against which to measure trap antennas for two bands. The first thing we note is that performance of a two band trap antenna of conventional design is dependent very heavily on the Q of the trap. There are many trap designs, but here is a table of one pretty good design with coils of various Qs. The gain is for free space. Comparisons between dipoles and doublets at the same height above real ground will show the same differentials.

Q	High-Band Gain (dBi)	Low-Band Gain (dBi)
50	0.7	1.7
100	1.4	1.8
200	1.8	1.9
400	2.1	2.0
800	2.2	2.0

Avoid low-Q trap coil designs. It is fairly easy to homebrew air-wound coils with a Q of 200, and common coil stock usually meets this figure. Even the best series-wound coaxial trap coils will not have Qs higher than about 400, and most coils with Qs claimed to be higher than 400 will not retain that Q under the influence of the our chemistry-lab atmosphere. Nonetheless, a dipole with a gain of 1.8 or so will not yield results noticeably worse than a full size dipole, since a half dB of lost gain translates into less than a tenth of an S-unit. (Where these small losses mount up is in multiband beams with traps in every element, since the losses of each trap tend to be cumulative. They also add up in antennas with many traps for many bands.)

The sample conventional 80/40-meter trap dipole in Figure 1 uses traps tuned to 6.75 MHz. With a Q of 200, the traps equalize performance on the two bands at just above 1.85 dBi in free space.

This is only about 0.35 dB down from a full size dipole for each band.

Well, that's not too bad. What about the other type of antenna, like the W8NX improved trap antenna? Since the trap is not resonant at any ham band, the antenna is functional over its entire length at all advertised frequencies. On the three upper bands, the trap mostly adjusts the reactance that appears at the feedpoint so that coax can handle the feed task. On 80 meters, as Al Buxton notes, the trap does exhibit significant losses--about 0.6 dB relative to the gain of the wire of the same length (83.6') without the trap. (The 80 meter performance is down by a bit over 1 dB from a full-size dipole for 80 meters.) Since most of the impedances are close to 100 ohms, replacing the recommended 1:1 balun with a 4:1 balun will likely create no problems.

Since the W8NX antenna is operative along its entire length, its patterns are not true dipole patterns on all but 80 and 40. On the upper bands, they are multi-lobe patterns typical of a wire of the same length fed with a parallel transmission line and an antenna tuner--and at the same lobe strengths. So unlike the conventional trap antenna, the special trap design acts like a simple doublet.

Now we have an additional selection criterion for our decision-making machine. If we just have to have coax, then a trap design is desirable, especially if we do not have space for a yard full of standard dipoles. If we have to have standard dipole figure-8 or (at low heights) oval patterns, then the conventional trap design is indicated. If we have to have the coax, but are willing to accept

patterns that are a function of the antenna length, then the special trap design may be useful.

But--what if we do not really have to have coax? What if we could use parallel feedline and an antenna tuner. And--what if the dipole pattern were not too important to us? Should we still opt for a trap antenna? Probably not.

First, traps are always a maintenance problem. More than their losses, their inability to withstand weather without periodical disassembly and cleaning is a disadvantage to most users. Open traps are an invitation to big bug nests and closed traps invite little insects that get into weep holes and eventually clog them.

Second, a doublet with an ATU allows one to put a signal on all the ham bands. The W8NX antenna, without the traps, is about the right length for an EDZ on 20 meters, but the high reactance requires parallel feedline to avoid losses. With the traps and a coaxial feedline, the band is not accessible without significant power losses in the line.

Third, in the short run, a trap antenna may be cheaper than an ATU, but since ATUs are not out in the weather, they tend to last a lifetime. Hence, you can prorate their costs over many years more than a trap antenna.

So if you need the exact things a trap antenna offers, then opt for either the conventional or the special design types. On the other hand, if you prefer general operating on all bands, then simply put

up a doublet and feed it with parallel feedline and an ATU. The 121' of the conventional trap antenna would translate into a good doublet at 80 meters and up. Even the 83' length of the W8NX antenna--which is short by G5RV standards--when used as a doublet without traps, will still give performance every bit as good as any trap antenna and on more bands. The length of a doublet is not critical, but a. try to make it at least close to  $3/8$  wavelengths long on the lowest frequency needed and b. be ready to change parallel feedline lengths in case you run into the occasional impedance condition your tuner cannot handle well.

Remember that there is no magic to any kind of trap or doublet antenna. For the band in use, the elevation angle of maximum radiation will be the same as a dipole at the same height above ground. Therefore, more height is always a key to improved performance of any trap or doublet antenna.

My object is not to downgrade traps: use them where your system's specifications demand them. But do not neglect the multiband doublet, which can be just as good and occasionally better for many installations. Hopefully, setting the two side-by-side here will let you make a more reasoned decision for your installation.



## Chapter 40: Some Notes on Triangles of Doublets

**O**n occasion, folks have asked me questions of this sort: My all-band doublet doesn't seem to be doing the job. So what if I replace it with a longer one, a loop, or whatever? Or suppose that I add an antenna of a different kind to the existing doublet? What should I do?

In many cases, I recommend a second or third antenna of the same type. It struck me that perhaps some short background on why I make that recommendation on some occasions--but not all--might be useful to those who do not have much experience with all-band wire doublets.

### The Single Doublet

Every wire antenna has a length (in feet, meters, etc.) and a height. We shall use a center-fed doublet throughout these notes. Since our question does not directly involve elevation angles of radiation for the best DX, etc., I shall use a constant height of 50' above average ground for this discussion. Those constants will allow us to make direct comparisons. Anyone with lower or higher wires can read other notes at this site to make any adjustments in the comparisons.

A difference of height will make little or no difference in the azimuth patterns of a doublet as we move from band-to-band (as long as the antenna is not too close to the ground). The pattern is mostly a function of the antenna length in terms of wavelength at each

operating frequency. Small changes of frequency do not materially affect the pattern, so we can use a single frequency on each band as a sample that holds true for the whole band.

Let's start with a 135' center-fed doublet. 135' is about (and "about" is plenty good enough here) 1/2 wavelength long on the 80-75-meter band. At 40 meters it is 1 wavelength. On 20, it is 2 wavelengths, and on 10 it is 4 wavelengths.

Any center-fed doublet will have only 2 lobes for any length in wavelengths up to and just beyond 1 wavelength--1 lobe on each side of the wire, broadside to the wire. When the antenna is 2 wavelengths long, there will be 4 lobes--2 on each side of the wires--and they will angle away from the wire leaving a null directly broadside to the wire. A 4-wavelength antenna will have 8 lobes--4 on each side--and the strongest ones will be angled further away from the broadside directions.

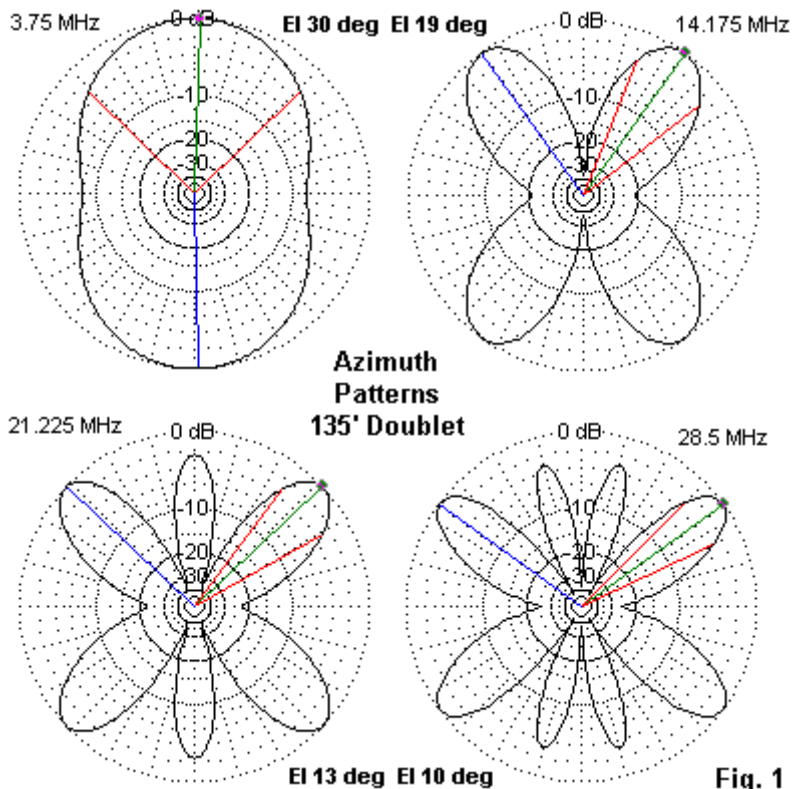

**Fig. 1** provides snapshots of the azimuth patterns that reflect the notes I just gave. In addition, it shows the 15-meter situation. The antenna is 3 wavelengths long, so we get 6 lobes. For all of the patterns, the antenna runs from left to right (or right to left) across the center line of the plots. So broadside is up and down on the patterns.

The first thing we can do with these patterns is explain why a given doublet gives good results in certain directions on some bands but not on others. Assume that we set the wire in the U.S. so that broadside goes to Europe and to Australia. By the time we operate on 15 to 10 meters, our strongest lobes are no where near the headings for those two major target areas.

So our first lesson is in wire antenna orientation. By knowing the antenna length, we can roughly determine the directions of lobes on our favorite bands and set up the wire to give the strongest performance in those directions by how we orient the wire. We cannot obtain a perfect setting on all bands, but we can (assuming that we do not need to move any supporting trees) obtain good settings on our favorite bands.

Before we look further at the matter of direction, we have a few more preliminaries to note. For example, what band should I choose as the basic one for DX in my favorite directions? Here is where a small performance table may help for the bands illustrated in **Fig. 1**.

.....  
 135' Doublet Performance at 50' Up

Freq. MHz	Max Gain dBi	TO Angle deg
3.75	3.2	30 (arbitrary)
14.175	9.4	19
21.225	9.8	13
28.5	10.6	9

.....

The TO or take-off angle is the elevation angle of maximum radiation. It is correct for 20-10 meters, but is not for 80 meters, where the height of the antenna is low enough to direct most radiation at very high angles. So I chose a reasonable short-skip angle to take the gain reading.

Since the gain on 80 is so low and the radiation angle so high, 80 is not a good candidate for use in orienting the antenna for DX directions. The gain on 20, 15, and 10 are similar, so one of those bands is a better candidate. However, if we prefer local rag chewing, then the 80-meter broadside should aim at our target areas. Remember that the 40-meter pattern will also be a 2-lobe broadside affair, but the strength will be higher and the beamwidth narrower (since the added gain has to come from somewhere).

There are, of course, a number of other amateur bands on which the antenna is not close to an integral number of wavelengths long. What happens when the antenna is  $X.5$  wavelengths long, where  $X$  is any integer? The answer is a function of how lobes appear. They do not pop into existence, but grow and shrink as we change the length of the antenna (or as we raise and lower the operating frequency, which achieves the same change in antenna length when measured in terms of wavelengths). At  $X.5$ -wavelengths, the azimuth pattern will show two sets of lobes in approximately equal strength: the set for wavelength  $X$ , longer than which we now are, and the set for wavelength  $X+1$ , which we are approaching.

On 17 meters, a wavelength is about 54' long and our 135' doublet is about 2.5 wavelengths long (give or take a little). (A wavelength

is about  $984/f$  feet long, where  $f$  is the frequency in MHz.) We shall have 4 lobes for the 2-wavelengths that we passed in length. We shall have 6 lobes for the 3-wavelengths that we are approaching. So the pattern will be composed of 10 lobes total. That sounds good, since we get lobes in so many different directions. However, for every lobe, there is also a null. So we have 10 blank directions and each lobe is narrower than its counterpart in a 2-wavelength or a 3-wavelength wire.

This note on nulls gives us the second lesson concerning wire doublets and their azimuth patterns. Study the azimuth patterns twice. First, look at the lobes that tell you where the radiation is going. Second study the nulls that tell you where performance will be very weak. Only then should you make decisions about how to orient the antenna.

What happens when a wire is  $X.25$  or  $X.75$  wavelengths long. Since lobes grow and shrink, the answer is almost obvious. At  $X.25$  wavelengths, the wire is not long enough for strong lobes from the  $X+1$  length, but will show some smaller lobes derived from that length. At  $X.75$  wavelengths, the wire is too long to support full scale lobes from the  $X$  length, but will have smaller lobes (meaning lower gain) still present. In either case, as some lobes show low development, the larger ones are that much larger, since the radiated power is relatively constant (ignoring external variables) across all frequencies.

Now suppose that you have studied the azimuth patterns and decide that you cannot place a strong lobe every where that you

want to communicate. It is precisely here that folks immediately jump to thoughts of other antennas. But virtually every other horizontal wire antenna, whether straight or looped, has a pattern of lobes and nulls. Most of them are more complex to install. So what is a solution to our quandary?

Now wire is relatively cheap. Antenna supports are not. So any solution that we come up with should have the desirable property of involving a minimum of new supports.

### **The 135' Doublet Triangle**

There is no perfect solution to the problem of working everywhere we want to work with an array of horizontal wire doublets. However, we can go a good distance toward that solution by adding only one more antenna support. We shall create a triangle of wire doublets, something like the idealized sketch in **Fig. 2**.

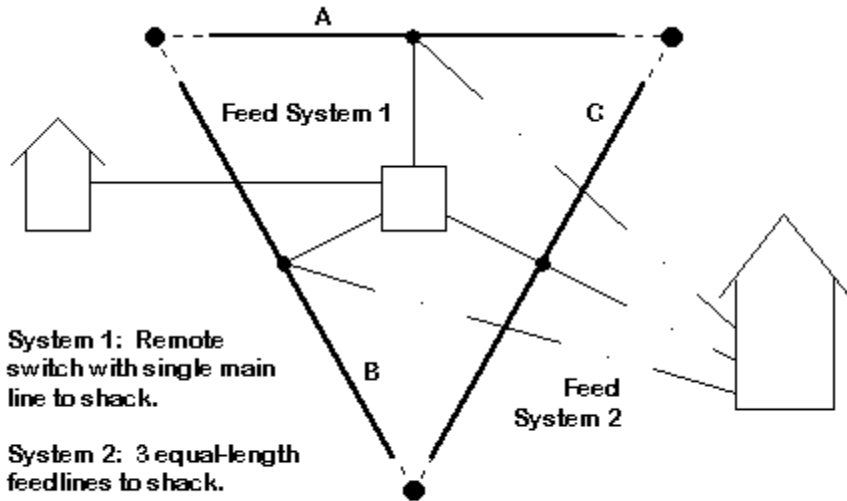

Wire Triangle Basics

Fig. 2

The drawing shows an equilateral triangle, but almost any shape will do. In fact, a better idea is to angle each antenna so that its lobes--on your favorite bands--hit your favorite targets. Just give yourself a little separation at the wire ends--perhaps 10' on the end of a 135' doublet--to minimize interactions among the wires.

The sketch also shows two different means of feeding the antenna. You can run 3 feedlines, each the same length as the others, to a central point where you install a weather-proof relay box to switch among the wires. A single feedline runs to the shack, along with a



relay power line and switching lines via an A-B-C switch to activate one of the 3 antennas at a time.

The alternative is to run three lines, again, all the same length, to the shack for use with a manual A-B-C switch at that location. Since the lines will be parallel transmission lines, follow the usual precautions about keeping them free and clear of anything that might disrupt their balance.

The point of using equal-length lines in each case is so that you can switch between antennas and determine by ear the strongest signal. If they are not the same length, you will have to do some rapid re-adjustment of the tuner settings for each switch position. With identical antennas and feedlines, you should be able to pick out the strongest one and then only do a final tweaking of the settings on the tuner.

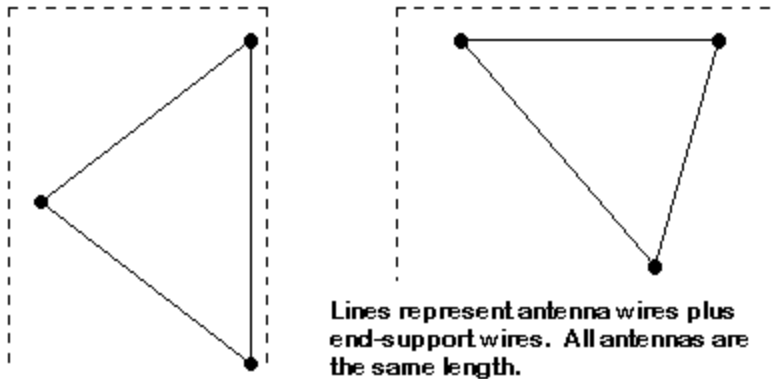

Samples of Fitting a Triangle to a Yard

Fig. 3

As **Fig. 3** shows, you may not always have a good choice as to exactly where you position the supports for the antenna. Fitting the triangle to available yard space is an eternal amateur antenna problem. However, as we shall see, we can effect some improvement on our operation, even if we cannot perfect it.

Notice that we were able to add two antennas for the cost of wire and with only one extra support. We may well trade any remaining imperfections in the system for that major simplification of structure.

Now the question is simply this: what do we get for our pains? The easiest way to show what we get is by overlaying azimuth patterns for each antenna in one massive plot for each band covered in **Fig. 1**. We shall note both the advantages that we accrue from the new arrangement and the remaining problems that we could not solve.

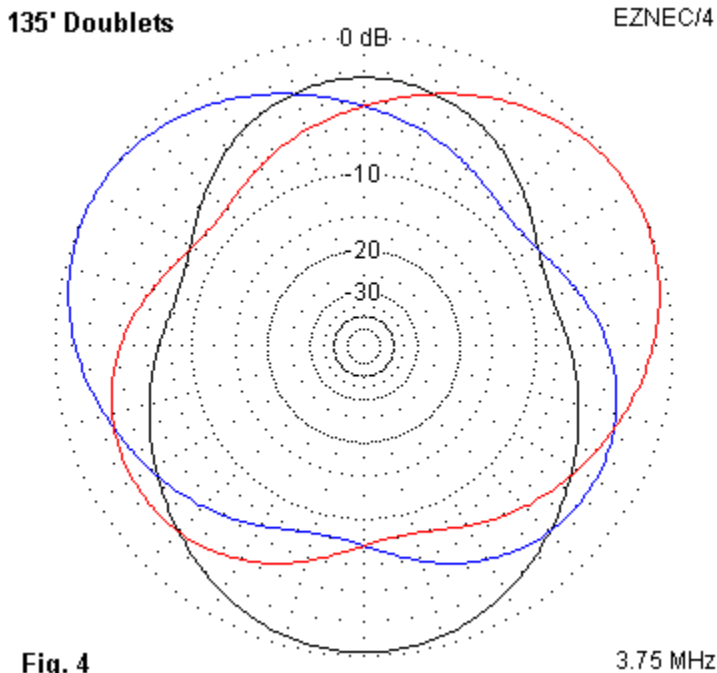

**Fig. 4** shows the three antenna patterns at the same 30-degree angle that we used in **Fig. 1**. It is immediately apparent that we can cover more of the horizon with our signal (and reception) than with a single antenna. However, since the antenna is close to  $1/2$  wavelength, there is some interaction between the antennas so that the inactive ones act as reflectors. The 2-dB difference should not affect performance too much. You will find the same phenomenon on 40-meters, where the wires are all nearly 1 wavelength.

135' Doublets

EZNEC/4

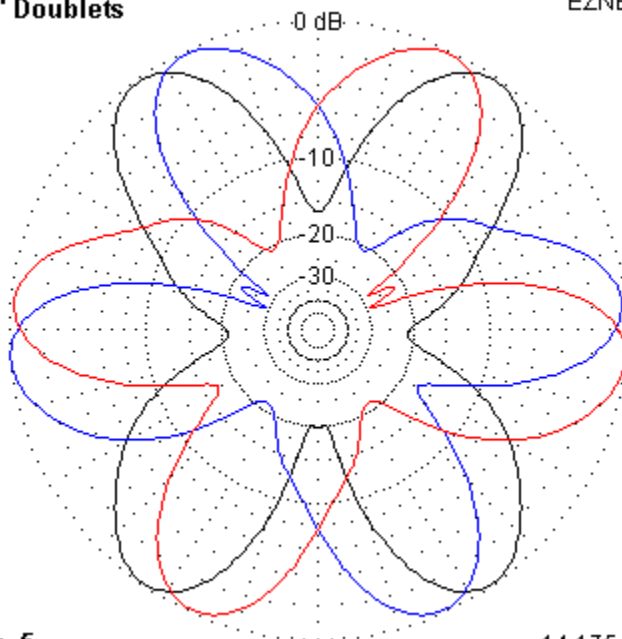

Fig. 5

14.175 MHz

The 20-meter situation appears in **Fig. 5**. We still have some nulls, but count the major directions that we can cover, letting overlapping lobes count as 1. We have 6 directions, not just the 4 that a single wire would give us. As well, the overlaps are not perfect, so that a signal that is on the fringe of one lobe may be centered in overlapping one. Of course, by carefully planning of your triangle, you can minimize the overlap and spread the area of coverage. The patterns shown simply use our equilateral triangle as their basis.

135' Doublets

EZNEC/4

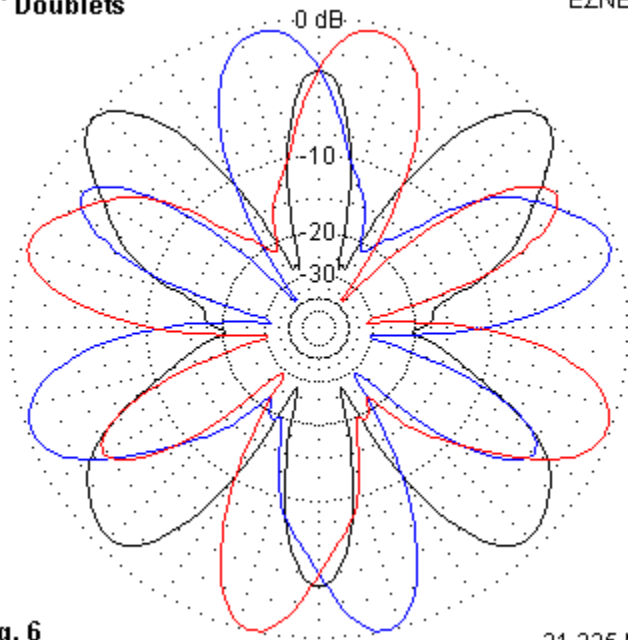

Fig. 6

21.225 MHz

In **Fig. 6**, we find 15-meter quite well covered by the 3 antennas and their strongest lobes. Indeed, 15 meters is a band that really benefits from a triangle of 135' doublets.

135' Doublets

EZNEC/4

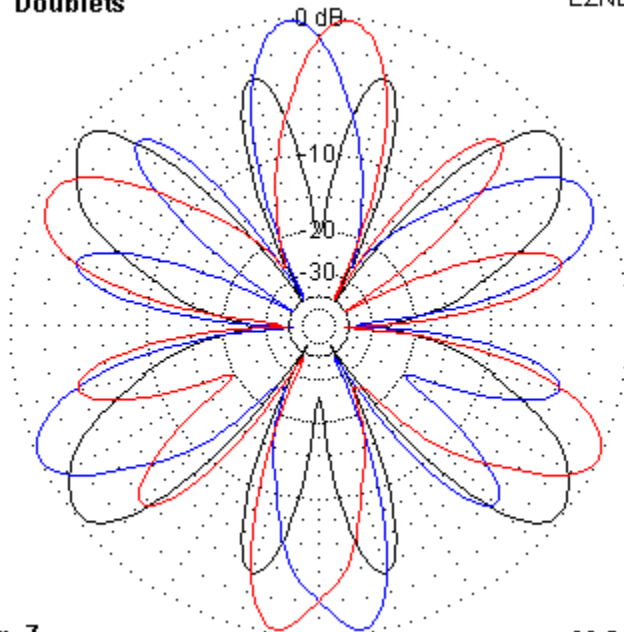

Fig. 7

28.5 MHz

If you look at **Fig. 5** and **Fig. 7**, you may get the impression that when an antenna is an even number of wavelengths, it leaves more nulls than when it is an odd number of wavelengths, as in the 15-meter case. In general, this is a correct conclusion, although as we further increase the antenna length, the number of lobes becomes high enough to make it difficult to tell the difference. 10-meters is a good band for which to redesign the triangle to place a lobe in the direction that you want it.

## The 88' Doublet Triangle

If you lack yard space for 135' doublets in a triangle, you might try 88' doublets. Here is a performance table for a single doublet on the same bands that we surveyed for the longer doublet.

.....  
 88' Doublet Performance at 50' Up

Freq. MHz	Max Gain dBi	TO Angle deg
3.75	2.8	30 (arbitrary)
14.175	10.1	19
21.225	9.1	13
28.5	10.3	9

.....

The performance figures for each band are not very much different than for the 135' doublet, but the patterns are considerably different. Remember that the 88' doublet is only about 1/3 wavelength at 3.75 MHz. **Fig. 8** shows the 88' doublet azimuth patterns when we place the antenna 50' above ground.

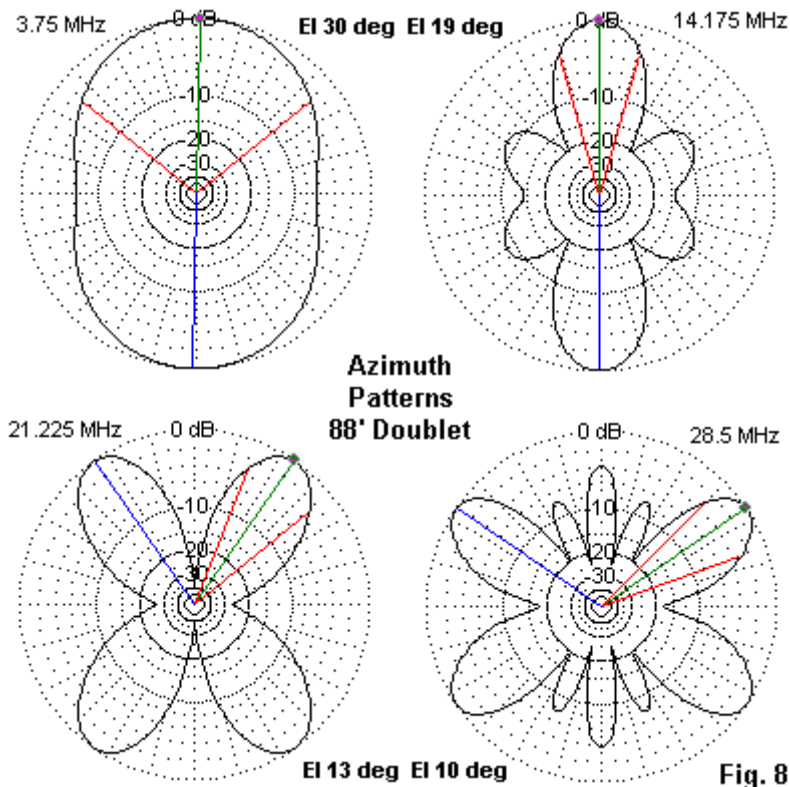

The 80-meter pattern is similar to the one for the longer wire. However, the 20-meter pattern shows the typical "ears" of an extended double Zepp, since that is exactly what the antenna is at 14 MHz. It is 1.25 wavelengths, which means that the 2-wavelength lobes are just beginning to emerge. On 15 meters, the wire is 2 wavelengths long and shows the same sort of pattern that the 135'



doublet showed on 20 meters. The 10-meter 88' doublet pattern is an example of a 10-lobe pattern for a 2.5-wavelength antenna.

Besides taking less space, the triangle of 88' doublets also shows less interaction among the wires. Hence, we can use somewhat smaller separations of the wire ends in making the triangle. However, in exchange for spatial economy, we shall encounter differences in the ability of the triangle to fill in the nulls on the single-wire patterns.

**88' Doublets**

EZNEC/4

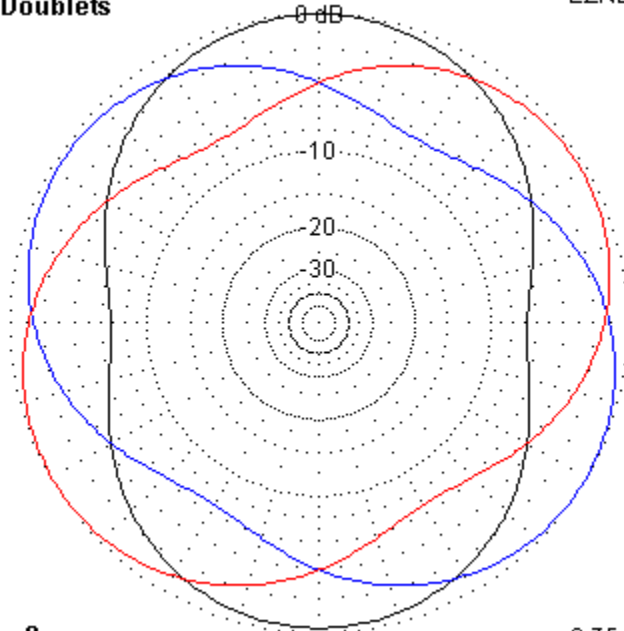
**Fig. 9**

3.75 MHz

On 80 meters, as shown in **Fig. 9**, the absence of pattern distortions created by interactions among the wires yields almost complete horizon coverage. However, remember that this pattern is at an elevation angle of 30 degrees, and most radiation is upward. We can improve long-haul performance of the triangle by "merely" raising the supports to the 90-100 foot level.

88' Doublets

EZNEC/4

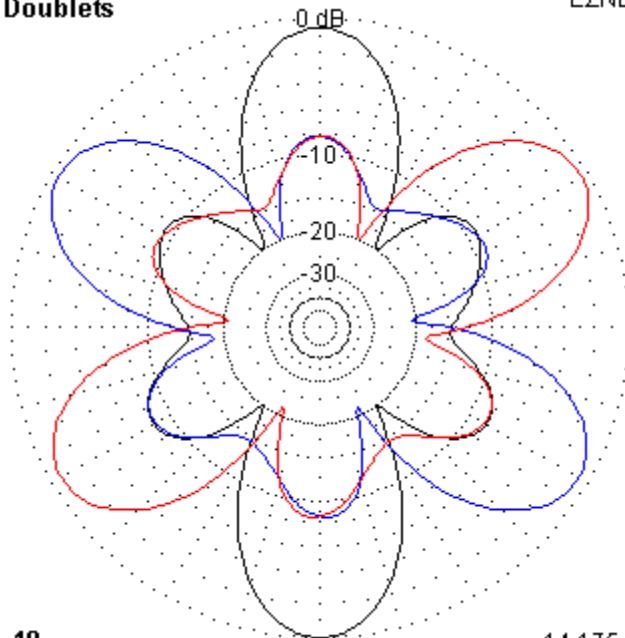
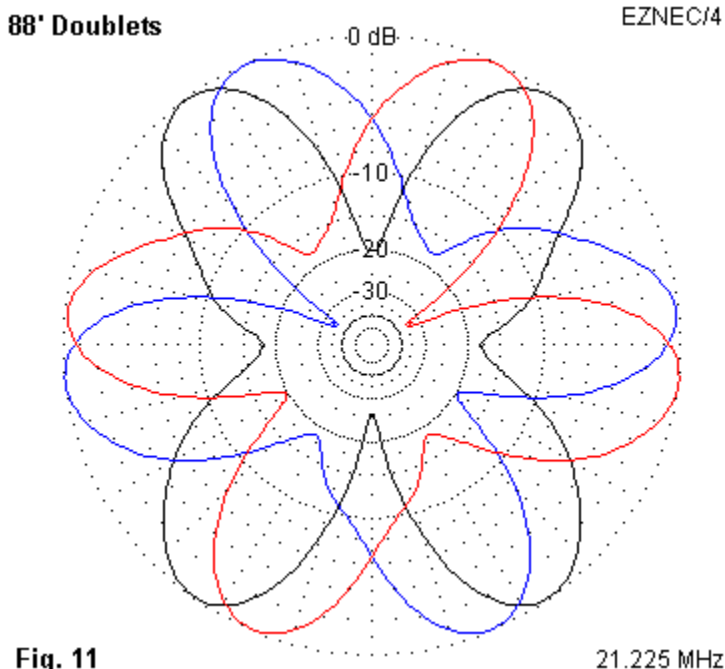

Fig. 10

14.175 MHz

**Fig. 10** shows us the 20-meter combined patterns. The azimuth plot provides a good model for a hex symbol to embroider for good

luck. More importantly, it shows some nulls that may call for careful design of the triangle to ensure the desired target-area coverage.



Like its counterpart 20-meter pattern, the 15-meter patterns in **Fig. 11** add up to fairly complete coverage, but with nulls and overlapping lobes. Hence, one might wish to design the triangle to spread the lobes a bit. However, you will discover that with 4 lobes per wire, every spread in one direction increases an overlap somewhere else.

88' Doublets

EZNEC/4

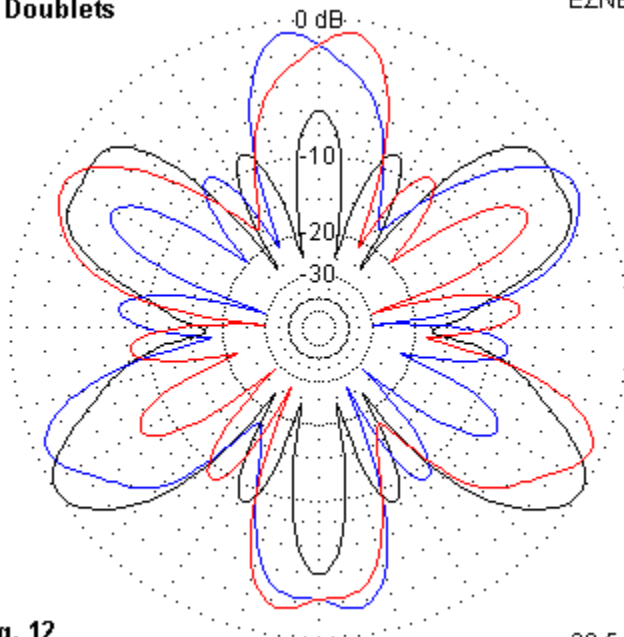

Fig. 12

28.5 MHz

The situation grows both better and worse on 10 meters, as shown in **Fig. 12**. The null areas are wider, but often not as deep, since minor 10-meter lobes fill the null at about 1.5 S-units lower strength. Once more, designer triangle formation seems the order of the day.

It would be difficult in a general discussion to provide samples of designer triangles, since each would prove useful for only one region of the U.S.--and likely be useless outside the U.S. However, one can experiment most easily with altering the triangle

orientations with modeling software. There are inexpensive packages, and even some free MININEC programs. It may pay to master them well enough to go with your self-study geography lessons in order to give yourself the best chance of placing doublet supports at the correct locations.

In the end, there are no perfect solutions. However, at a cost of one extra support and a bale of wire--plus feedlines and an A-B-C switch--you cannot get much better horizontal coverage much more cheaply than with a triangle of doublets.

An additional caution or two: The doublet lengths used here place the lowest band at 80 meters. You can use a 70' doublet if you wish to cover 40-10 meters. In that case, the 80-meter and the 20-meter patterns shown in **Fig. 1** become the patterns for 40 and 10 meters, respectively. As well, you can use a 44' doublet in place of the 88' version used in these notes. The same adjustments then apply to the patterns in **Fig. 8**. In both cases, the performance data in the tables would apply with band adjustments to an antenna at about 25' above ground.

## Xs and Ls

Some folks ask what happens when we have only two doublets. They envision crossing or end-to-end arrangements like those in **Fig. 13**. However, they often have in mind to use something other than a right angle.

Fig. 13

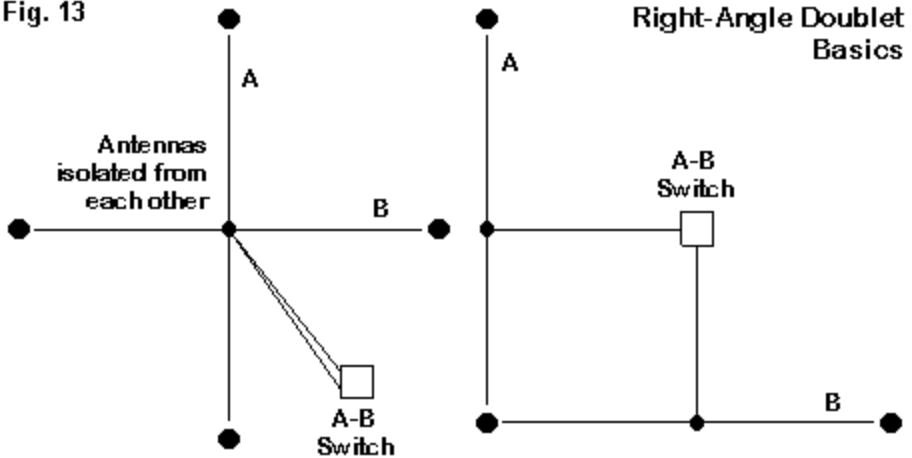

The first thing that happens is a requirement for either 1 or 2 more support posts. If you have plenty of Douglas Firs handy, a 4-post system is no problem. But if you have to construct or erect your own supports, then the support work either matches or exceeds the work required by a triangle. The L-configuration is like the triangle, but only lacks 1 wire and its associate feedline. Of course, you can now get away with an A-B switch, rather than having to figure out how to make an A-B-C switch.

Let's put up 2 135' doublets that cross at the center (with a separation to keep the wires apart) and see what we can achieve with only 2 antennas on each of our sampling bands.

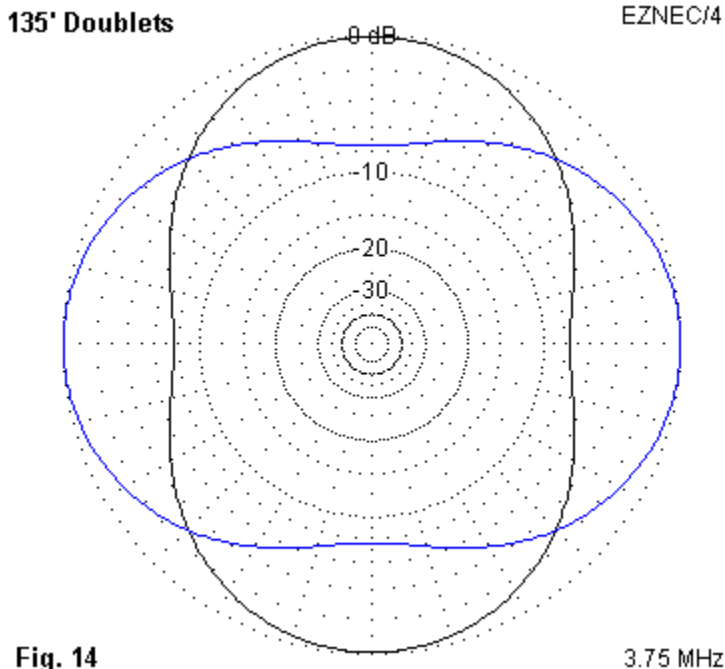

**Fig. 14** shows the 3.75-MHz results. Since the deepest null is now only about -3 dB or about 1/2 S-unit, it is likely that performance will be satisfactory within the height limitations that we discussed earlier.

135' Doublets

EZNEC/4

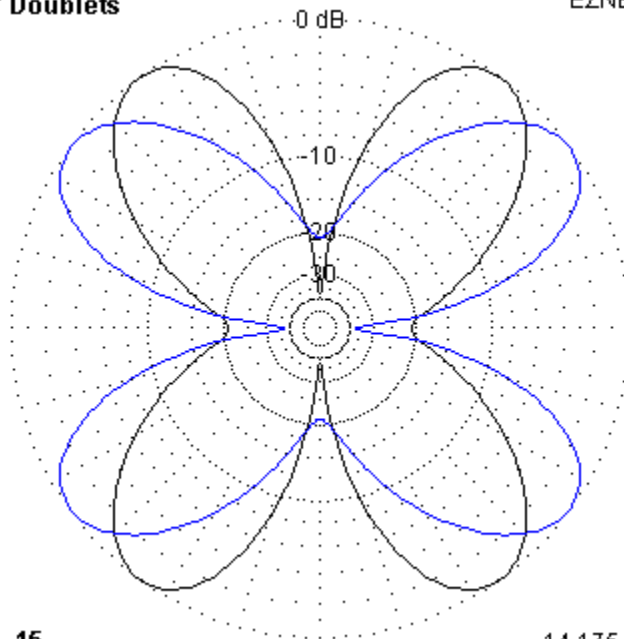

Fig. 15

14.175 MHz

On 20 meters, as shown in **Fig. 15**, we have deep nulls and considerable lobe overlapping. Hence, for this band, adjusting one antenna by at least 25-30 degrees off a right angle will likely produce better coverage. For an individual antenna, the lobes are only about 35 degrees each side of a broadside tangent line relative to the wire, so some angling to enhance coverage seems in order.



135' Doublets

EZNEC/4

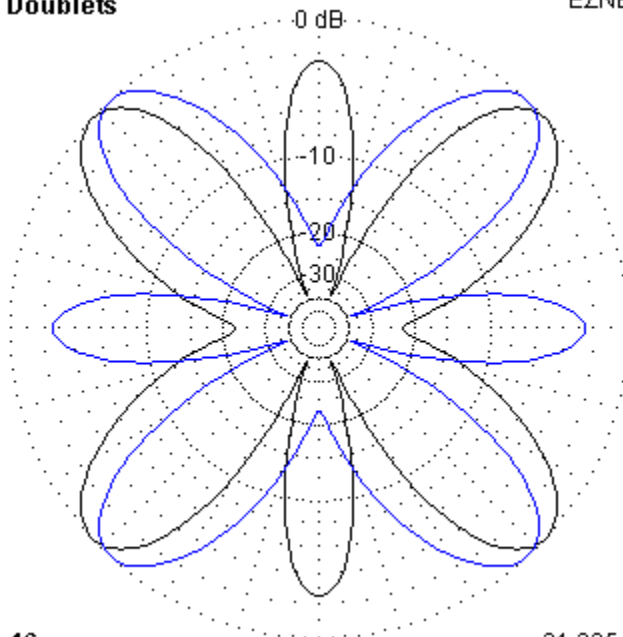

Fig. 16

21.225 MHz

**Fig. 16** gives us the 15-meter story. Once more, the main lobes heavily overlap, but each is about 40 degrees off the line tangential to the antenna wire. Finding a compromise angle for both 20 and 15 meters will require some thought, especially when we add in the need to be aiming at communications target areas.

## 135' Doublets

EZNEC/4

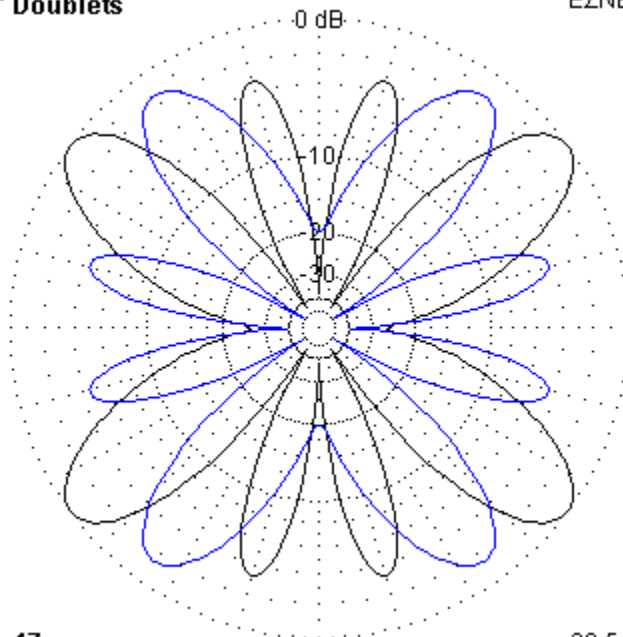

Fig. 17

28.5 MHz

The most thorough coverage occurs on 10 meters, due to the multiplicity of lobes. See **Fig. 17**. Despite the gaps or nulls that remain on each of the bands, the level of coverage with just two 135' doublets is significantly greater than with a single doublet. Conclusion: if you cannot swing 3 antennas, at least try for two.

The 88' doublet does not fare quite as well in a 2-wire system as the 135' doublet. Indeed, the 88' doublet seems best suited to a triangular environment.

88' Doublets

EZNEC/4

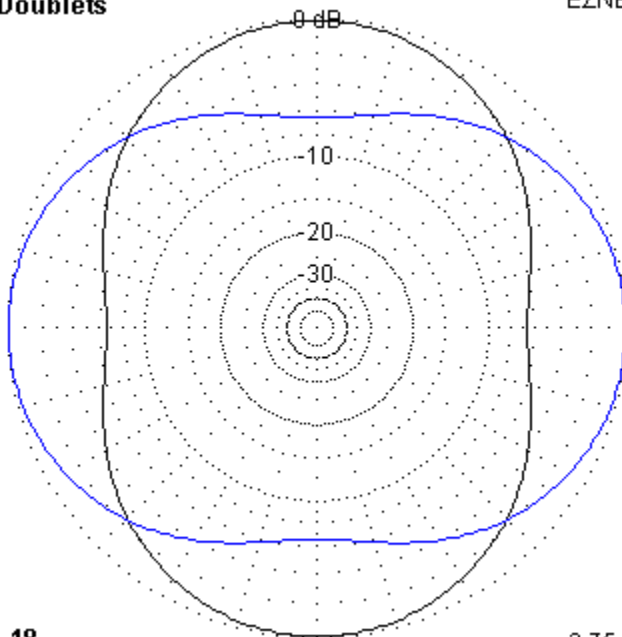

Fig. 18

3.75 MHz

80 meters appears in **Fig. 18**. As is evident, there is no significant difference between the 135' and 88' 80-meter situation with respect to coverage.

88' Doublets

EZNEC/4

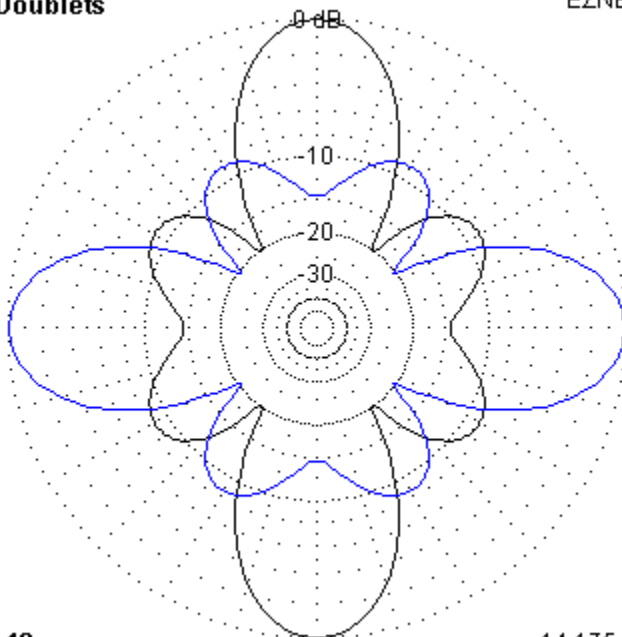

Fig. 19

14.175 MHz

The 20-meter patterns are in **Fig. 19**. The extended double Zepp patterns simply give us two different bi-directional options. Hence, careful broadside aiming of the wires seems the order of the day.

88' Doublets

EZNEC/4

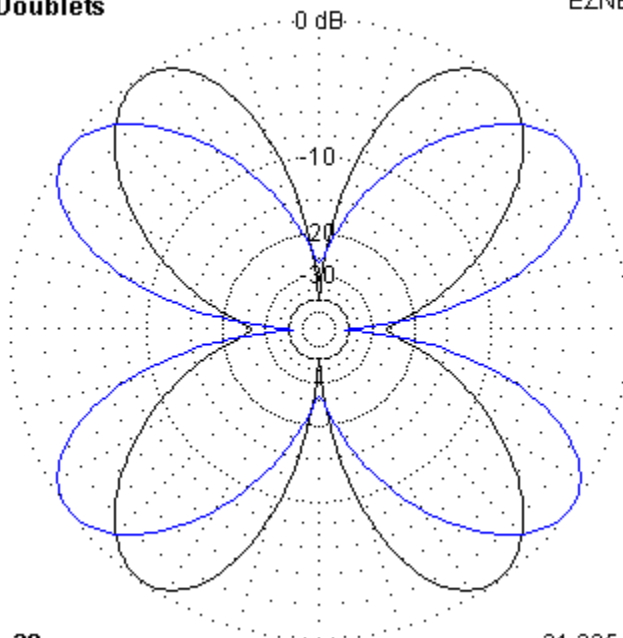

Fig. 20

21.225 MHz

If we wish to target areas on 20 meters, they will be broadside to the antenna. However, on 15 meters, as shown in **Fig. 20**, we cannot target the same areas, since the lobes on that band angle away from broadside by about 35 degrees. Unlike the situation with a triangle of doublets, the 2-wire system of 88' doublets appears to force us to declare that either 20 or 15 meters is our favorite band, but not both--at least not into the same parts of the world.

88' Doublets

EZNEC/4

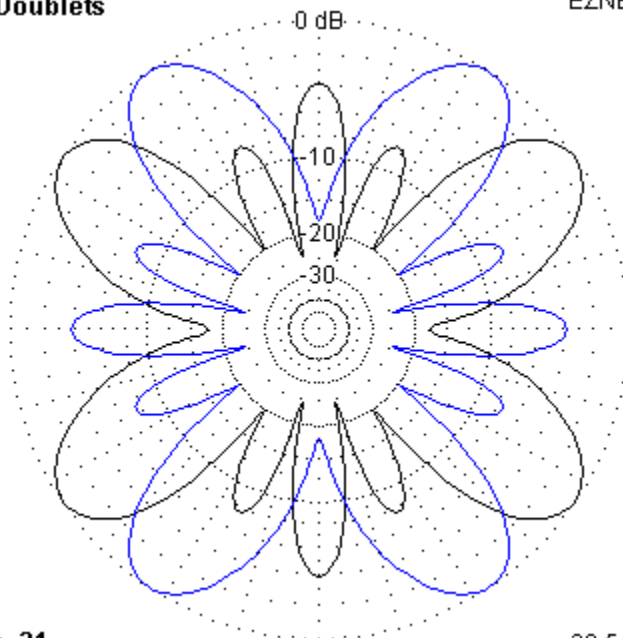

Fig. 21

28.5 MHz

**Fig. 21** gives us the 10-meter picture. At 2.5 wavelengths, the antenna yields fairly solid coverage, although there likely is room for wire aiming on this band.

However we construct the doublets, the triangle provides superior coverage and more versatility than a crossed or L-ed doublet system. Obviously, 2 wires are better than 1, but 3 is significantly better than 2 without requiring any further supports.

I have omitted construction details, since they are so variable with the circumstances of the individual builder. As well, I have omitted inverted Vees, which will tend to change the situation on the lower bands more than on the higher, since the patterns will be broader ovals.

Nevertheless, the switched doublet triangle offers flexibility that takes advantage of the strongest lobes--especially on the upper bands--in the antenna pattern. A switched-doublet system is cheaper than a rotator and tower system, and repair costs are reduced usually to the cost of antenna wire and possibly some parallel transmission line. However, the performance of a wire--when you can place one of its main lobes on the desired station--can be surprisingly good.

Nothing here is intended to compare the doublet with other wire antennas--or even non-wire antennas. These notes are intended only to show some possibilities that we often overlook when thinking about wire doublets.

A love triangle is usually a disaster. However, a triangle of doublets is often a happy marriage of economy and performance.

## Chapter 41: 40-Meter Vertical Arrays

**T**he lower HF amateur bands tend to feature vertical antennas. We find a few horizontal beams, especially on 40 and 30 meters, but they tend to be very large, heavy, and expensive. In contrast, vertical arrays make use of wire and usually use much simpler construction. Hence, their maintenance requirements are also simpler.

At 40 meters (and by extension and scaling 30 meters as well) the vertical dipole becomes feasible, especially if we find a way to shorten it somewhat without losing significant performance. From the vertical dipole, we may create a large number of array types. In these notes, I want to examine in order of increasing performance capabilities a collection of vertical dipole beams and arrays. So that all comparisons will be fair, every vertical array will use AWG #12 copper wire, perhaps the most common material for amateur wire antennas. As well, all antennas will be over average soil (conductivity 0.005 S/m, relative permittivity 13). The performance of vertical antennas will change with the quality of the soil beneath them and in the far-field reflection zone, but the changes will tend to be consistent within any given soil type. Therefore, if we know the performance of an array over average soil and the relative performance for a simple vertical dipole over both average soil and the specific soil type for a given installation, we may extrapolate the performance values for a more complex antenna system.



## Vertical Dipole Basics

The root antenna for what follows might seem to be a vertical dipole. **Table 1** and **Fig. 1** summarize the properties of a vertical dipole that extends from 1' above ground level to a top height of 67.6'. The total wire length is 66.6', but this exact value applies only to a resonant vertical dipole over average soil. Slight adjustments are likely for different soil types, especially since the lower end of the antenna is so close to the ground. As will be the case for all models used in these comparisons, the performance and dimension values do not account for the influence of objects in the immediate area of the antenna installation, that is, the so-called ground clutter. All vertical antennas require as much clearance from ground clutter as the installation site will permit.

### 1. Full Length Vertical Dipole

Bot Ht	Top Ht	Length
feet	feet	feet
1.0	67.6	66.6

Performance over average soil		
Gain	TO Angle	Feed Impedance
dBi	degrees	R +/- jX $\Omega$
-0.15	18	98.0 - j0.1

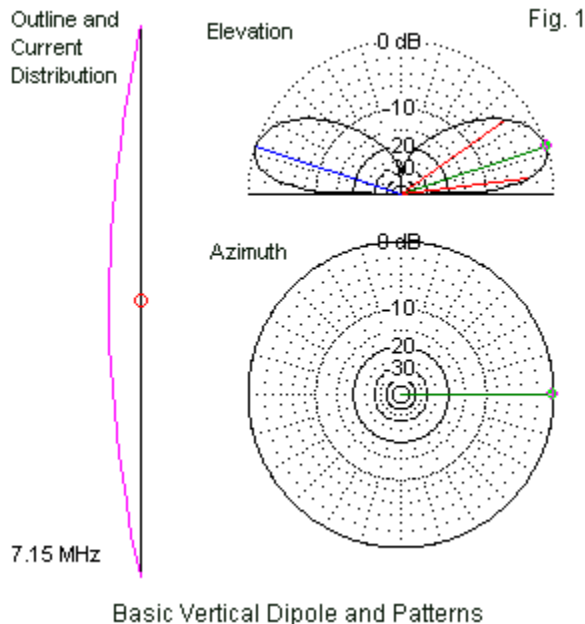

For this and all following antennas, the test frequency will be 7.15 MHz. The clutterless radiation patterns show very normal characteristics--a circular azimuth pattern and a single elevation lobe with a low take-off (TO) angle. Hence, despite the low gain of the antenna, it finds general favor for its coverage and for its insensitivity to high-angle noise and signals. The simple outline sketch shows the current magnitude distribution along the antenna wire. One reason why the antenna patterns show a low TO angle stems from the relatively high position of the feedpoint or the region of highest current magnitude, just about 1/4-wavelength above

ground. However, the close proximity to the ground at the lower end of the dipole does elevate its feedpoint impedance--from an expected 70-Ohm value up to the 98-Ohm value reported by NEC-4 for the sample antenna.

Many amateurs do not have 70' supports for a 40-meter vertical dipole in its simplest form. Individual circumstances vary, but let's suppose that the maximum support height is about 50'. Within this height restriction, we may still install a modified vertical dipole. Rather than accept the losses that center-loading or mid-element loading might create, we shall use end hats. An end hat or cap is a symmetrical structure at right angles to the main plane of the antenna. Radiation from the wires of the end cap largely self-cancels, leaving us with a vertical antenna in terms of the radiation patterns. Since the self-canceling portion of the radiation occurs in the low-current regions of the antenna, we preserve most of the performance that we might obtain from a full-length dipole. **Fig. 2** shows the outlines and current distribution on one version of such a T-capped dipole/

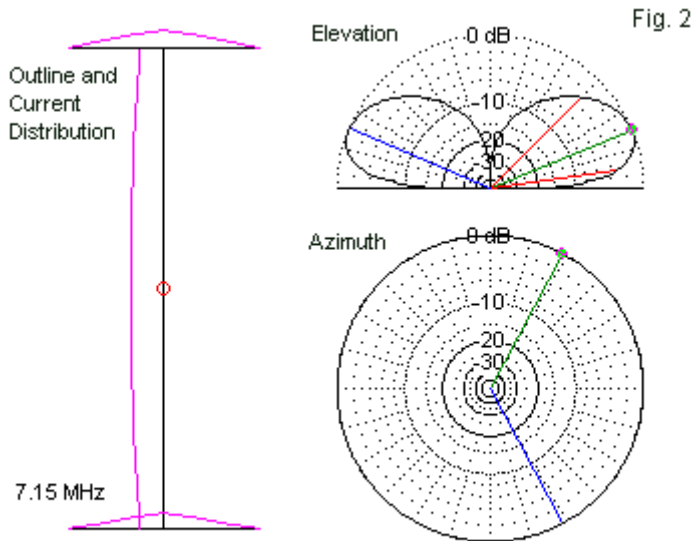

T-Cap Vertical Dipole and Patterns

The end hats on a vertical dipole can use any symmetrical arrangement. The more radial arms that we create, the shorter each one must be for a given length of vertical wire in the center. However, many-spoked hats set up very significant support requirements. The T-cap requires only two wires at each end of the dipole, and we may run these wires along the non-conductive ropes that we often use to support wire vertical dipoles between two posts or trees. Reducing the number of hat wires to only two per end does not affect the performance relative to using greater numbers of hat wires. For example, the azimuth pattern of the T-cap dipole in

the sketch shows only 0.03-dB of gain variation as we check all 360 degrees of the horizon.

The T-cap dipole that **Fig. 2** shows is only 35.5' long, stretched from 5' to 40.5' above ground. (One might easily raise the antenna by another 4 to 5 feet and still remain below the 50' ceiling that we set. The added height would also increase safety by raising the base wires with their high RF voltages above the level that family, friends, or even pets might touch.) The vertical section, then, is just over 1/4-wavelength. For all following 40-meter vertical antennas, we shall use the vertical section of the T-cap dipole. The two horizontal wires at the top and bottom of the antenna, various called arms or legs, are each exactly 10' long in the sample. Hence, the total width of the antenna is 20'. This width falls well within the clear area that we should have for any type of vertical dipole.

If we need to make adjustments for obtaining resonance in subsequent arrays that use the T-cap dipole, we shall adjust the length of the legs of the T, thereby leaving the center vertical section intact. The dimensions for the basic T-cap dipole appear in **Table 2**, along with some basic performance data. Within that data, only the first section is immediately relevant for comparison with the full-length dipole. First, note the 22-degree TO angle. This value is higher than the value for the full-length dipole, but the T-cap vertical's feedpoint is considerably lower (about 0.16-wavelength above ground). Partly as a function of the lower feedpoint height and partly as a function of the vertical-element shortening, the gain of our T-cap dipole is about 0.4-dB lower than the gain of the full-length dipole. Yet the T-cap dipole, as set up in the sample model,

is nearly 30' lower in overall height, yielding what is for most amateur operators a much more manageable construction and maintenance situation.

## 2. T-Cap Vertical Dipole

Bot Ht feet	Top Ht feet	Length feet	T-Leg feet	Width feet
5.0	40.5	35.5	10.0	20.0

Performance over average soil

	Gain dBi	TO Angle degrees	Feed Impedance R +/- jX $\Omega$
1. No local ground improvement	-0.54	22	72.4 + 0.9
2. 4 34.4' AWG #12 radials buried 1' below surface	-0.50	22	73.0 + j2.4
3. 16 34.4' AWG #12 radials buried 1' below surface	-0.24	22	72.4 + j6.6
4. 64 34.4' AWG #12 radials buried 1' below surface	-.14	22	67.6 + j9.4
5. Wire-grid square, 70' by 70', 1' below surface	0.53	23	66.1 + j12.0

In the table, we also find some performance values related to improvements that we may make in the local ground immediately beneath the vertical dipole. When we think of local ground improvements together with virtually any vertical antenna, most amateurs immediately think of radials. However, unlike the radials of a monopole, the radials beneath a vertical dipole (either full length or shortened) perform no antenna-completing function.

Rather, they simply function to raise the conductivity of the soil immediately beneath the antenna. In cases 2 through 4 in the table, I created radial systems with the hub directly below the antenna. The 1/4-wavelength radials use AWG #12 wire buried 1' deep in the average ground. As the table shows, adding 4 radials amounts to wholly wasted effort, since the gain increase is only 0.04 dB. 16 radials provide a 0.3-dB gain increase, perhaps a marginal amount, considering the work involved. If radial installation is easy, we may increase the field to 64 radials and obtain nearly 0.7 dB gain increase. **Fig. 3** provides a view of the 3 radial field along with the T-cap dipole above them. You may estimate the installation work from the sketches.

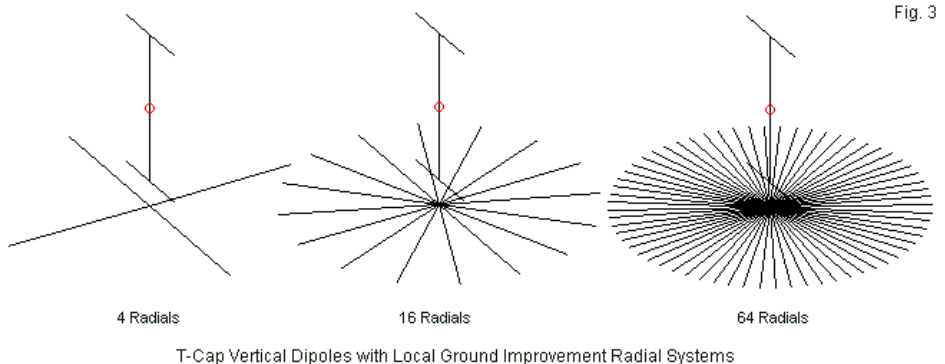

Note that none of the radial fields changes the TO angle of the elevation pattern. The TO angle is mostly a function of the far-field reflection zone, with is mostly well outside the radial limits. For the exercises, I did not change the antenna dimensions. Therefore, the

major influence of the fields appears in the feedpoint impedance listings. As the size of the radial field increases, the resistive component of the impedance decreases and the reactance becomes more inductive. However, none of the changes in cases 2 through 4 present any operational concerns.

The last case presents an alternative method of local ground improvement. Instead of using a radial system, I modeled a wire-grid system below ground to simulate laying a screen of some sort below the antenna. The screen is square and 70' on a side. **Fig. 4** overlays the 16-radial system on the screen to show the change in ground coverage in the screen corner region. (I used the 16-radials so as not to obscure the grid. However, the most relevant comparison would be between the screen and the 64-radial system.)



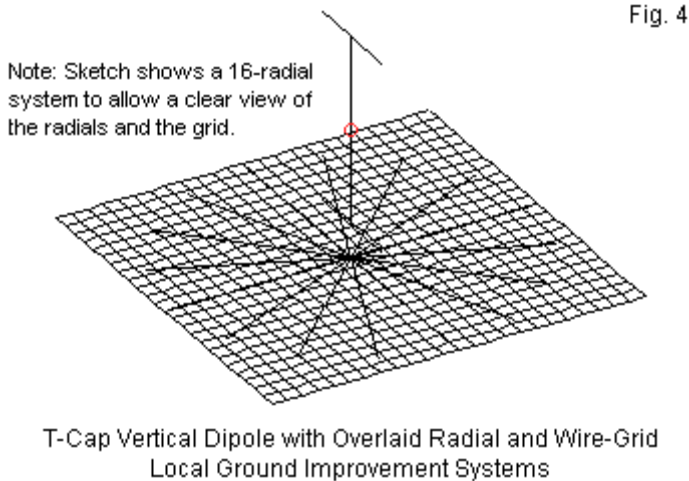

With the screen in place, we obtain almost 1.1 dB gain improvement over untreated soil, and about 0.4-dB improvement over the 64-radial system. The cost of the gain is a 1-degree increase in the TO angle and further drift in the feedpoint impedance. For antennas--like vertical dipoles--that do not require radials to function as the lower half of a dipole, screens may sometimes be the easiest and most effective means on improving soil quality immediately below the antenna. However, they do not provide that same benefits as living over very good soil, since the treatment does not also apply to the far-field reflection zone. For example, local area treatment may reduce ground losses below the antenna, but that results in a higher TO angle, because the improvement increases local reflection almost straight upward. The lower TO angles that we often associate with the same antenna

over very good soil results from improved soil conductivity at considerable distances from the antenna.

In the end, soil improvement is a matter for the antenna user to decide after measuring the anticipated performance improvements against the amount and cost of work involved in local ground treatment. For the remainder of these notes, we shall use untreated soil beneath the antenna, so that the performance values in case 1 in **Table 2** become the reference points for all that follows.

Before we leave the basic T-cap vertical dipole, we should introduce one more set of considerations. We are interested not only in the performance of any antenna at the test frequency, but also across the entire band. 40 meters is a wider (but not the widest) amateur allocation, with a 4.2% bandwidth. Some antennas will handle the entire band; others will not. A basic dipole--either full-length or T-capped--shows only a show change of gain across the band. The case-1 T-cap dipole, for example, changes gain by only 0.07 dB from 7.0 to 7.3 MHz. Note that our performance concerns include not only the SWR properties, shown in **Fig. 5**, but also such matters of forward gain and front-to-back ratio, both of which will become important as we add directionality to the basic dipole.

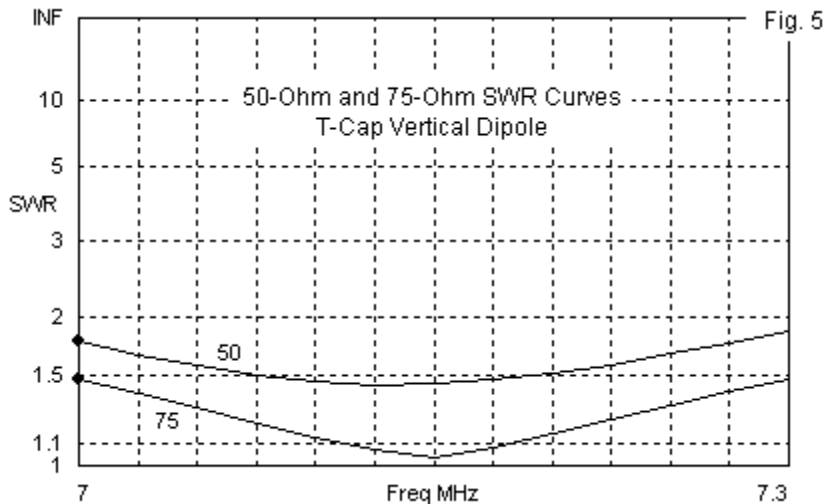

Although the resonant impedance of the basic T-cap dipole is in the vicinity of 75 Ohms, even the 50-Ohm SWR is below 2:1 from one band edge to the other. Hence, we may feed the dipole using either 50-Ohm or 70-Ohm coaxial cable. As usual, one should route the cable at right angles to the vertical dipole for as far as possible, providing supports so that the cable weight does not unduly stress the wire antenna. As well, I recommend the use of 2 common-mode current attenuators, one at the feedpoint to also serve as a balun, and the other at the entry to the operating building to attenuate any currents induced along the cable run.

## A Bi-Directional Pair of T-Cap Dipoles

Because many of the arrays to follow will use a pair of T-cap dipoles, we should spend a moment to see what happens when we place a pair of these dipoles at a spacing of  $1/2$ -wavelength (about 68.8') and feed them in phase. Because the in-phase fed pair of antennas will interact (or, otherwise put, exhibit mutual coupling), I extended the T arms to 10.31' each. As a result, the total array width, from outer T-tip to outer T-tip is about 89.4'. As shown in **Table 3** and the outline portion of **Fig. 6**, the array height above ground has not changed relative to using a single T-cap dipole.

### 3. 2 T-Cap Vertical Dipoles Separated $1/2$ - $\lambda$ and Fed In Phase

Each Dipole:					Total Array	
Bot Ht	Top Ht	Length	T-Leg	Width	Separation	Total Width
feet	feet	feet	feet	feet	feet	feet
5.0	40.5	35.5	10.31	20.62	68.78	89.4

#### Performance over average soil

Gain	TO Angle	Beamwidth	Feed Impedance	Feed System: 2 $1/4$ - $\lambda$ 70- $\Omega$ VF 1 Lines
dBi	degrees	Degrees	R +/- jX $\Omega$	Net R +/- jX $\Omega$
3.58	22	65.2	56.3 -1.8 (per dipole)	43.5 + j1.4

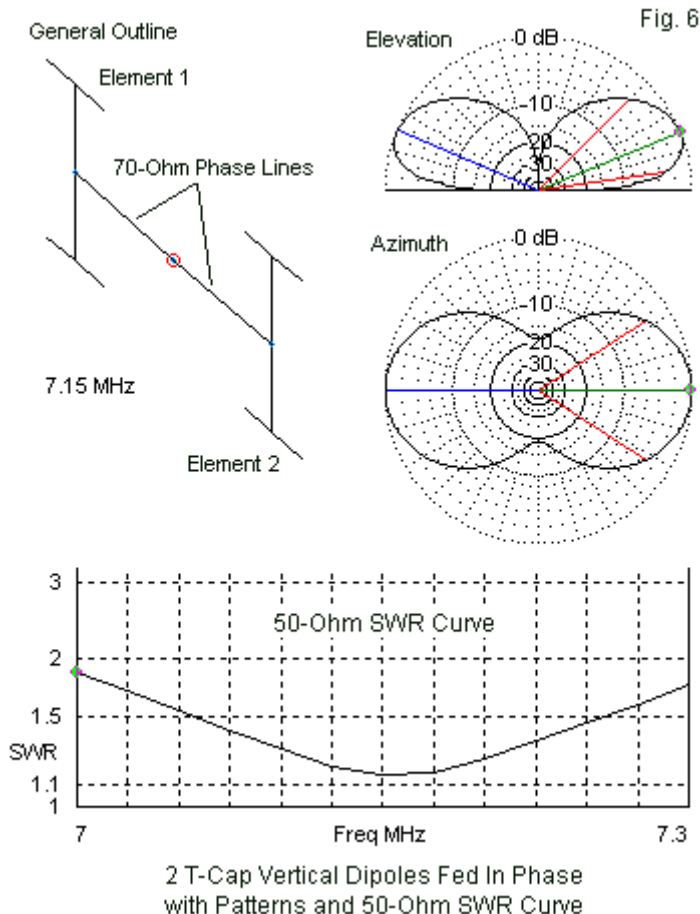

Perhaps the most surprising aspect of the array is the 4.1-dB gain improvement over a single T-cap vertical dipole. Of course, the

added gain comes at a cost in the available beamwidth, now down to about 62 degrees. Nevertheless, the array is no taller and only a bit wider than a half-square, but provides more gain. The gain that is competitive with a bobtail curtain. In fact, the in-phase-fed pair of vertical dipoles lies at the theoretical core of all SCV (self-contained vertical) antennas, since the basic versions--ranging from deltas to rectangles to half-squares, all place two elements in phase, but at a spacing limited by the single-wire, single-feedpoint configuration.

The independent feedpoint impedances of the two T-cap dipoles is about 56 Ohms. Therefore, we may equip the phased pair with a common feedpoint by using equal lengths of 70-Ohm feedline to a center point. Since the physical distance between each element's feedpoint and the center point is 1/4-wavelength, and since all 70-Ohm transmission lines have a velocity factor (VF) of well under 1.0, you may need to use 3/4-wavelength section to arrive at the required 100-Ohms at the junction, a value that becomes a good 50-Ohm match in a parallel connection. The lower portion of **Fig. 6** provides the modeled 50-Ohm SWR curve. The array covers the entire 40-meter band with an SWR value that is less than 2:1.

We shall not linger over the in-phase-fed pair of T-cap dipoles and their broadside bi-directional pattern. However, we shall occasion to mention them once more before we close our screening survey. Nevertheless, we should call to attention one more time the gain value produced by the pair of elements. The maximum gain in each direction will exceed the forward gain value that we may achieve from some of the more basic beams that we consider when thinking about a pair of T-cap dipoles and their best use.

## Parasitic Driver-Reflector Beams Using T-Cap Dipoles

For many operating needs, a front-to-back ratio of at least 10 dB may be more important than additions to the arrays forward gain. In such cases, we may create an endfire array using standard 2-element Yagi principles. In a Yagi with full-length elements, the reflector is normally longer and the driver normally shorter than a freestanding resonant dipole. In creating the driver for a useful Yagi-type beam, we may simply reduce the T-legs to an individual length of 9.6' (for a total element width of 19.2').

However, we shall not stop to develop a reflector for the T-cap array that uses a larger element. Instead, we shall simply load the reflector and use the same dimensions as for the driver. Reflector loading of a 2-element parasitic array normally does not reduce the forward gain, and it may actually improve the front-to-back performance over a full size reflector. **Table 4** supplies the dimensions of the array, which spaces the elements 21' apart. **Fig. 7** shows the outline and the radiation patterns that we might expect.

### 4. 2-Element Parasitic T-Cap Vertical Dipole Beam

Each Dipole					Spacing	Reflector Load	
Bot Ht	Top Ht	Length	T-Leg	Width	Driver/Reflector	Reactance	50-Ω VF 1 Shorted Stub
feet	feet	feet	feet	feet	feet	jΩ	feet
5.0	40.5	35.5	9.6	19.2	21.0	55	18.24

### Performance over average soil

Gain	TO Angle	Front-Back Ratio	Beamwidth	Feed Impedance
dBi	degrees	dB	Degrees	R +/- jX Ω
2.70	21	10.59	139.0	50.8 + j8.2

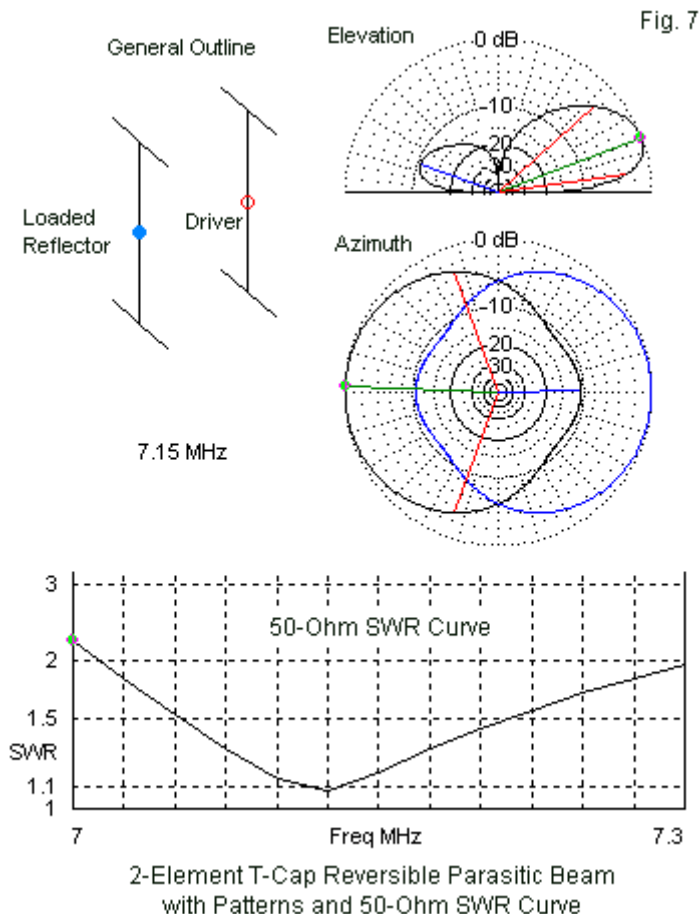

The azimuth plot overlays two patterns, one in each direction. One of the key advantages of loading the reflector is that--with very little



effort--we can reverse the beam's direction. The reflector called for a 55-Ohm load to achieve the desired pattern. Instead of using an inductor as the loading element, we may use a shorted length of feedline, in this case, 50-Ohm cable to match the feedpoint impedance of the driver element. The electrical length would be about 18.24', but the physical length will be the electrical length times the cable's velocity factor. Even a solid dielectric cable will yield a physical length of at least 12', so that cable running from each element can meet in the center of the 21' element spacing. Then, with a suitable remote switch, we can short one cable to make the inductively reactive load for the reflector and connect the other line to the main feedline. With a flip of the switch, we have reversed the beam's direction.

When we first encounter vertically polarized parasitic arrays, we are sometimes surprised by the facts that their gain is lower and their beamwidth is much greater than the patterns that we find in horizontal arrays using the same number of elements. The beam's gain value is about 3.3 dB higher than for a single T-cap dipole, but less than the bi-directional gain of the phase-fed pair of verticals. The beamwidth is nearly 140 degrees, providing very good coverage in each of the beams two possible directions. Although ground losses have a role to play in setting the gain of all vertical antenna types that are close to the ground, the vertical array's gain would not catch up to the gain of a horizontal counterpart until we reached a height above 20 wavelengths. The key factor in the gain and beamwidth difference that we get from rotating the beam 90 degrees along its real or virtual boom is a function of geometry. The arrangement of element tips restricts the beamwidth in the E-plane,

that is, in the plane of the elements. However, the H-plane has no such restrictive influence. Indeed, in free-space, H-plane patterns of a 2-element parasitic array look very much like the pattern of a single vertical dipole but displaced in the direction of the forward gain. A Yagi must have many elements (and be very long) before the H-plane beamwidth narrows significantly.

Nevertheless, the reversible 2-element vertical array with T-cap elements provides good service across the 40-meter band. As the 50-Ohm SWR curve at the bottom of **Fig. 7** shows, the array will cover most of the band with less than 2:1 SWR. However, we early on noted that our bandwidth concerns covered more than just the SWR. We are also interested in how well the antenna performs in terms of gain and front-to-back ratio. **Fig. 8** provides a partial answer to our questions.

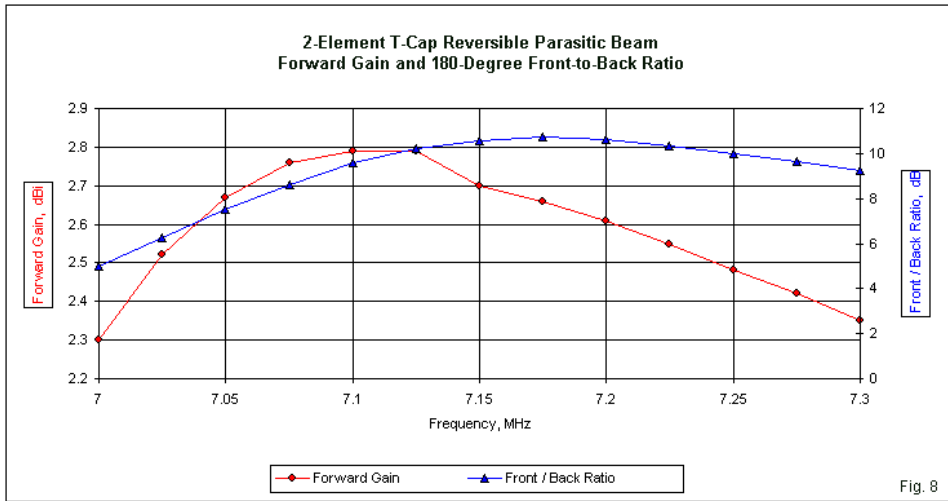

The gain curve in the figure shows a 0.4-dB range of forward gain value across the band, a value that we may consider fairly stable for such a wide amateur band using elements composed of relatively thin wire. In contrast, the front-to-back ratio remains above 10 dB only for a small portion of the band. However, it never drops below 5 dB. In fact, with careful adjustment of the reflector load, we may be able to center better the front-to-back curve for relatively similar performance at the band edges. A slightly higher load reactance--meaning a slightly longer length for the shorted stub--would likely do the job. Alternatively, we may favor either the CW-digital end of the band or the phone end of the band, according to our operating needs.

One limitation of the 2-element driver-reflector array is that we leave some portions of the horizon only weakly covered. It might be useful if we could cover the entire horizon with less than a 2-dB drop in gain around the 360-degree span--and at the same time maintain at least the forward gain that we obtained from the reversible 2-element array. To achieve that goal, we may think in triangles.

Suppose that we set up an equilateral triangle of T-cap vertical dipoles. We may designate the corner containing the driven element as the apex. The remaining corner will contain identical T-cap dipoles, but loaded to form reflectors. **Table 5** provides the dimensions and test-frequency performance data, while **Fig. 9** supplies a sketch and the radiation patterns.

#### 5. Triangular Parasitic Array of T-Cap Dipoles

Each Dipole					Triangle Dimensions	
Bot Ht	Top Ht	Length	T-Leg	Width	Side Length	Apex-Base Length
feet	feet	feet	feet	feet	feet	feet
5.0	40.5	35.5	9.5	19.0	30.64	26.53

#### Reflector Loads

Reactance	70- $\Omega$ VF 1	Shorted Stubs
JX $\Omega$	feet	
90	19.92	

#### Performance over average soil

Gain	TO Angle	Front-Back Ratio	Beamwidth	Feed Impedance
dBi	degrees	dB	Degrees	R +/- jX $\Omega$
3.20	21	14.97	134.2	71.6 + j6.8

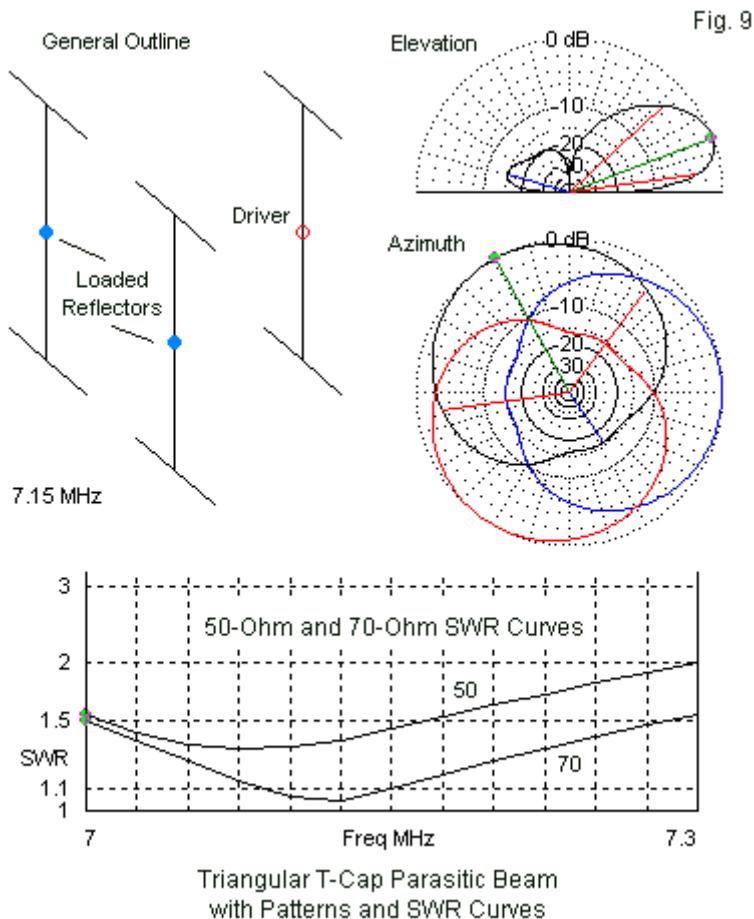

The T-legs are each 9.5' long for the individual dipoles. Each triangle side is about 30.6' long, yielding a distance between the

apex and the center of the triangle base of 26.5'. It does not matter how we orient the T-legs of the dipoles, so long as the legs form a straight line for each dipole. In the triangle shown--and other dimensions are also possible--each reflector dipole requires a  $j90$ -Ohm load. We shall again use shorted transmission-line stubs as the source of the required inductive reactance. Since the driver impedance is close to 70 Ohms, we shall use 70-Ohm lines, which require a 19.9' electrical length, with physical shortening that depends on the VF of the line used in the assembly. We shall bring the stubs to a center point within the triangle for switching. At any time, one of the stubs will actually be an extension of the main feedline to the driver, while the switch to form the required reflector loads shorts the other two lines.

The system gain is about 3.2 dBi, about 0.5-dB higher than for a standard 2-element parasitic array and about 3.7-dB higher than a single T-cap vertical dipole. The 15-dB front-to-back ratio is also several dB higher than we found for the 2-element parasitic beam. With its higher gain, the triangle shows a beamwidth that is about 5 degrees narrower than the beamwidth of the simpler beam. Perhaps the key advantage of the triangle is its ability to cover the entire horizon with only a 2-dB gain deficit at the overlap points between the forward lobes of the beam in each of its positions. Although the switching may be more complex for the triangle than for the reversible beam, the electronics are simple and cheaper than a rotator.

The lower portion of **Fig. 9** shows the 50-Ohm and 70-Ohm SWR curves for the array. A 50-Ohm feedline from the switch junction to

the equipment will be satisfactory if SWR values close to 2:1 are satisfactory at the band edges. However, a 70-Ohm line will reduce the maximum SWR value to about 1.5:1 at the band edges. With respect to the gain and front-to-back performance across the 40-meter band, **Fig. 10** supplies the appropriate sweep data.

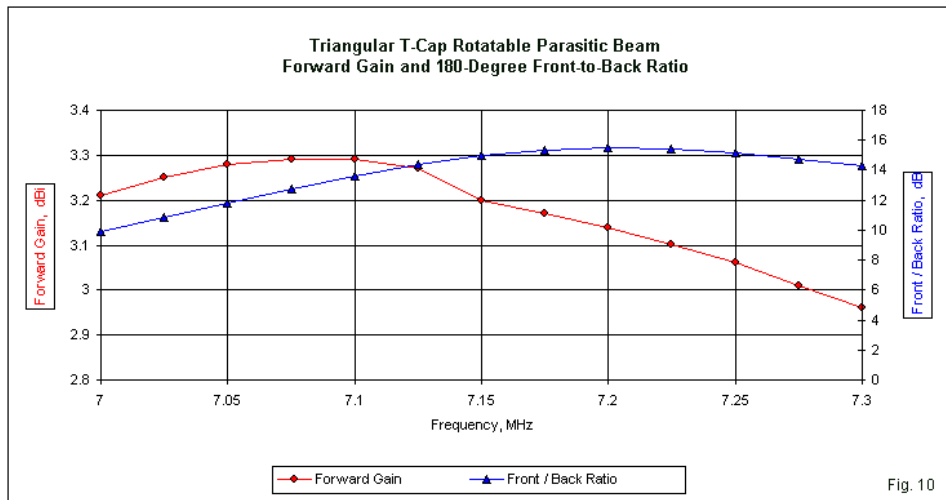

The performance bandwidth of the triangle is generally similar to the performance bandwidth of the reversible array, but with a smaller range of value change across the band. The gain varies by only about 0.2 dB. The front-to-back ratio remains at 10 dB or more for the entire band. The band-edge values may be equalized by slight adjustments to the load values, that is, the length of the shorted stubs. With the smaller range of performance change over the 300 kHz of amateur allocation (in the U.S.), one may design a

triangle for whole-band use and expect only small deficits at each band edge.

## A 2-Element Phased Beam Using T-Cap Dipoles

Obtaining the maximum possible front-to-back ratio from 2 elements is difficult if not impossible using parasitic techniques and 2 vertical elements that are close to the ground. However, it is easily possible to improve the front-to-back performance and to obtain a nearly cardioidal pattern by phasing 2 T-cap dipoles in an endfire arrangement. In fact, we may do so using commonly available feedline materials, although we may have to do some experimentation to find the optimal cable for the task.

Experimenting with modeling software is more rapid and less costly than experimenting with lengths of actual cable.

**Table 6** profiles the phased array that uses two standard T-cap dipoles with 9.6' T-legs and a spacing of 21' (the same spacing used for the reversible parasitic array). Both dipoles use identical construction. The phase line uses two separate lengths that reach a junction where we shall connect the main feedline. The section to elements 1 in **Fig. 11** is 084' of RG62, 93-Ohm line with a VF of 0.84. Hence, the electrical length is 1'. The line does NOT undergo a half twist or reversal. However, the line from the junction to the rear element--from the same material--does undergo a reversal. It is 21' physically or 25' electrically.



## 6. 2 Phased End-Fire T-Cap Elements

## Each Dipole

Bot Ht	Top Ht	Length	T-Leg	Width	Spacing
feet	feet	feet	feet	feet	feet
5.0	40.5	35.5	9.6	19.2	21.0

Phasing Lines 93- $\Omega$ , VF 0.84

## Feed-Element 1 (forward)

Length	Normal/ Reversed
feet	
0.84	Normal

## Feed-Element 2 (rear)

Length	Normal/ Reversed
feet	
21	Reversed

## Open Beta Stub

50- $\Omega$  VF 0.78

Length
feet
14.26

## Performance over average soil

Gain	TO Angle	Front-Back Ratio	Beamwidth	Pre-Match	Post-Match
dBi	degrees	dB	Degrees	Feed Impedance	Feed Impedance
				R +/- jX $\Omega$	R +/- jX $\Omega$
2.92	21	26.19	145.2	22.5 + j23.6	47.2 + j0.1

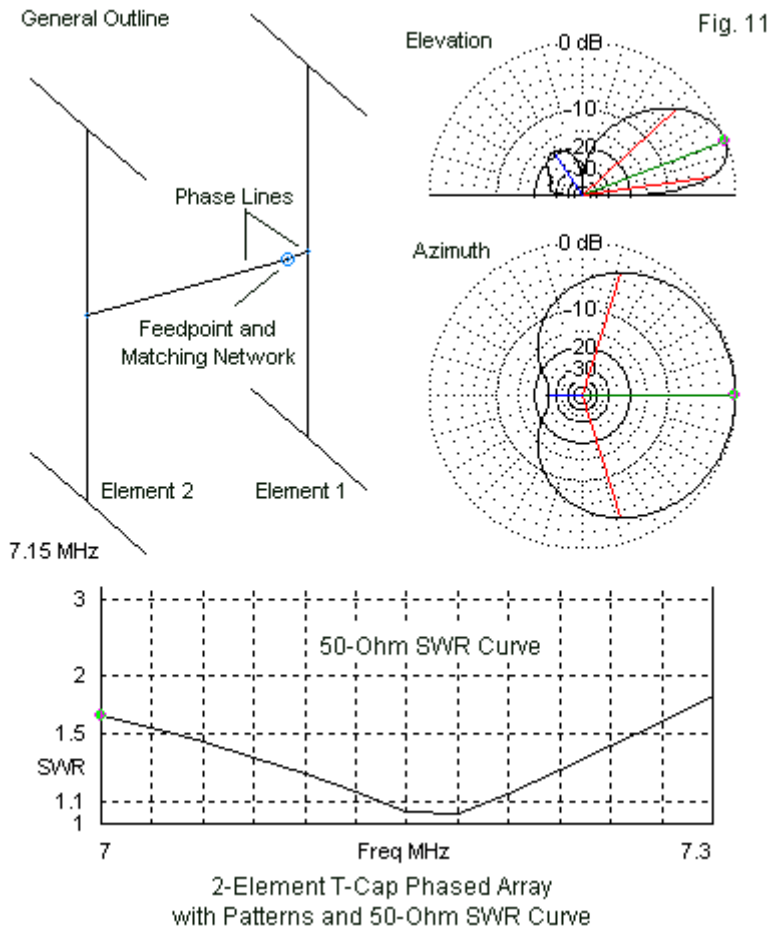

The forward gain of the array is comparable to the gain of the reversible parasitic array. However, the front-to-back ratio climbs to

over 26 dB at the design frequency. As well, the beamwidth increases to about 145 degrees, providing wide coverage in this essentially mono-directional array. The rearward quadrants of this array promise to be exceptionally quiet.

The cost of this type of performance lies in the odd feedpoint position before we add matching components. The low impedance has a high inductive reactance. However, the values are nearly optimal for a beta match, so long as we use an open or capacitively reactive stub across the feedpoint terminals. 14.3' of 50-Ohm VF 0.78 cable or its equivalent provides the necessary shunt component for the beta L-network that yields an impedance close to 50 Ohms. With the beta component in place, the SWR curve in **Fig. 11** shows well under a 2:1 SWR value at the band edges.

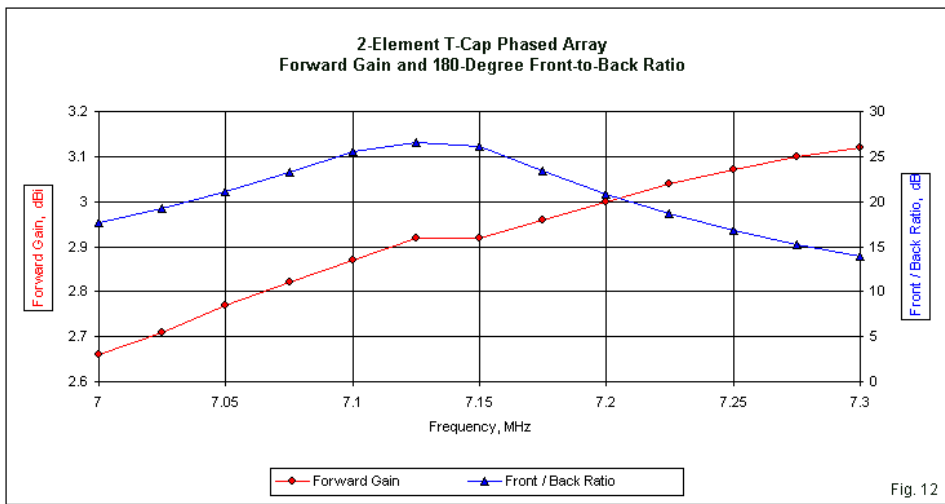

**Fig. 12** provides sweep data for the phased array relative to forward gain and front-to-back ratio. The gain rises steadily across the band over a 0.4-dB range. The front-to-back ratio peaks near the middle of the band and decreases to about 15 dB at the band edges. Compared to parasitic arrays, the whole-band front-to-back performance of the phased array rates very highly. Perhaps the major drawback to phasing is that the array does not succumb easily, if at all, to reversing direction.

## Screen Reflectors and the T-Cap Driver

Screen or planar reflectors have been used since the 1920s in major arrays. Indeed, in their early years, some called them billboard reflectors. A solid surface properly sized will reflect radio waves in ways that are analogous to the reflection of light from a flat mirror. We find them in wide use in dipole arrays for short-wave broadcasting and in a wide variety of UHF antennas. More recently, I have recommended their use beneath a number of NVIS antennas to increase gain, essentially by elevating the quality of the reflective plane beneath the antenna. In fact, the wire-grid ground improvement technique noted earlier represents a different application of the same technology.

A wide range of experience shows that planar or screen reflectors are most effective in improving directional gain when they exceed the dimensions of the driver element by between 0.45 and 0.55 wavelength both horizontally and vertically. We can achieve this goal horizontally with our T-cap vertical dipole driver, but any screen reflector will be vertically challenged. The ground, of course,

is one limit, preventing the reflector from extending below the driver by the desirable amount. Vertically, we shall be limited as well by some of the height restrictions that we set for this project. If we limit ourselves to a 50' top height, the forward gain will be only a little greater than the gain of the reversible beam. A top height of 100' yields perhaps a half-dB more gain than a 70' height. Therefore, for the comparisons that we shall show, the height of the screens will run from just above ground level to 70'. One might hang such a screen between two widely separated towers that support antennas for higher amateur bands.

The optimum width turns out to be just about 140', which is 1 wavelength at the test frequency (7.15 MHz) and a half-wavelength on each side of the driving dipole. Screen reflectors do not have to be solid surfaces to act like solid surfaces in the HF range. Chicken-wire fencing and open-weave materials will appear solid to 40-meter energy. The model for the screen-reflector array uses a wire-grid, as shown in **Fig. 15**. The dimensions and performance data appear in **Table 7**.

#### 7. T-Cap Dipole Driver with Wire-Grid Planar (Screen) Reflector

Dipole Driver					Wire-Grid Screen			
Bot Ht	Top Ht	Length	T-Leg	Width	Spacing to Reflector	Side-Side Length	Top Height	
feet	feet	feet	feet	feet	feet	feet	feet	
5.0	40.5	35.5	9.66	19.32	35.0	140	70	
Performance over average soil								
Gain	TO Angle	Front-Back Ratio		Beamwidth	Feed Impedance			
dB <sub>i</sub>	degrees	dB		Degrees	R +/- jX Ω			
4.67	19	13.22		83.4	81.2 + j0.6			

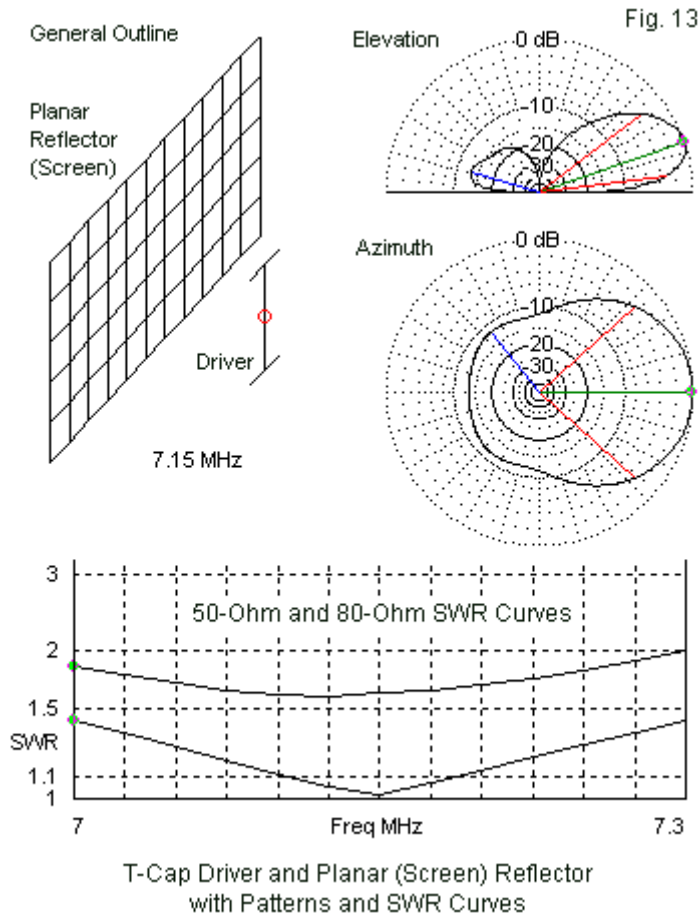

The selected distance from the driver to the reflector is 35' for an array using a single T-cap dipole driver and a 140' by 70' screen

reflector. You may ground the screen bottom wires with no effect on performance, but with a considerable affect on safety. The driver uses 9.66' T-leg lengths for an 80-Ohm resonant impedance. With a planar reflector, you may vary two items to set a feedpoint impedance: the dipole dimensions and the spacing from the reflector. In general, closer spacing produces lower feedpoint impedance levels, but narrower operating bandwidths. Each space adjustment will change the coupling between the reflector surface and the driver, requiring adjustments to the T-leg lengths to return to resonance.

The chief merits of the planar reflector array are forward gain and operating bandwidth, when we compare the results to the reversible parasitic array. The top height of the reflector limits the front-to-back ratio to about 13 dB. A top height of 100' would have added another dB to the ratio, while a more ideal (and unrealistic) height of 140' would add a further dB or two. The array's forward gain is close to 4.7 dBi, about 1.8 dB higher than the 2-element parasitic array. The forward gain comes at the expense of the beamwidth, which is down to 83 degrees, about 50 degrees narrower than the beamwidth of the parasitic beam.

Despite the 80-Ohm resonant feedpoint impedance at the design frequency, the 50-Ohm SWR curve in **Fig. 13** reveals a very low rate of impedance change across the 40-meter band. That curve shows less than 2:1 SWR at the band edges. The lower 80-Ohm curve shows less than 1.5:1 SWR at the band's upper and lower limits. The remaining prime operating parameters are equally slow to change, as shown in the sweep data in **Fig. 14**.

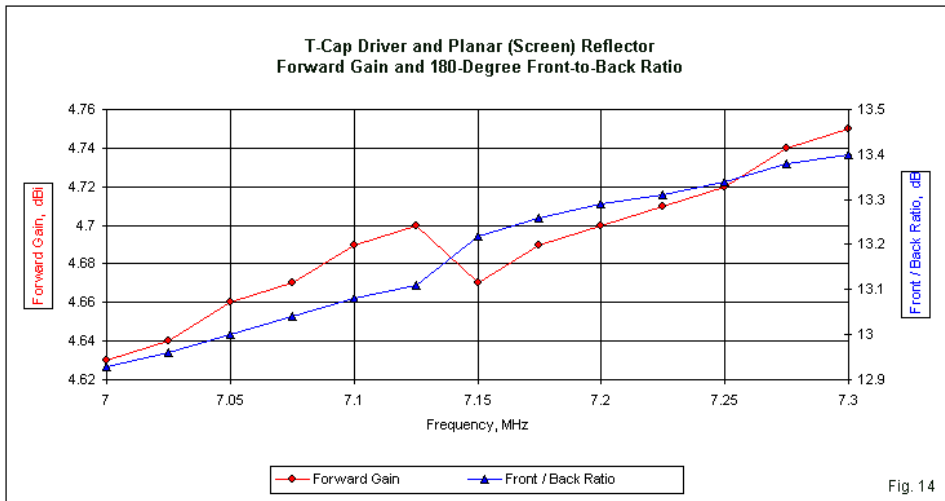

The gain across 40 meters changes by only about 0.1 dB, while the front-to-back ratio varies by just over 0.5 dB. It is possible to design driver elements with an inherently wider bandwidth and to use the array to cover both 40 and 30 meters with very little change in performance.

One common method of constructing a screen is to use a series of wires polarized as the driver element. To sample that option, I reconstructed the screen reflector using 29 AWG #12 wires at 5.0' intervals. The overall horizontal and vertical screen reflector dimensions remained the same. Doubling the wire size (to AWG #6) yielded no performance improvements. The only other change relative to the wire-grid screen was a 3' increase in the spacing of the driver from the reflector, as shown in the dimensions in **Table 8**.



## 8. T-Cap Dipole Driver with Vertical-Wire Screen Reflector

Dipole Driver						Wire-Grid Screen	
Bot Ht	Top Ht	Length	T-Leg	Width	Spacing to Reflector	Side-Side Length	Top Height
feet	feet	feet	feet	feet	feet	feet	feet
5.0	40.5	35.5	9.66	19.32	38.0	140	70

Note: Vertical-wire screen consists of 29 AWG #12 copper wires at 5' intervals.

## Performance over average soil

Gain	TO Angle	Front-Back Ratio	Beamwidth	Feed Impedance
dBi	degrees	dB	Degrees	R +/- jX $\Omega$
4.15	19	10.85	100.4	86.4 + j1.2

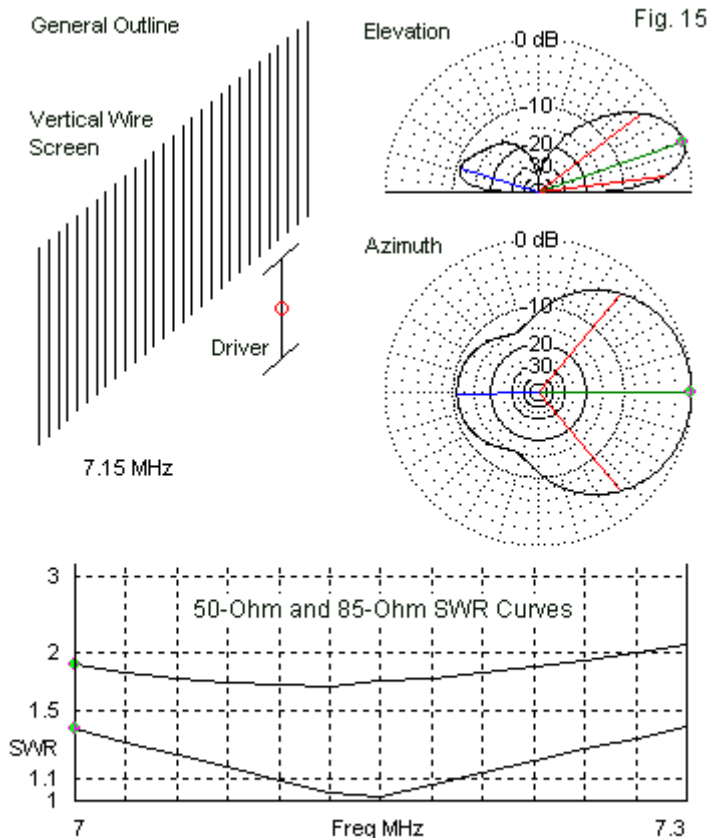

T-Cap Driver and Vertical Wire Screen Reflector  
with Patterns and SWR Curves

As the data and the patterns in **Fig. 15** show, the vertical-wire reflector is not quite as effective as the wire-grid version. Gain

drops by about a half dB, while the front-to-back ratio decreases by well over 2 dB. Both decreases are indications that the wire version of the screen requires a taller top height or is perhaps "leakier" than the wire-grid. As well, the resonant impedance is 5 Ohms higher and does not produce 50-Ohm SWR values under 2:1 without further matching. However, the lower 75-Ohm SWR curve in the graph does track the wire-grid's 80-Ohm SWR curve very well.

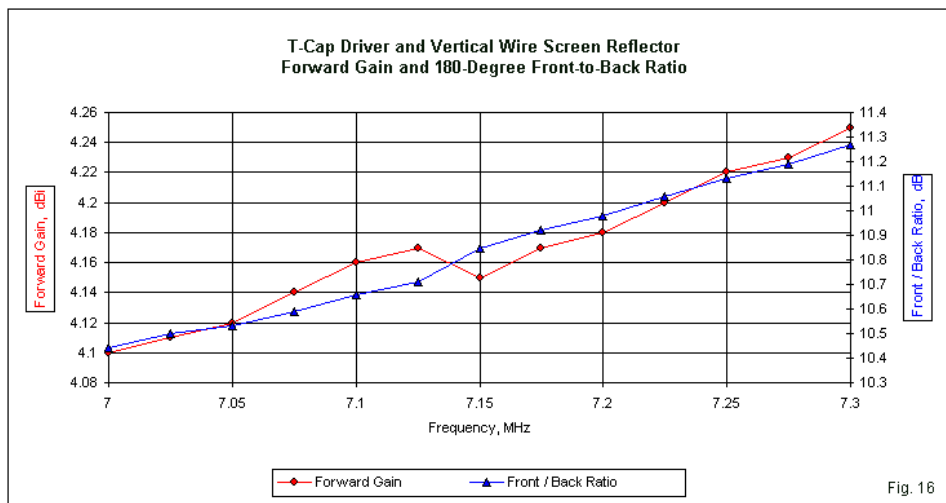

The sweep information in **Fig. 16** shows the same broad curves for both the forward gain and the front-to-back ratio. The gain range is about 0.15 dB across the band, while the front-to-back ratio changes by only 0.8 dB. Even with somewhat lesser performance than the wire-grid reflector, the vertical-wire screen still enjoys a

considerable advantage over a parasitic reflector with respect to broadband characteristics.

To compensate even if only partially for ground losses, one may tilt the reflector back as viewed from bottom to top. Using an 11' tilt (35' at the bottom and 46' at the top for the distance between the driver and the vertical-wire reflector), it is possible to add a few tenths of a dB to the forward gain and a similar amount to the front-to-back ratio. However, the exercise has its own consequences, as revealed in the overlaid patterns of **Fig. 17**.

Elevation Plots: T-Cap Driver with  
Vertical and Tilted Wire Screen  
Reflectors

7.15 MHz

Blue: Vertical Reflector  
Black: Reflector Wires  
Tilted Back 9 Degrees

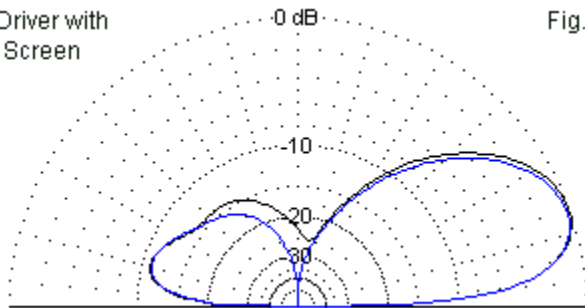

The peak gain lines both forward and rearward are virtually indistinguishable in the patterns. However, note the increased high angle radiation, especially in the rearward lobes. As well, radiation directly overhead to the driver has also increased. In the end, a vertically oriented screen appears to yield the best combination of performance and patterns.

Earlier in these notes, I promised a second look at the in-phase-fed pair of T-cap dipoles spaced 1/2-wavelength apart. The dipole pair produced a bi-directional pattern with a maximum gain that was over 4 dB stronger than a single T-cap dipole. Since we can readily feed the pair of dipoles from a single feedpoint, using a pair of equal-length lines, we might wonder what would happen if we place the broadside array in front of a screen reflector.

Ideally, the screen should be over 200' wide. Understanding that we lose performance as we shrink a screen below its ideal proportions, let's continue to use the smaller 70' by 140' wire-grid screen. With the screen 40' behind the driver, the T-legs of each dipole are 10.16' long, longer than for a single dipole driver, but slightly shorter than the T-legs on the bi-directional array. As shown by the dimensions in **Table 9** and the outline sketch in **Fig. 18**, we lose a good bit of the horizontal screen extension that optimizes performance. Nevertheless, the performance is noteworthy.

## 9. In-Phase T-Cap Dipole Drivers with Wire-Grid Planar (Screen) Reflector

Each Dipole Driver					Element	
Bot Ht	Top Ht	Length	T-Leg	Width	Separation	Total Width
feet	feet	feet	feet	feet	feet	feet
5.0	40.5	35.5	10.16	20.32	68.78	89.1

Wire-Grid Screen		
Spacing to Reflector	Side-Side Length	Top Height
feet	feet	feet
40.0	140	70

Performance over average soil					
Gain	TO Angle	Front-Back Ratio	Beamwidth	Feed Impedance	
dBi	degrees	dB	Degrees	R +/- jX $\Omega$	
4.67	19	13.22	83.4	81.2 + j0.6	

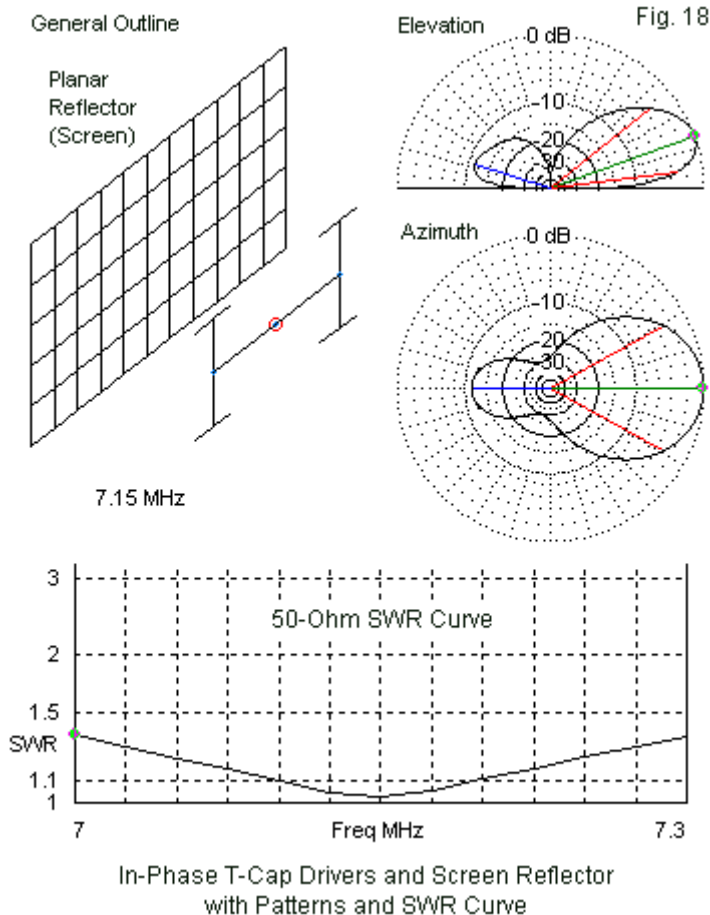

The 6.95-dBi forward gain value for the array may require some perspective. First, the value is almost 2.3-dB higher than the gain

we obtain from a single driver and the same reflector. A sign that the screen is less than optimal in size comes from the fact that the screenless bi-directional array produces a gain value that was 4 dB greater than a single T-cap dipole. Nevertheless, the phased dipole array and screen produce almost 7.5-dB gain relative to a single T-cap omni-directional dipole. The forward beamwidth is down to 58 degrees, dictating careful aiming of the array.

The front-to-back ratio is not outstanding, at about 11.4 dB, another sign of using a small screen reflector. Because the unmatched feedpoint impedance of each dipole is in the vicinity of 90 Ohms, we may run equal lengths of RG-62 (VF 0.84) to a center point between the dipoles and obtain a net impedance of 48.9 Ohms. As the 50-Ohm SWR curve shows, the array easily covers 40 meters with a maximum SWR that is less than 1.5:1.



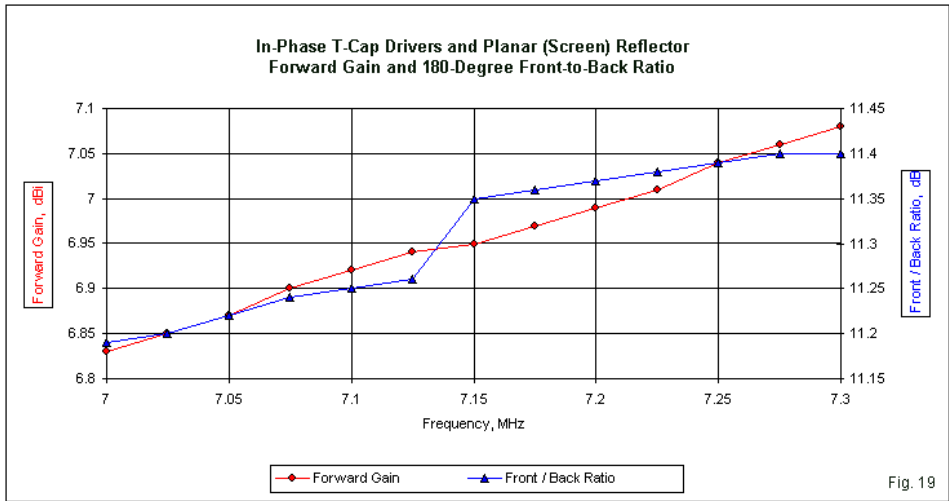

As the sweep data in **Fig. 19** reveals, the dual-dipole-driver array is as stable across 40 meters as the other sample screen-reflector array. Both the gain and the front-to-back ratio show changes of just over 0.2 dB across the band.

The construction of a screen-reflector is the most difficult portion of the overall project. Therefore, one may well wish to place drivers on either side of the screen for reversible service using separate feedlines all of the way to the equipment location. Whichever driver is in use (whether single or double), the inactive one will remain invisible due to the screen's reflection characteristics. Screen reflector arrays may not be for everyone, but they may serve a few 40-meter operators.

## Conclusion

We have not only surveyed comparatively the performance of vertical antennas and arrays on 40 meters, but we have added screen reflector arrays to the list that we normally see. This last group of arrays presents serious construction challenges, but offers in return increased gain over the values that we may obtain from parasitic arrays.

All of the driving elements in our comparisons have used AWG #12 copper wire in a T-cap arrangement that extends from 5' to 40.5' above average ground. We changed the length of the T-legs to obtain a resonant feedpoint impedance. The T-cap dipoles provide a uniform element length to help validate the comparisons. Although scarcely longer than 1/4-wavelength, the T-cap dipoles lose very little performance relative to the reference full-length wire dipole with which we began these notes.

Just because we cannot obtain the gain level of a phase-fed dipole pair with a screen reflector does not relegate the intermediate designs to uselessness. Indeed, many operators use T-cap and similar 40-meter vertical antennas with surprisingly good results. The parasitic arrays offer reversibility and even--with the triangle--full horizontal coverage at the flip of a switch. For maximum front-to-back ratio, the phased array is difficult to surpass, even though it uses no complex networks to achieve a nearly cardioidal pattern.

By setting the entire range of vertical arrays on common ground at a common frequency with common construction, you may gather a

more precise sense of the benefits and costs as you increase the complexity of a vertical array. Virtually all of the designs will scale directly to 30 meters, although bandwidth there is not a major concern beyond the realm of allowing rather casual construction without incurring performance losses. Scaling to 80 meters is also possible, although for most amateurs, the resulting element sizes may prove to be prohibitive. A T-cap dipole of the present design will extend from about 10' to about 81' at the top, depending on the precise frequency to which one scales the design. The T-legs can be trimmed for resonance if you stick with the AWG #12 wire rather than doubling its diameter. If the amount of trimming is not too great, adjusting only the lower T-legs will not disturb the centering of the feedpoint to any significant degree. (The presence of ground below the bottom of the antenna and essentially free space above the top already disturbs the balance that we presume when we physically center the feedpoint on a vertical dipole. Common-mode current attenuation devices are necessary adjuncts to any of these arrays.)

These notes have focused on performance comparisons and provided very few construction notes. Building any of these arrays, from the simplest to the most complex, will be an exercise in making use of available supports and in using what nature or prior antenna construction provides. In virtually all cases, the result will be far less expensive than a strong tower able to hold the weight of a horizontal beam that shows higher-angle elevation lobes and questionable operating bandwidth.

## Chapter 42: Wire Elements in Lower HF Arrays

**W**ire beams are commonplace in the lower HF region. They have some uses at HF as well, for example, in LPDAs. In both cases, we sometimes fall into the belief that the wire array has all of the gain and performance of a comparatively similar array made from fat tubular elements.

Of course, that belief is simply false. A reduction in the diameter of elements of the proportions of a move from a fat tube to a skinny wire reduces not only the operating bandwidth (sometimes), but as well reduces the inter-element coupling that is critical to deriving full performance from a beam. For example, standard LPDA calculations make use of the element length-to-diameter ratio in determining element lengths, but little has been noted about the lowering of gain in moving from fat to skinny elements. Even a beam like the LPDA, that is utterly dependent upon phasing connections, remains equally dependent upon inter-element (mutual) coupling, and that coupling decreases with decreases in element diameter for a given Tau and Sigma.

In many cases, tubular elements cannot be used due to their length and/or weight. Hence, the builder is forced to use wire. However, he need not be confined necessarily to reduced performance. I have shown in a couple of places a method for using wire elements that retain the performance of fatter tubular elements.

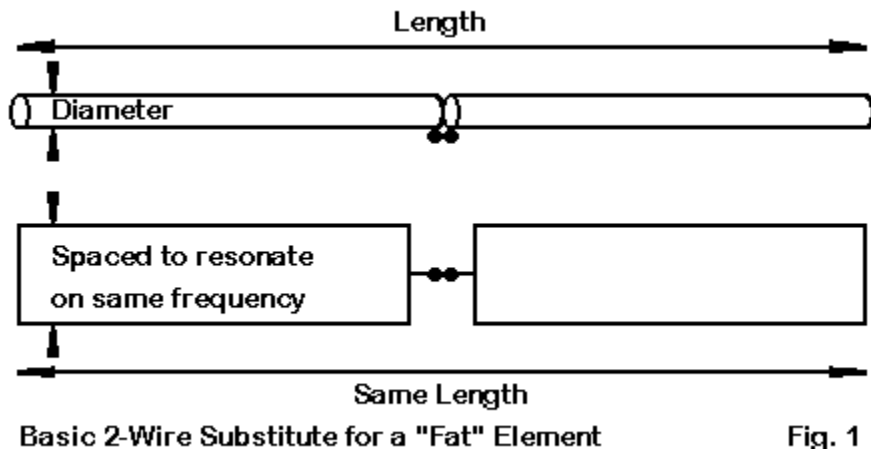

Basic 2-Wire Substitute for a "Fat" Element

Fig. 1

The technique is quite straight forward, as indicated by **Fig. 1**. For each element of a design originally created for single fat elements, create a double wire of the same length. Then, most likely through modeling (although field testing will also work), adjust the wire spacing so that the element is self-resonant on the same frequency as the original tubing element. The required spacing will vary with the wire size used. If a modeling approach is used to estimate the spacing, there are a few constraints that we shall look at further on.

It turns out that this arrangement works well for smaller diameter tubing equivalencies--say, up to 1 inch or 25 mm. For larger tubing, we encounter some limitations. The average tubing size--even in elements that start out at the element center as quite sizable--ends

up quite modest even in lower HF beams. You can check out the equivalent uniform diameter for almost any tapered-diameter element on NEC-2 programs having Leeson corrections by looking at the substitute elements used in the actual NEC calculations. Access to these substitute elements is available in EZNEC and similar programs.

However, we sometimes scale up array sizes from proven upper HF designs. Proper scaling requires that we increase all dimensions, including the element diameter, if we are to have what amounts to a true scaling. And only by a true scaling can we assure that the array will perform at the lower frequency to the level it promises at the higher frequency.

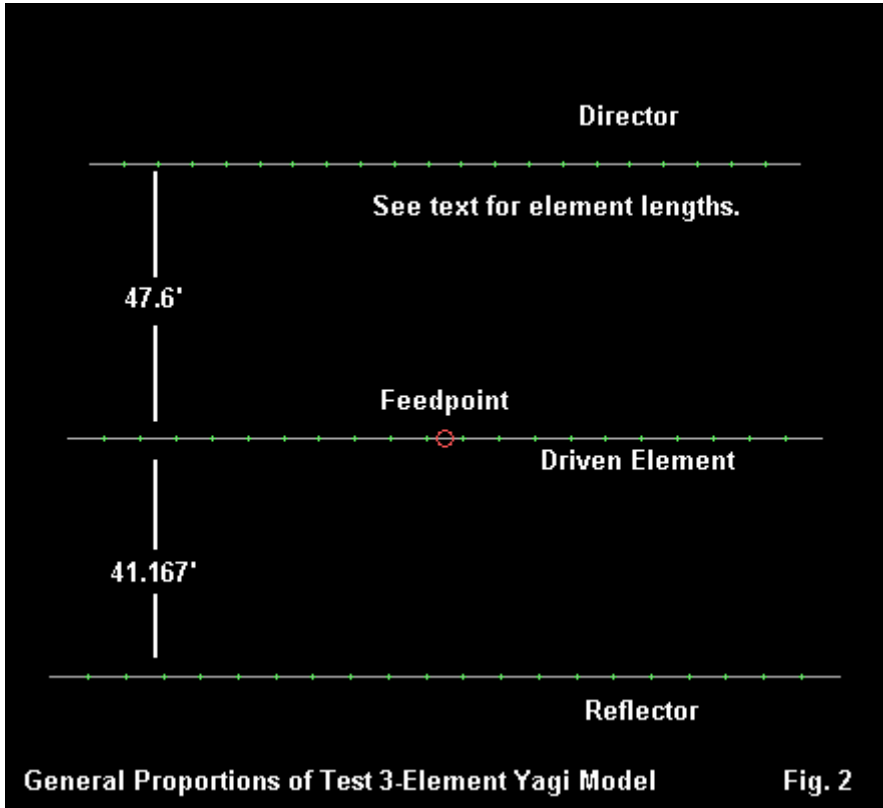

I had occasion to go through this exercise with a 3-element 20-meter beam adapted from a K6STI design. The exercise was initially theoretical, so I was not the least troubled by the resultant 4" diameter elements that emerged in the 80-meter model. **Fig. 2** shows the basic outline of the Yagi, which will become the center of attention in what follows. Here is a table of dimensions.

```

3-Element Yagi: 3.6 MHz: 4" diameter elements
Element      Element Length (ft)      Spacing from Reflector (ft)
Reflector    136.08                    ----
Driver       129.94                    41.167
Director     122.26                    88.767

```

Wondering what the antenna might do if made from wire, I recreated it from 0.1" diameter wire. This diameter is between #12 and #10 AWG. The conversion required some proportional lengthening of elements to achieve a coincidence of maximum front-to-back ratio and driver resonance. The element spacing was retained, and only the element lengths were changed. The resulting wire beam had these modeling specifications.

```

3-Element Yagi: 3.6 MHz: 0.1" diameter elements
Element      Element Length (ft)      Spacing from Reflector (ft)
Reflector    138.40                    ----
Driver       132.40                    41.167
Director     124.60                    88.767

```

Both antennas were modeled as copper elements in free space for comparisons. For the design frequency of 3.6 MHz, the results were interesting, to say the least.

```

NEC-4 Modeled Performance: 3-Element Yagis: 3.6 MHz
Model      Gain      F-B Ratio      Feedpoint Z      Efficiency
           dBi       dB             R +/- jX Ohms    %
4"         8.14      27.3           25.5 - j 0.9     99.81
0.1"      7.06      19.9           43.3 - j 2.9     95.87

```

Using wire reduced gain by over 1 dB and the front-to-back ratio by about 7 dB. The feedpoint impedance increases nearly 70%, much more than the increased wire losses would indicate. The 4% differential in efficiency is not large enough to account for the



source impedance increase. (NEC recognizes only wire material losses and spot load and other network losses in calculating efficiency. The latter will not be relevant to this exercise. Efficiency figures can be useful reference points, so long as we do not try to use them to account for every gain or loss in performance when comparing designs.)

If we use a current source of 1.0 at a phase angle of 0.0 degrees, we can gain further insight into the comparative performance of these arrays. We simply need to look at the element center current magnitudes and phase angles for the reflector and director elements for both beams.

```
NEC-4 Modeled Element Currents: 3-Element Yagis: 3.6 MHz
Model          Reflector I          Director I
              Magnitude    Phase    Magnitude    Phase
4"             0.405         143.5    0.601        -134.0
0.1"          0.414         126.1    0.456        -119.2
```

Since the elements are both parasitic, the differential in current magnitudes and phase angles is reflective of the difference in mutual coupling between the elements and the driver. If the current values for the 4" model are to be considered as more ideal, then the values that appear on the elements of the 0.1" model are considerably off target.

In fact, the wire version of the array might require considerable redesign to peak its performance, including adjustments to element spacing and length. This fact is revealed in frequency sweeps of both antennas from 3.55 through 3.65 MHz.

### 3-Element 80-Meter Yagis Gain vs. Element Diameter

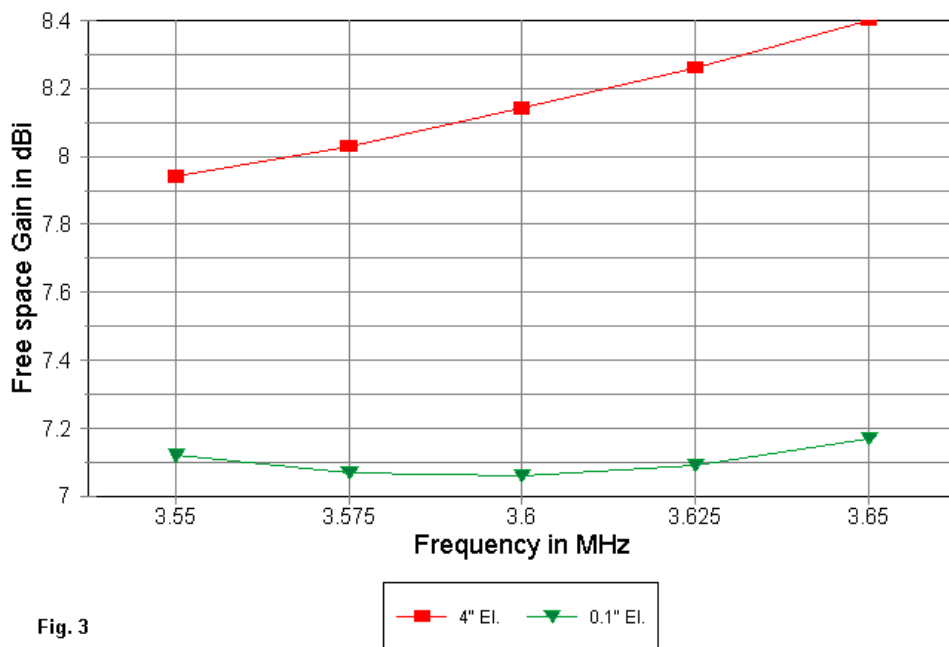

Fig. 3

**Fig. 3** shows the modeled free-space gain curves for both antennas. The 4" model shows the gain curve across the modeled passband that we have come to expect from high performance 3 element Yagis: a modest but continuous increase of gain with frequency. In contrast, the wire model shows the lowest gain at the design frequency. This dip is indicative antenna operation at a

different portion of the potential gain curve--somewhat lower in frequency than the corresponding curve positions for each of the 4" model gain numbers.

### 3-Element 80-Meter Yagis F-B Ratio vs. Element Diameter

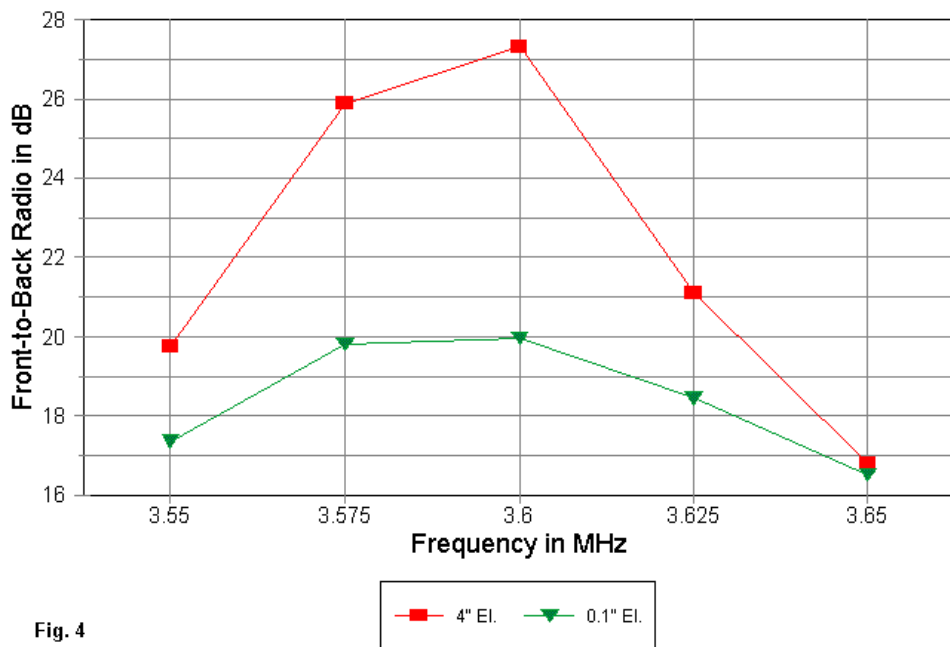
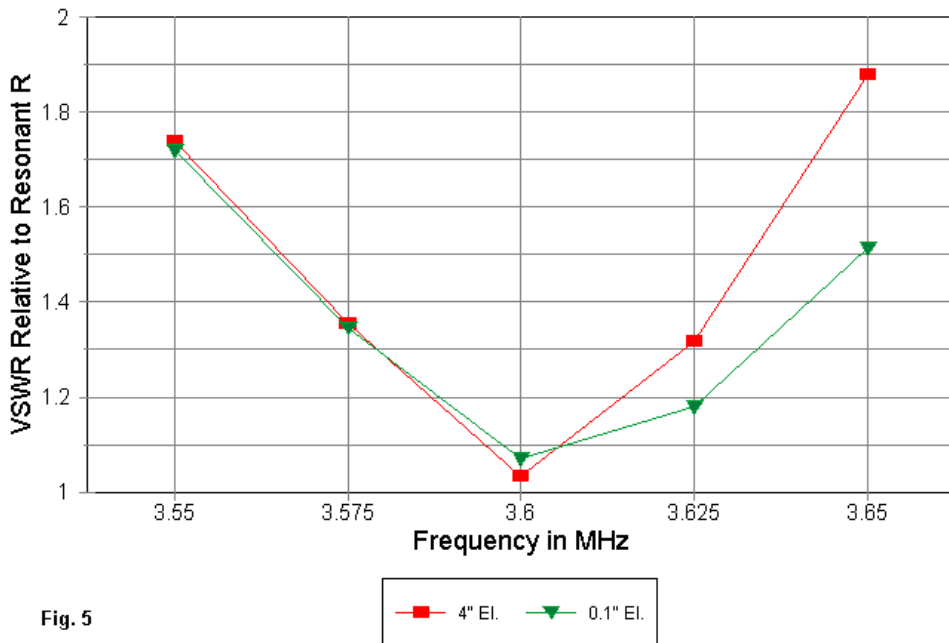

Fig. 4

However, as shown in **Fig. 4**, the front-to-back peak has been sustained at or just below the design frequency. In this aspect of design, the 4" model curve encompasses the wire model curve.

### 3-Element 80-Meter Yagis VSWR vs. Element Diameter



The wire model actually has a wider operating VSWR bandwidth than the 4" model, as shown in **Fig. 5**. The wider VSWR bandwidth results in part from the higher resonant source resistance, so that

equal amounts of reactance have a lesser effect on the SWR in terms of increasing its value. In fact, the wire model reactance from one passband limit to the other is only about 37% greater than that for the 4" model (40.3 vs. 29.5 Ohms), while the source resistance has climbed by 70 percent (43.3 vs. 25.5 Ohms). Hence, relative to the individual resonant source resistances, the wire beam will permit operation over more of 80 meters.

Despite the wider operating bandwidth, my aim was to see if I might obtain 4" performance from a wire version of the antenna. So I applied the two-wire technique described at the beginning of the exercise, only to be disappointed by the results. 2-wire elements, each the same length as those of the 4" model, but spaced to resonate at the same self-resonant frequencies, only brought me half way to the gain goal.

The 2-wire element substitutes required a spacing of 13" between 0.1" wires. Here we must note that my models will not use full precision in the interests of keeping numbers as rounded and simple as possible. So 13" spacing became convenient and close to the mark. However, the rounding of the spacing value was not sufficient to account for the gain value of 7.77 dBi, nearly 0.4 dB short of the mark.

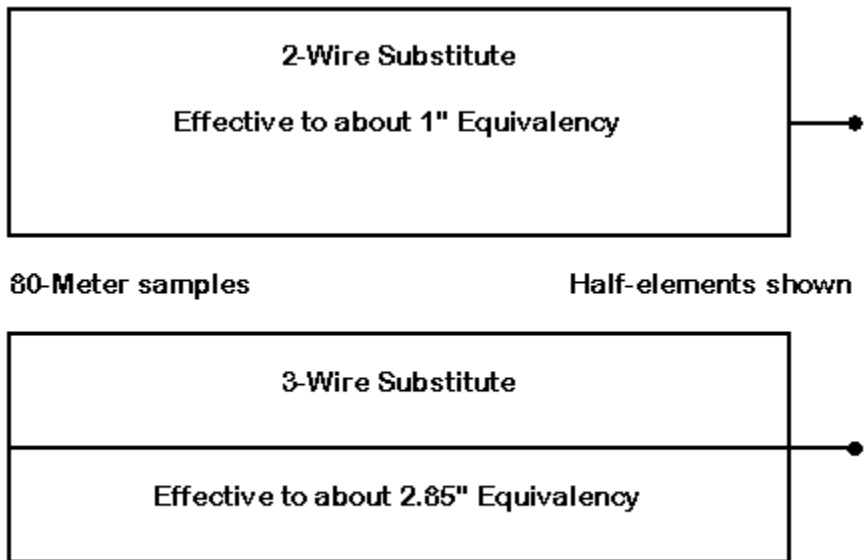

Alternative Substitute Element Structures

Fig. 6

The answer lies in the insufficient coupling provided by the 2-wire model elements. So I added a third wire exactly between the 2, as shown in **Fig. 6**. The half-elements shown are matched by equivalent mirror images to the unseen right of the figure. The third wire does not substantially change the resonant frequency of the resulting element, so I left the outer spacing of 13" and hence ended up with a spacing of 6.5" between wires.

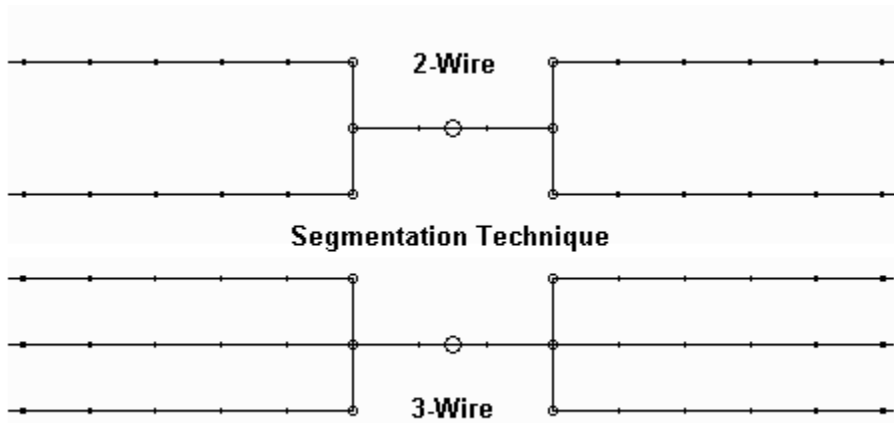

Fig. 7

Before we look at the results of the wire-beam models in detail, we can pause a moment to examine the element models, partially shown in **Fig. 7**. The rules for NEC note that closely spaced wires should have all segment junctions parallel to each other. As well, angular junctions should have segment lengths of approximately equal lengths. Finally, the source segment should be protected from multiple wire junctions, which results in a 3-segment center section for each element. (Although the parasitical elements might have been made continuous, I preserved the center sections in each that resulted from initial resonating tests.) Finally, results will be most accurate for multi-wire elements where the wires are closely spaced and parallel if the source wire is centered so that it meets equal wire lengths in both components of the element. The wires are joined at the outer ends.

Since the segments length of the wire from the center or source wire to the outer wires is 6.5" long, I made this value the segment length for the entire array. The center wire is 19.5" long in 3 segments. The elements beyond the limits of the figure have over 100 segments per wire on each side of center. Hence, the 2-wire model has over 1400 segment, while the 3-wire model tops 2100 segments. Although for some, this would be overkill, it meets all NEC guidelines. Only a little patience is needed while NEC grinds out the results during frequency sweeps.

Part of my interest in the wire models was to determine if each of these models had a single-wire model of roughly corresponding performance. That model would consist of a single fat wire per element, with the diameter chosen to approximate the performance of the corresponding wire model. Of course, the element lengths had to be adjusted relative to those for the 4" model in order to place peak performance at the design frequency.

**1. The 2-Wire Model and a 1" Single Wire Model:** A 1" diameter element model yielded a set of performance curves roughly similar to those of the 2-wire model. We know the physical dimensions of the 2-wire model from the discussion above. The following table presents the physical aspects of the 1" model.

3-Element Yagi: 3.6 MHz: 1" diameter elements		
Element	Element Length (ft)	Spacing from Reflector (ft)
Reflector	137.50	----
Driver	131.50	41.167
Director	123.76	88.767



The design-frequency (3.6 MHz) performance for the two models is in this table.

NEC-4 Modeled Performance: 3-Element Yagis: 3.6 MHz

Model	Gain dBi	F-B Ratio dB	Feedpoint Z R +/- jX Ohms	Efficiency %
1"	7.77	25.7	32.7 - j 0.3	99.42
2x0.1"	7.77	23.7	30.4 + j 2.6	96.73

The comparable performance at the design frequency is readily apparent. Note, however, that the efficiency of the single wire 1" model is significantly higher than that of the 2-wire model, owing to the higher material losses and smaller surface area available from the pair of thinner wires. Indeed, the surface area ratio is about 5:1 in favor of the 1" model. Nevertheless, the increased mutual coupling made possible by the 2 spaced wires is sufficient to overcome the increased material losses and nets the same gain at the design frequency as the more efficient fat-wire model.

The comparison can be extended to the current magnitude and phase found on the parasitic elements with a source current of 1.0 at 0.0 degrees.

NEC-4 Modeled Element Currents: 3-Element Yagis: 3.6 MHz

Model	Reflector I Magnitude	Phase	Director I Magnitude	Phase
1"	0.407	134.9	0.556	-127.8
2x0.1"	0.391	136.7	0.583	-132.1

Note that the parasitic element current values of these two models are closer to each other than either is to the standard 4" model. The models might have more closely corresponded had the elements in

the 2-wire model been spaced more precisely than the 13" used in the model. In fact, the 2-Ohm reactance value indicates not only a slight driver over-length for the spacing, but as well a similar situation for the other elements as well. Hence, the best SWR value and front-to-back peak occurs below the design frequency. In addition, for an equal-gain situation, the required mutual coupling among elements to overcome the higher material losses in the 2-wire model would also dictate slightly different parasitic element current values relative to the single wire model.

## 1" vs. 2x0.1" Element Yagis Free Space Gain

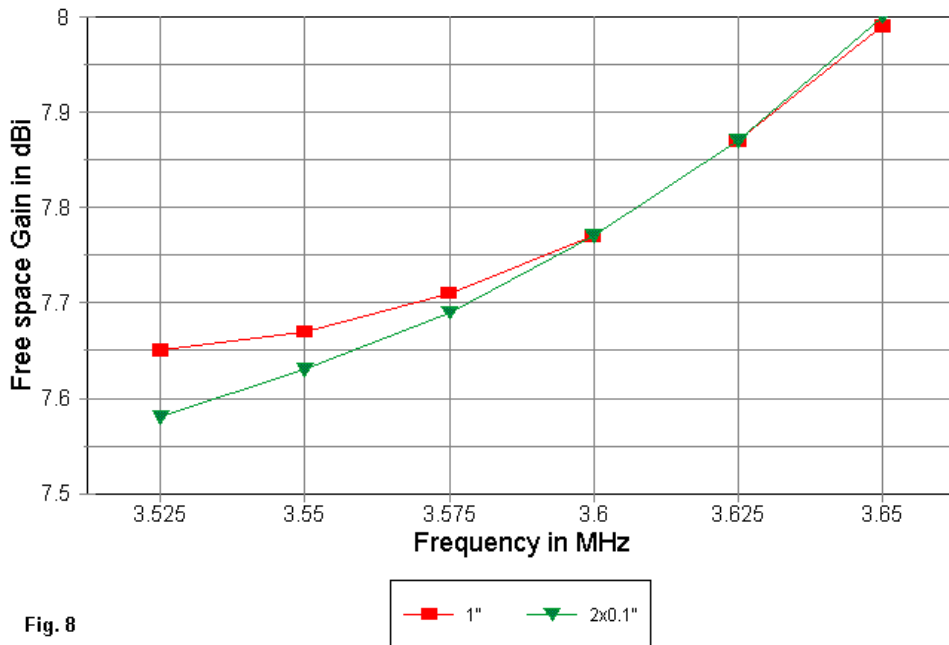

The similarities and differences between the two models become more apparent when we perform frequency sweeps. In this case, due to the remnant inductive reactance of the 2-wire element replacements, I have dropped the lower limit of the sweep to 3.525 MHz. In the case of the gain sweep, shown in **Fig. 8**, the differences show up in different rates of increase in gain across the passband--not widely different, but different nevertheless.

## 1" vs. 2x0.1" Element Yagis Front-to-Back Ratio

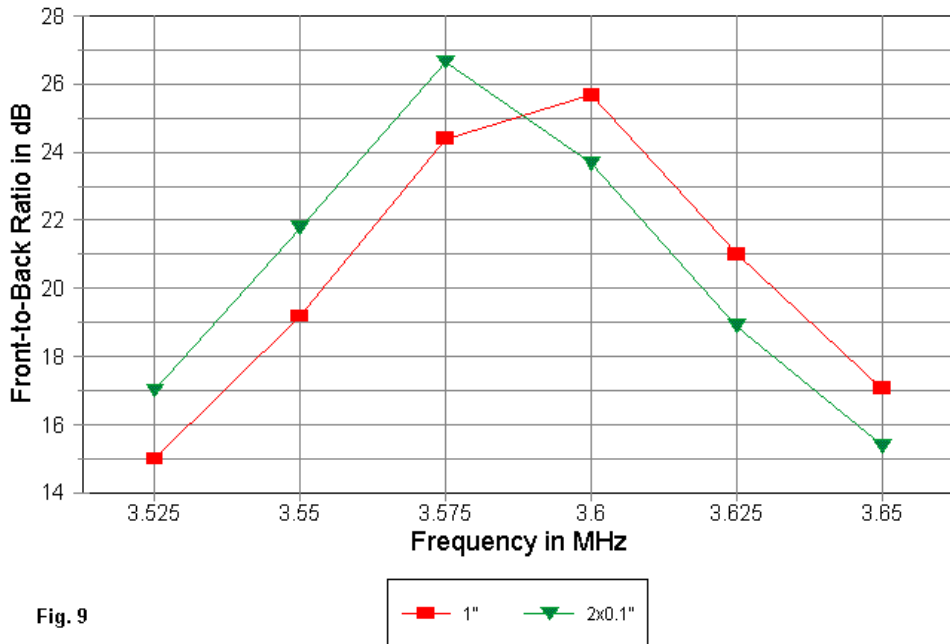
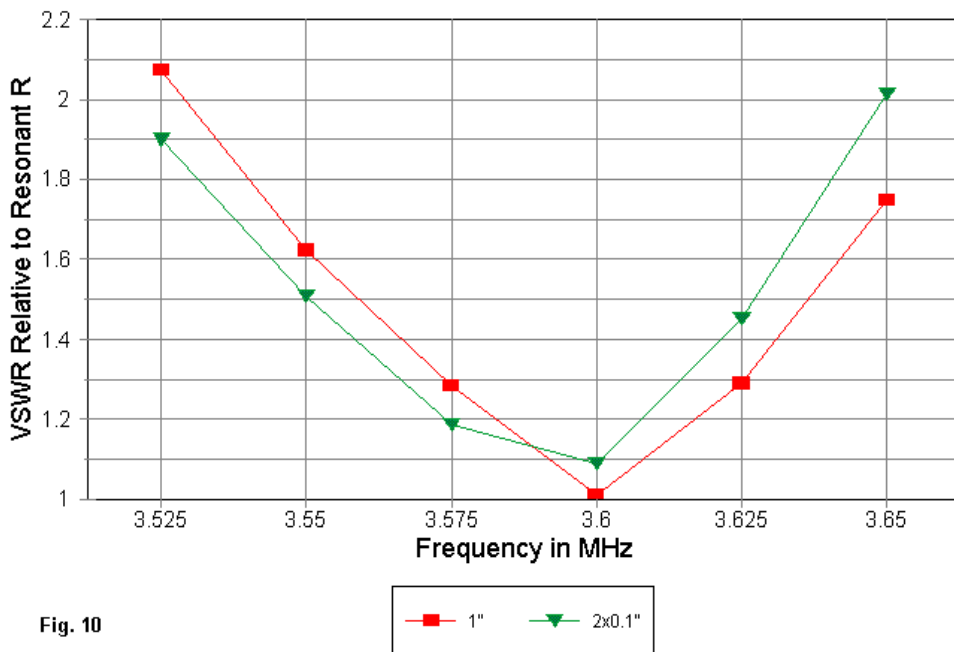

Fig. 9

**Fig. 9** shows the front-to-back ratio sweep for the two models. The 1" model reaches peak front-to-back ratio just below the design frequency, while the 2-wire model shows its peak about 25 kHz below the design frequency. The curve confirms the note above that some fine tuning of the 2-wire spacing (a slight narrowing) is necessary to create a true overlap of curves. However, the ultimate front-to-back peaks of both antennas are quite close, pushing

above 27 dB. Moreover, extending the sweep scale shows that the curves are quite congruent, since the lower end differential is about the same as the upper end differential.

### 1" vs. 2x0.1" Element Yagis VSWR



The SWR curve in **Fig. 10**, tells a similar tale. The passband end differentials are reasonably close so that the offset between the

curves does not lead to any misleading conclusions about the 2:1 operating bandwidths of the 2 models. They are essentially the same.

The end result--despite the small offsets in the curves and number--is the conclusion that for practical purposes, the 2 0.1" diameter wire elements with 13" spacing in the Yagi model provide the same performance potential as a single 1" tubular element set in the same model. The higher mutual coupling of the wire model offsets the higher material losses, resulting in a beam with the same performance over the range of vital performance parameters as that of a single fat element model.

**1. The 3-Wire Model and a 2.85" Single Wire Model:** I would like to be able to say that the 3-wire model overcame all remaining differentials with the 4" model of the 3-element Yagi. However, some differential remained, although it might be considered minor. A 2.85" diameter element model yielded a set of performance curves roughly similar to those of the 3-wire model. Once, more, we know the physical dimensions of the 3-wire model from the discussion above. The following table presents the physical aspects of the 2.85" model.

3-Element Yagi: 3.6 MHz: 2.85" diameter elements		
Element	Element Length (ft)	Spacing from Reflector (ft)
Reflector	136.48	----
Driver	130.30	41.167
Director	122.66	88.767

The design-frequency (3.6 MHz) performance for the two models is in this table.

NEC-4 Modeled Performance: 3-Element Yagis: 3.6 MHz

Model	Gain dBi	F-B Ratio dB	Feedpoint Z R +/- jX Ohms	Efficiency %
2.85"	8.04	27.6	27.4 - j 1.7	99.75
3x0.1"	8.04	21.7	26.0 + j 6.1	97.32

The comparable performance at the design frequency is readily apparent. Note, however, that the efficiency of the single wire 2.85" model is still significantly higher than that of the 3-wire model, owing to the higher material losses and smaller surface area available from the trio of thinner wires. Indeed, the surface area ratio is about 9.5:1 in favor of the 2.85" model. Nevertheless, just as with the 2-wire model, the increased mutual coupling made possible by the 3 spaced wires is sufficient to overcome the increased material losses and net the same gain at the design frequency as the more efficient fat-wire model.

The comparison can be extended to the current magnitude and phase found on the parasitic elements with a source current of 1.0 at 0.0 degrees.

NEC-4 Modeled Element Currents: 3-Element Yagis: 3.6 MHz

Model	Reflector I		Director I	
	Magnitude	Phase	Magnitude	Phase
2.85"	0.410	141.1	0.588	-132.0
3x0.1"	0.387	141.3	0.623	-137.2

Once more, there are differences between the two models with respect to current magnitudes and phases on the parasitic element

centers--but not great ones. The remnant 6-Ohm reactance on the 3-wire driver element is a result of having performed no adjustments in the spacing to compensate for the addition of the center wire. In fact, the reactance value on the driver also indicates not only a slight driver over-length for the spacing, but as well a similar situation for the other elements as well. Hence, the best SWR value and front-to-back peak occurs below the design frequency. As with the 2-wire model, for an equal-gain situation, the required mutual coupling among elements to overcome the higher material losses in the 3-wire model would also dictate slightly different parasitic element current values relative to the single wire model.



## 2.85" vs. 3x0.1" Element Yagis Free Space Gain

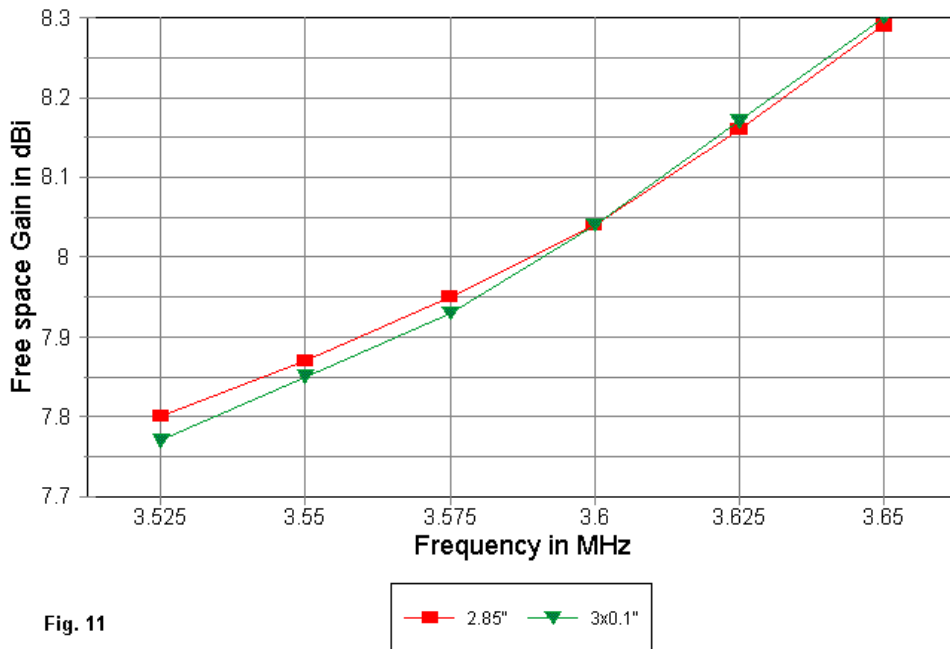

However, when we make allowances for the offset in self-resonant frequencies of the individual elements, the curves for the single 2.85" element model and for the 3-wire model remain remarkable congruent. **Fig. 11** shows the gain curves, which show even smaller differences than those we saw in **Fig. 9** across the same passband for the frequency sweep.

## 2.85" vs. 3x0.1" Element Yagis Front-to-Back Ratio

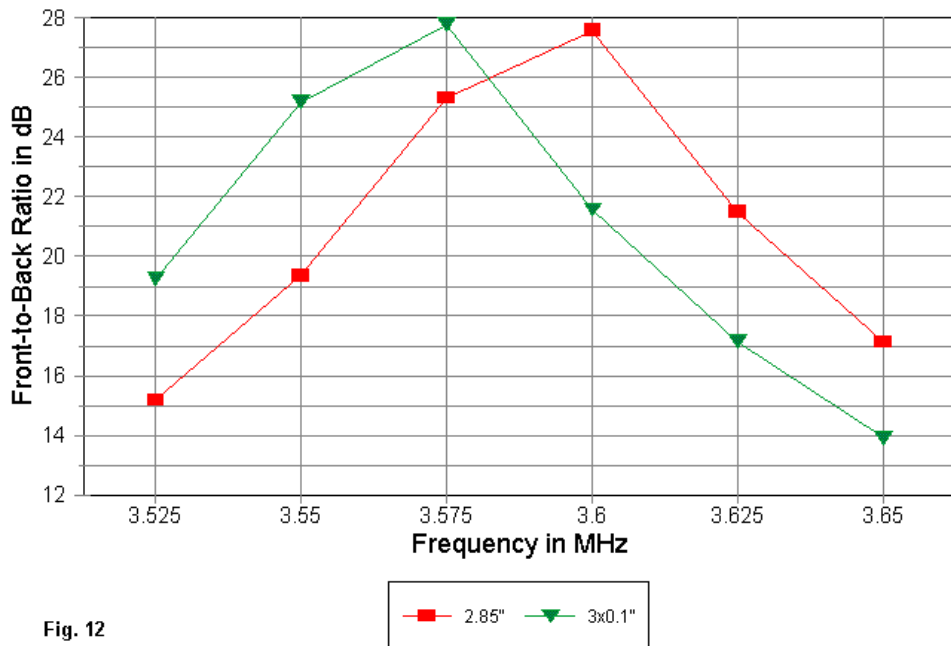

Likewise, the two front-to-back ratio curves in **Fig. 12**, display excellent congruence with a displacement that is almost exactly 25 kHz. Compare not only the offsets at the front-to-back peaks, but as well the lower frequency 19+ dB point and the higher frequency 17+ dB points.

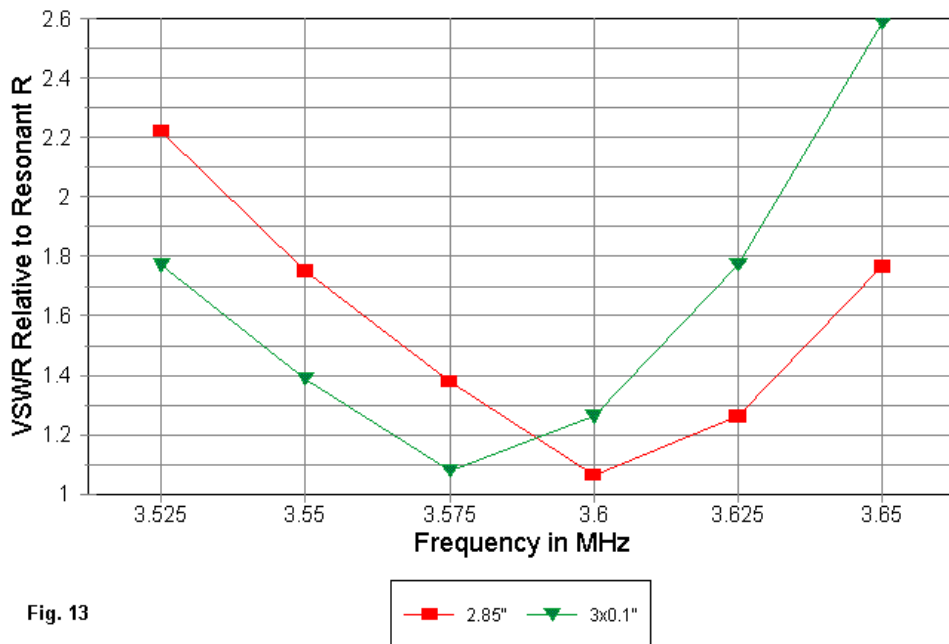
2.85" vs. 3x0.1" Element Yagis  
VSWR

**Fig. 13** portrays a similar offset with respect to the SWR curve for both models. The shapes of the curves are virtually identical, despite the 25 kHz offset between them. In effect, bringing the entire set of curves for the two models into alignment would likely be a matter simply of adjusting the spacing of the wires in the 3-wire elements.

Alternatively, one might also slightly shorten the elements of the 3-wire model slightly. In actual construction practice, this procedure would become the most practical, since it is likely that the wire elements, including spacers, would be fixed in construction phases that precede raising the antenna to operating height.

The 3-wire model ends up slightly short of the goal of achieving the full gain of the initial 4" diameter element model. However, the deficit is only about 0.1 dB. Front-to-back performance can be as good as the initial model, and the feedpoint impedance will be comparable.

In effect, the exercise has established that it is possible to create thin wire models with multiple wires per element that simulate effectively the performance of fat tubular elements in beams and arrays--at least for this 3-element Yagi model. The requisite spacing and possibly the number of wires required will vary with the wire size chosen and the diameter of the element being simulated.

It is not sufficient simply to create elements from multiple wires. The spacing of the wires is of great significant in increasing the mutual coupling between wires that yields the desired level of performance, understanding that some excess coupling may be needed to overcome higher material losses in the wire substitutes. If nothing else, this exercise has suggested some interesting relationships between the roles of material losses and mutual element coupling in beam performance.

Besides the flat plane, other wire configurations are possible, including triangles, squares, and the traditional cage hexagon of wires. However, the extra weight of 6 wires, relative to the 3-wire plane used in the models presented here, may not be needed to effectively simulate fat wires. In the final analysis, two pieces of design work are needed. One is, for any proposed array, a set of models to establish the relative structures of equivalent multi-wire substitutes for a given fat single element. The other, of course, is a mechanical analysis to determine the best compromise among the physical properties of the resultant element. The properties might include ease of construction, durability in the proposed environment, and ease of raising the structure to its operating height.

Of course, the home antenna builder might well decide that using single wire elements is the simplest construction method and that the performance deficits relative to the ideal still fall within an acceptable level. While it is one thing to tangle at a computer with complex models of substitute multi-wire element substitutes, it is quite another to have to wrestle with the real thing, namely, the tangle-prone wire elements that require raising into operating position.

## Chapter 43: The Collinear-Broadside-Endfire Array

For many years, *The ARRL Antenna Book* has shown a combination collinear, broadside, endfire array, for example on pages 8-51 to 8-54 of the 19th Edition. The array looks something like the outline in **Fig. 1**.

The "Lazy-8JK"

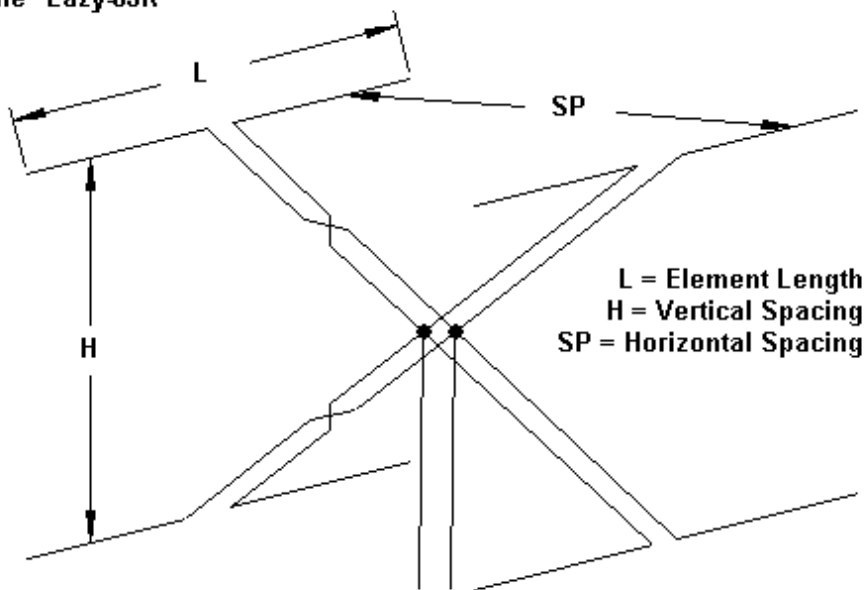

Fig. 1

The dimensions are locked up in 3 key factors:

1.  $L$  = Element Length: Length may vary from  $1/2$  wavelength up to well over 1 wavelength.
2.  $SP$  = Horizontal Element Spacing: Horizontal spacing may range from  $1/4$  wavelength to  $3/8$  wavelength.
3.  $H$  = Vertical Element Spacing: Vertical spacing may range from  $3/8$  wavelength to  $3/4$  wavelength.

The write-up shows a typical pattern with good bi-directional gain. However, a myriad of questions remains for anyone contemplating building such an array. However, we can boil the questions down to just two.

### **What do we get? What do we pay?**

If we look carefully at the sketch, we can see that the array in **Fig. 1** only becomes a collection of collinear elements when the element lengths approach and pass beyond the 1-wavelength mark, at which time, we can consider them to be collinear half-wavelength elements. The vertical dimensions surround those that we associate with the Lazy-H antenna. If we look carefully at the sketch, we can see that the two left-side elements are in phase with each other, since the lines to each left-side element have half-twists. Likewise, the right-side elements are also in phase with each other. The 2 top elements are out of phase with each other, the sign of a W8JK array. Likewise for the bottom 2 elements. Of

course, all of this assumes that all 4 lines from the central junction are equal in both length and characteristic impedance.

Therefore, I have dubbed the array the "Lazy-8JK." This name is very much shorter than calling the assembly a collinear, broadside, endfire array. The latter expression is descriptive, because the top and bottom elements form pairs that are endfire arrangements, while the left and right pairs are broadside arrangements.

Identifying the array as related to both the Lazy-H and the W8JK gives us a means of answering the latter question, at least in part. What we pay is something over twice the complexity of either the 8JK or the Lazy-H. Before we are finished, we shall examine some other costs for the array, but this much is a beginning.

The tougher question is knowing what we get for our effort. However, identifying the array as a combination of Lazy-H and 8JK arrays gives us a foundation from which we can work. Let's transform the question into this one: What are the advantages in performance of the Lazy-8JK over either the Lazy-H alone or the W8JK alone? Now we have something with which to work.

## **A Review of the Lazy-H Broadside Array**

In its basic form, the Lazy-H is a very old but well-proven antenna design with distinct advantages among wire arrays. Originally, it consisted of two 1-wavelength elements vertically spaced  $1/2$ -wavelength apart. However, users later discovered that the antenna



would operate effectively over a wide frequency range using a parallel transmission line and a wide-range antenna tuner.

### The Lazy-H Array

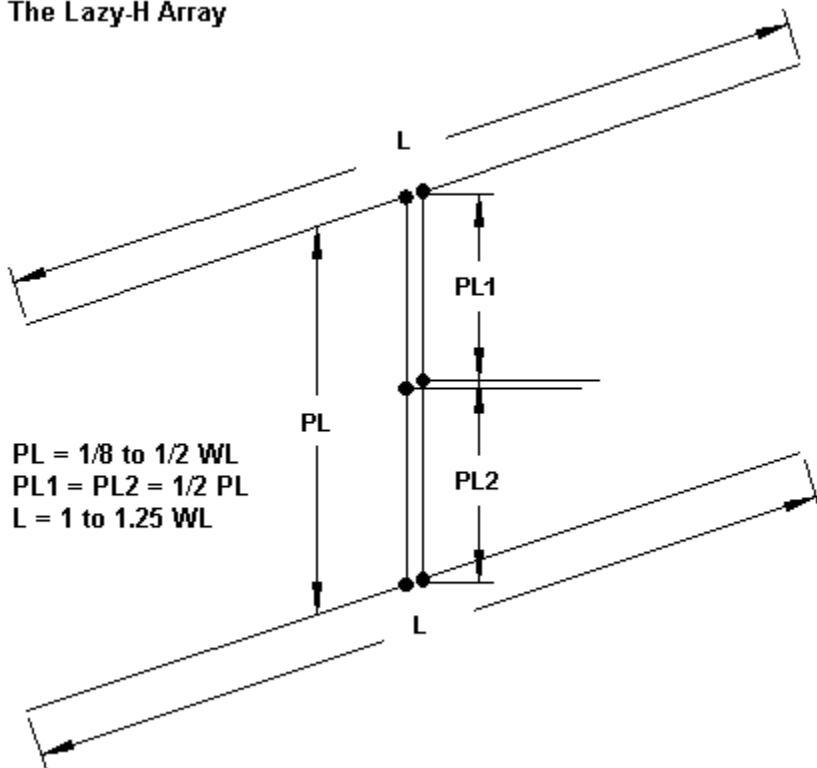
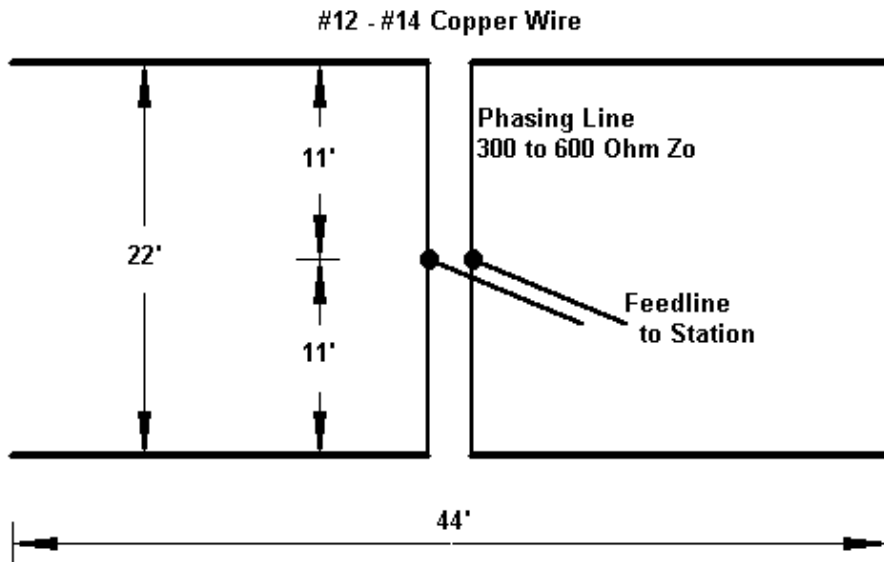

Fig. 2

In **Fig. 2**, we see the essential electrical components of the Lazy-H. The horizontal wires marked L are the elements. PL, the phase-

line, is broken into two equal parts, PL1 and PL2. As the diagram indicates, the two elements are fed in-phase with no twists on either phase line section. The main feedline, attached at the junction of PL1 and PL2, provides equal power to each element. Essentially, then, the Lazy-H consists of two doublets, vertically spaced and fed in-phase, in order to obtain considerable gain over a single doublet of the same length mounted at the approximate array center.

The array produces bi-directional patterns on all bands within the operating range. The elements must be no more than about 1.25 wavelengths to achieve a bi-directional pattern. The antenna will operate at higher frequencies, but the pattern breaks down into multiple lobes as the electrical length of the elements increases at higher frequencies. As well, maximum gain occurs when the elements are about 5/8-wavelength apart. At the highest frequency of bi-directional operation, the antenna has been called the extended or expanded Lazy-H.



Extended/Expanded Lazy-H: Physical Dimensions

Fig. 3

**Fig. 3** shows one common form of the Lazy-H that is useful for operation on amateur bands from 10 meters down to 40 meters. On 10 meters, the 44' wires are about 1.25 wavelengths, dropping to 1 wavelength on 15 meters, and becoming progressively electrically shorter as we reduce frequency. The 22' spacing is 5/8 wavelength on 10, 1/2 wavelength on 15, and electrically closer on lower frequencies. We shall use this model as a foundation for this evaluation of the Lazy-8JK in order to provide a consistent set of dimension throughout. In addition, we shall place the bottom wire of

the Lazy-H at 44', with the top wire at 66'. With these dimensions and heights, we obtain the performance in the following table.

Extended Lazy-H Performance Potential

Freq. MHz	Gain dBi	TO angle degrees	Beamwidth degrees	Feed Z R+/-jX Ohms
28.1	15.3	9	31	40 + j 305
24.95	14.6	10	41	20 + j 100
21.1	12.5	11	52	25 - j 35
18.118	10.9	13	61	50 - j 145
14.1	9.0	17	73	495 - j 145
10.125	8.1	24	85	50 + j 105
7.1	6.3	33	99	10 - j 100

Because the elements grow shorter and the spacing becomes closer with decreasing frequency, the gain drops with frequency. That fact becomes clear from the overlaid azimuth patterns in **Fig. 4**. The 10-meter azimuth pattern shows its extended-double-Zepp family resemblance, while the 15-meter pattern has the classic shape for 1-wavelength elements. Although the full usable operating band-spread for the antenna appears in the table and pattern graphic, we shall focus only on operation in the 5 highest HF bands from 20 meters onward.

Azimuth Patterns  
Expanded Lazy-H  
66' Top Height  
40 - 10 Meters

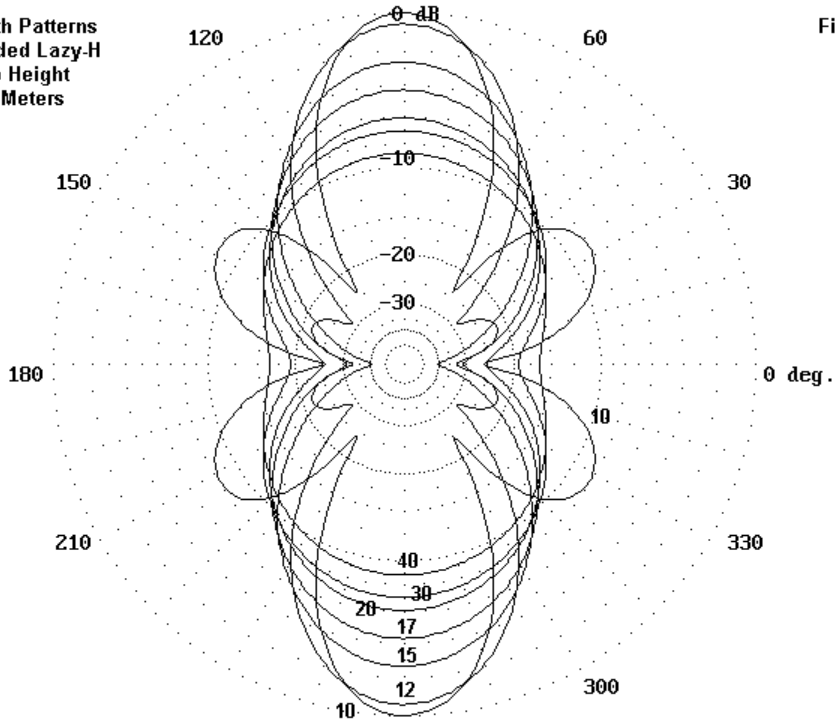

Fig. 4

## A Review of the W8JK Endfire Array

In its basic form, the 8JK is a very old but well-proven antenna design with distinct advantages among wire arrays. The array name derives from its inventor, John D. Kraus, W8JK, who wrote on various forms and facets of the antenna from 1937 to the present. Originally, the 8JK consisted of two  $1/2$ -wavelength elements horizontally spaced from  $1/8$  to  $1/2$  wavelength. However, users

later discovered that the antenna would operate effectively over a wide frequency range using a parallel transmission line and a wide-range antenna tuner.

The W8JK "Flattop" Array

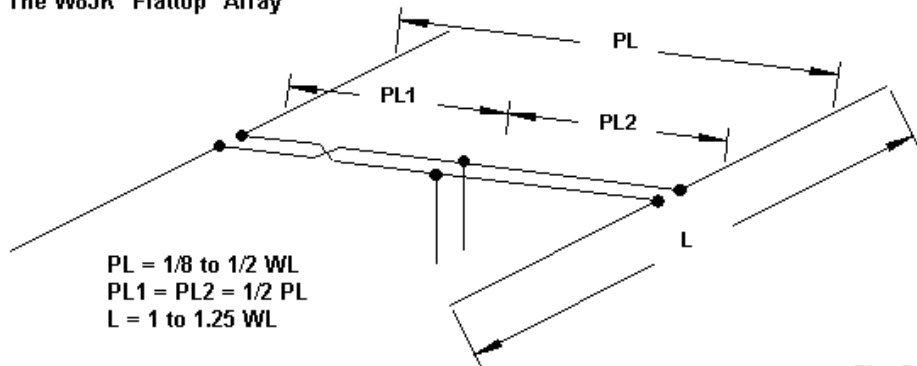

Fig. 5

In **Fig. 5**, we see the essential electrical components of the 8JK. The horizontal wires marked L are the elements. PL, the phase-line, is broken into two equal parts, PL1 and PL2. As the diagram indicates, the two elements are fed out-of-phase with a half-twist on one of the phase line sections. The main feedline, attached at the junction of PL1 and PL2, provides equal power to each element. Essentially, then, the 8JK consists of two doublets, horizontally spaced and fed out-of-phase, in order to obtain considerable gain over a single doublet of the same length mounted at the approximate array center.

The array produces bi-directional patterns on all bands within the operating range. The elements must be no more than about 1.25 wavelengths to achieve a bi-directional pattern. The antenna will operate at higher frequencies, but the pattern breaks down into multiple lobes as the electrical length of the elements increases at higher frequencies. The element spacing is subject to significant variation among builders. The version that we shall explore uses a spacing of  $5/8$  wavelength at the highest operating frequency. This spacing becomes electrically smaller as we reduce frequency, but still is not the spacing for the highest possible gain. In fact, the array tends to increase gain with closer spacing, although the impedance at the feedpoint becomes impractically low. The advantage of the  $5/8$ -wavelength spacing used in this model is that it yields almost constant gain over the entire operating range of the antenna.

The version that we shall explore uses the same wire lengths and spacing as the Lazy-H in **Fig. 3**. The only differences are the fact that the antenna is placed in a horizontal position and there is a half-twist in one (and only one) of the phase lines from the common junction to the elements. Since the Lazy-H has elements at both 44' and 66' above ground, we shall sample performance on 20 through 10 meters at each of these heights.

## Extended Lazy-H Performance Potential

## 44' Above Ground

Freq. MHz	Gain dBi	T0 angle degrees	Beamwidth degrees	Feed Z R+/-jX Ohms
28.1	11.8	11	33	160 + j 505
24.95	11.8	13	41	35 + j 170
21.1	11.1	15	50	25 + j 25
18.118	11.0	17	55	25 - j 75
14.1	10.5	21	61	110 - j 420

## 66' Above Ground

Freq. MHz	Gain dBi	T0 angle degrees	Beamwidth degrees	Feed Z R+/-jX Ohms
28.1	11.7	8	33	165 + j 505
24.95	11.9	9	40	35 + j 170
21.1	11.4	10	40	20 + j 25
18.118	11.3	11	54	25 - j 75
14.1	10.8	14	60	110 - j 410

In these tables--indeed, in all of the tables--the impedance figures are representative values modeled with 450-Ohm transmission line for the phase lines. The actual feedpoint values will tend to vary with changes in either the characteristic impedance or the velocity factor of the line selected. For that reason, I recommend that any prospective builder of any one of these arrays model the installation including the characteristic impedance and velocity factor of the phase lines to be used. From these values, you may calculate the anticipated impedance at the antenna tuner using any one of a number of available transmission line programs, such as TLW or TLD.

At either height, the gain variation is less than 1 dB from 20 through 10 meters. Although the gain is generally lower, on 20 meters the 8JK outperforms the Lazy-H. **Fig. 6** provides the overlaid azimuth



patterns for the W8JK in extended operation to even lower frequencies. Once more, the extended-double-Zepp origins of the 10-meter pattern are apparent.

Azimuth Patterns  
Expanded 8JK  
66' Top Height  
40 - 10 Meters

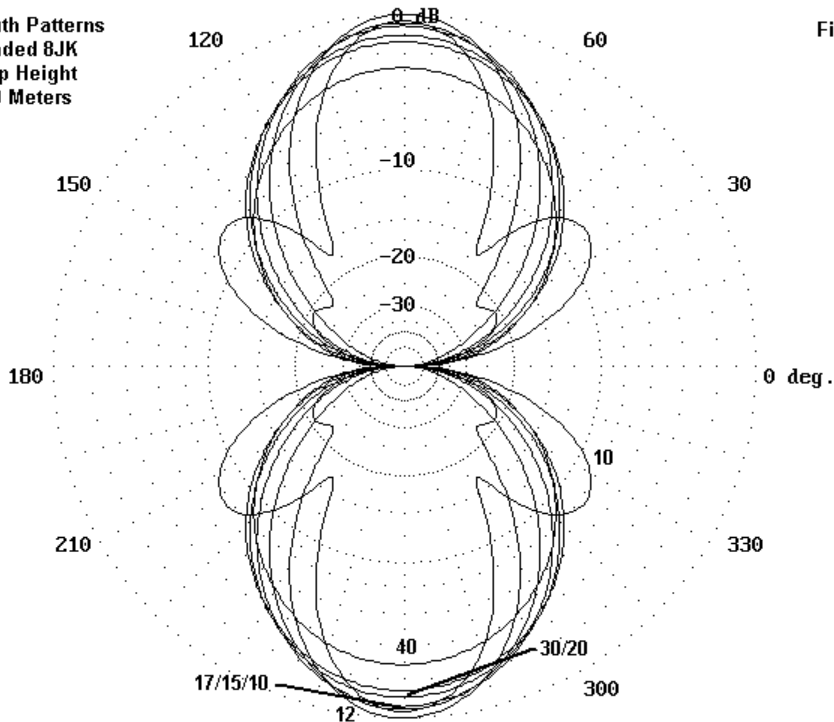
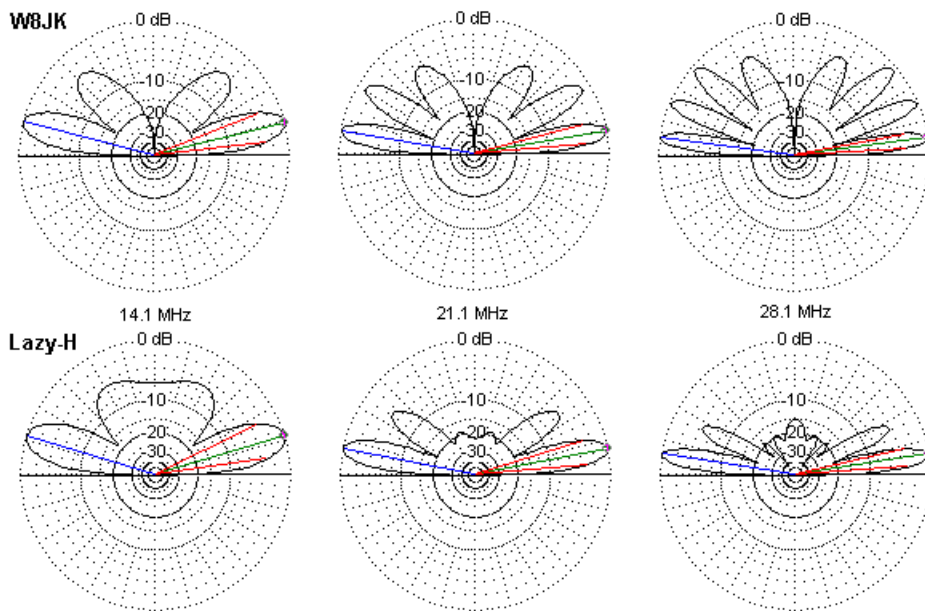

Fig. 6

The gain differences between the 8JK and the Lazy-H are largely due to differences in the amount of energy radiated at high elevation angles. **Fig. 7** shows selected elevation patterns for the

two arrays, with the 8JK patterns taken for a 66' height above ground.



Selected Elevation Patterns for the W8JK and Lazy-H Arrays

Fig. 7

At 21 MHz, where the Lazy-H spacing is almost a perfect half-wavelength, the Lazy-H effectively suppresses high-angle radiation, in contrast to the multiple strong upper-angle lobes of the 8JK. On 10 meters, the Lazy-H does not suppress overhead radiation perfectly due to the wider spacing, but overall suppression of high-

angle radiation is excellent. Still, the 8JK shows even more high-angle lobes. The 8JK begins to exceed the Lazy-H in gain in the lowest lobe on 20 meters. The Lazy-H spacing is down to about  $5/16$  wavelength, a value that is too close for effective suppression of high angle radiation.

### The "Lazy-8JK" Array

Against this background, we may now combine a Lazy-H with an 8JK to arrive at the collinear broadside endfire array, that is, at the Lazy-8JK. The elements of **Fig. 1** describe the most common version of the antenna. For our comparisons, we shall use 44' element lengths, which is about 1.25 wavelengths at 10 meters. The vertical spacing will use the Lazy-H value of 22'.

However, we cannot use the 22' element spacing of the 8JK that we have reviewed. At that spacing, the Lazy-8JK actually shows less gain than a single Lazy-H for 15 through 10 meters. We must compress the horizontal spacing to about 8-11 feet to obtain any usable additional gain from the 4-doublet array. The modeled data are based upon the 11' spacing, although the differences between 8' and 11' are not operationally significant.

In addition, there is an alternative feed system to the one shown in **Fig. 1**, where each of 4 equal-length phase lines combine at a central feedpoint. As shown in **Fig. 8**, we may also construct individual Lazy-H arrays with center feedpoints. We then run equal lines to a center position, giving one and only one of those lines the

necessary half twist to place the left-side doublets out of phase with the right-side doublets.

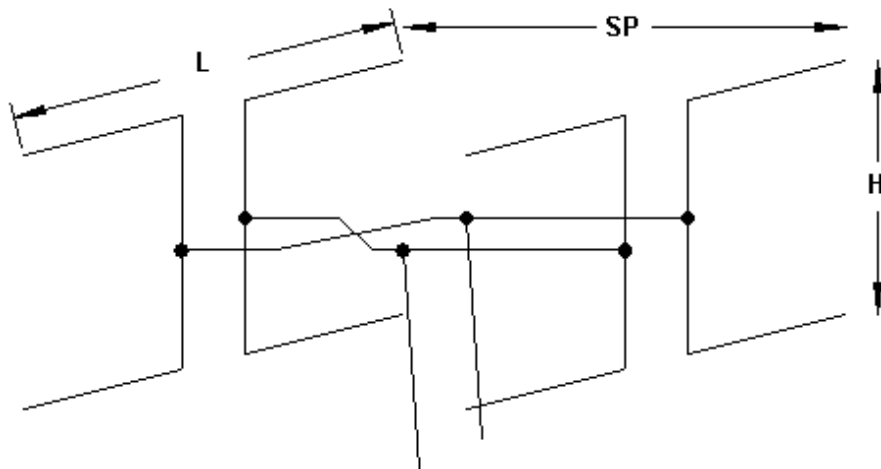

**An Alternative Way of Making a "Lazy-8JK"**

**Fig. 8**

For the 44' elements at 44' and 66' above ground, 11' left-to-right spacing requires two 5.5' phase lines. For the data in the tables, I again used 450-Ohm line for all phase lines.

## Lazy-8JK Performance Potential

## Standard Feed System (Fig. 1)

Freq. MHz	Gain dBi	TO angle degrees	Beamwidth degrees	Feed Z R+/-jX Ohms
28.1	16.5	9	33	50 + j 300
24.95	15.4	10	37	9 + j 90
21.1	13.8	11	45	6 + j 10
18.118	12.8	13	51	7 - j 40
14.1	11.6	16	58	42 - j 260

## Alternative Feed System (Fig. 8)

Freq. MHz	Gain dBi	TO angle degrees	Beamwidth degrees	Feed Z R+/-jX Ohms
28.1	16.5	9	33	1590 + j1870
24.95	15.4	10	37	35 + j 465
21.1	13.8	11	45	10 + j 190
18.118	12.8	13	51	9 - j 85
14.1	11.6	16	58	30 - j 135

**1. Gain Factors:** There is no difference in the gain performance between the two feed systems for the Lazy-8JK. The Lazy-8JK provides a variable gain value according to frequency according to the Lazy-H part of its origins. However, the W8JK portion of its origins shows up in the increments of gain above each of the corresponding simpler arrays. The following table tracks the gain advantage of the Lazy-8JK over the Lazy-H and the W8JK, where the latter uses values for a 66' height above ground.

## Gain Advantage of the Lazy-8JK

All gain values are in dBi at the elevation angle of maximum radiation.

Freq. MHz	Lazy- 8JK	Lazy- H	Added Gain	W8JK	Added Gain
28.1	16.5	15.3	1.2	11.7	4.8
24.95	15.4	14.6	0.8	11.9	3.5
21.1	13.8	12.5	1.3	11.4	2.4
18.12	12.8	10.9	1.9	11.3	1.5
14.1	11.6	9.0	2.6	10.8	0.8

The Lazy-8JK adds only about 1 dB gain to a single Lazy-H in the upper-most bands. However, the 8JK portion of its origins increases the gain on 20 meters by about 2.6 dB. In contrast, the Lazy-8JK shows its highest gain additions over a single 8JK on the top bands, with reduced gain additions with descending frequency. Additionally, the beamwidths for the Lazy-8JK are slightly narrower than for the standard 8JK as a function of the additional gain.

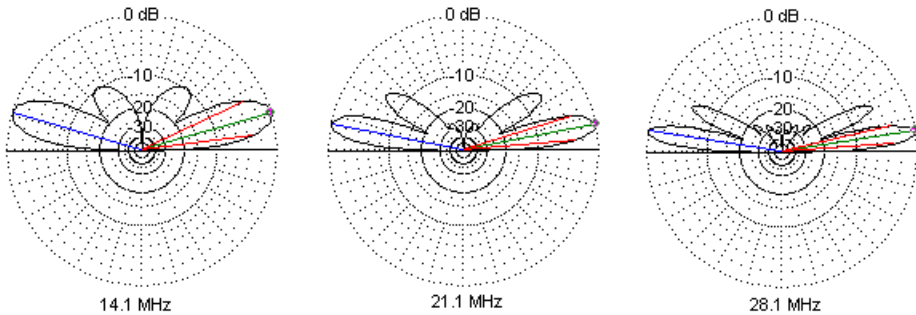

Selected Elevation Patterns for the "Lazy-8JK" Array

Fig. 9

**Fig. 9** shows selected elevation patterns corresponding to those shown for the Lazy-H and the W8JK. The added gain is largely due to a continuing progression of upper lobe suppression. A comparison of 20-meter patterns among all three arrays is especially notable.

Overlaid Azimuth  
Patterns for the  
"Lazy-8JK"  
Array

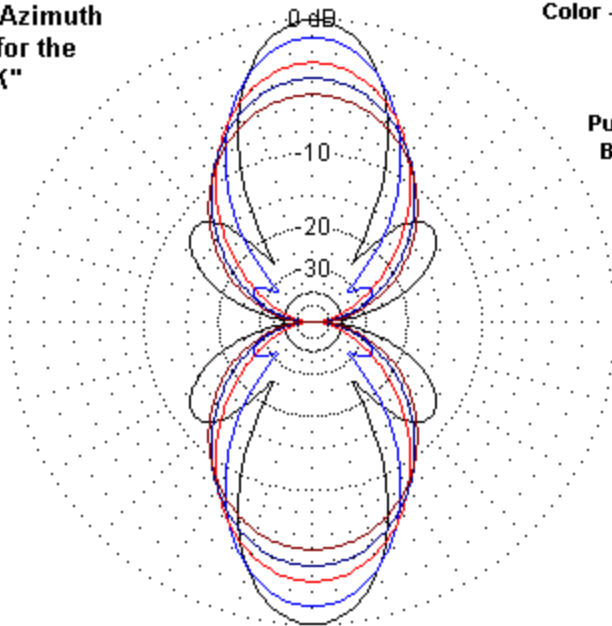

Color - Frequency  
Black = 28.1  
Blue = 24.95  
Red = 21.1  
Purple = 18.12  
Brown = 14.1

**Fig. 10**

To complete the comparisons, **Fig. 10** shows overlaid azimuth patterns for each band, with each pattern taken at the elevation angle of maximum radiation.

From the perspective of gain, then, there are two considerations facing the builder who may weigh the increase in construction complexity against the performance advantage. First, the more complex array shows a better balance of gain than a single Lazy-H, with improvements especially in the 20-meter performance. Second, the Lazy-8JK increases gain on the upper bands over the sampled standard 8JK array. Whether the total improvement is sufficient to warrant the increased construction problems is ultimately a user judgment.

*2. Impedance Considerations:* The differences in the two ways of feeding the Lazy-8JK lie wholly in the area of the feedpoint impedances. The standard X-form of the phase lines (**Fig. 1**) yields more bands on which the feedpoint impedance is under 10 Ohms resistive. Under these conditions, every fraction of an Ohm of loss resistance in the connections transforms a proportionately higher percentage of the power into heat. Hence, great care must be used in the assembly of the system, and equal periodic maintenance care is required.

The alternative configuration for feeding the Lazy-8JK has fewer instances of very low resistive components to the feedpoint impedance. However, 10 meters present a high impedance, with both the resistive and reactive components above 1500 Ohms. As a result of the high variability in feedpoint impedances, the builder very likely will have to pay close attention to the line length between the antenna feedpoint and the tuner terminals to present impedances within the tuner's matching capabilities. This aspect of



the Lazy-8JK is the second half of the answer to the original question of what do we pay.

## Conclusion

The Lazy-8JK (or collinear broadside endfire) array offers different advantages over the standard Lazy-H and the standard 8JK. Since these advantages change with each upper HF band, there is no single answer to the question of whether the larger array is worth the effort of construction.

Nevertheless, by setting up reasonable comparators, these notes will hopefully provide a better sense of both the advantages and disadvantages of going to the more complex arrangement. There are additional dimensions of the final decision. For example, the Lazy-8JK does not lend itself to the relatively simple triangular arrangements of Lazy-H arrays that permit switched directional changes. Nor does the Lazy-8JK allow one to construct an easily rotated version of the array, as is possible with a single 8JK. Yet, the lure of added gain is likely to appeal to at least some aficionados of wire antenna construction. With dimensions of 44' by 22' by 11', it is still a fairly compact upper HF bi-directional array with outstanding performance potential.

## Chapter 44: Curtains for the Extended Lazy-H

### The Basic Expanded/Extended Lazy-H

**A** few years ago, I called attention to a wire array that receives notice only about every fifteen years--despite its excellent performance as a fixed bi-directional array of modest proportions. With two 44' long wires spaced 22' apart, the extended or expanded Lazy-H provides primary service on 20 through 10 meters, with quite adequate service on 30 and even 40 meters. From each element center, we run a parallel feedline--in phase--to a center position, which then becomes the primary feedpoint. We may use any feedline from 300 Ohms to 600 Ohms, although any figures shown in these notes will apply to 450-Ohm line with a 0.95 velocity factor. These notes also presume AWG #14 or #12 copper wire for the elements.

The base of the antenna ideally should be about 44' or more above ground for the lowest elevation angles of maximum radiation (take-off or TO angles). However, if necessity prevent the top wire from reaching 66', then a lower height and higher elevation angles are tolerable.

Chapter 45 next provides a set of representative elevation and azimuth patterns for the antenna. The following table summarizes the performance when set at a 44'-66' height. The gain is the maximum gain at the TO angle. The Beamwidth is the angle between half-power or -3 dB points away from the bearing for

maximum gain. The feedpoint impedance (Feed Z) is at the junction of the two 11' lengths of 450-Ohm parallel line.

.....  
Extended Lazy-H Performance Potential  
.....

Freq. MHz	Gain dBi	T0 angle degrees	Beamwidth degrees	Feed Z R+/-jX Ohms
28.5	15.1	8	31	64 + j 425
24.95	14.6	10	41	17 + j 115
21.1	12.5	11	52	22 - j 18
18.118	10.9	13	61	43 - j 125
14.1	9.0	17	73	403 - j 395
10.125	8.1	24	85	49 + j 105
7.1	6.3	33	99	10 - j 100

.....

The impedances are all quite manageable for a wide-range balanced antenna tuner, with the possible exception of 40 meters and 12 meters. However, the impedance at the tuner will also be a function of the line length in wavelengths from the feedpoint to the tuner, so adjustment of the values to be matched is feasible.

## Planar Reflectors

My reason for returning to the extended/expanded Lazy-H grew out of an inquiry from Bill Burton, T88BA of Pelau. He had assembled the pieces for the antenna. However, he had also seen some commercial arrays that used a curtain-style reflector. Hence, he asked whether such a reflector was feasible for the big Lazy-H.

I have seen a number of schemes for multiple extended double Zepps of about 44' and even for the Lazy-H, all designed to use

parasitic elements or phased elements to convert the bi-directional array into a directional beam. Their complexity could be daunting, often with the result that only the builder knew the correct adjustments for each band. On the other hand, a planar or curtain reflector is a broad-band passive addition that might be serviceable.

In UHF work, a planar reflector generally exceeds the dimensions of the active element or array by perhaps  $3/8$  to  $1/2$  wavelength on all four sides. Such a curtain would be somewhat ungainly for the extended/expanded Lazy-H. So I somewhat arbitrarily selected a set of dimensions that seemed close to feasible for someone with sufficient land to erect the basic antenna at the ideal minimum height. The modeled screen is 50' wide by 30' high. This is only 6' wider than the element lengths and 8' larger vertically. In many ways, it is a minimalist planar reflector.

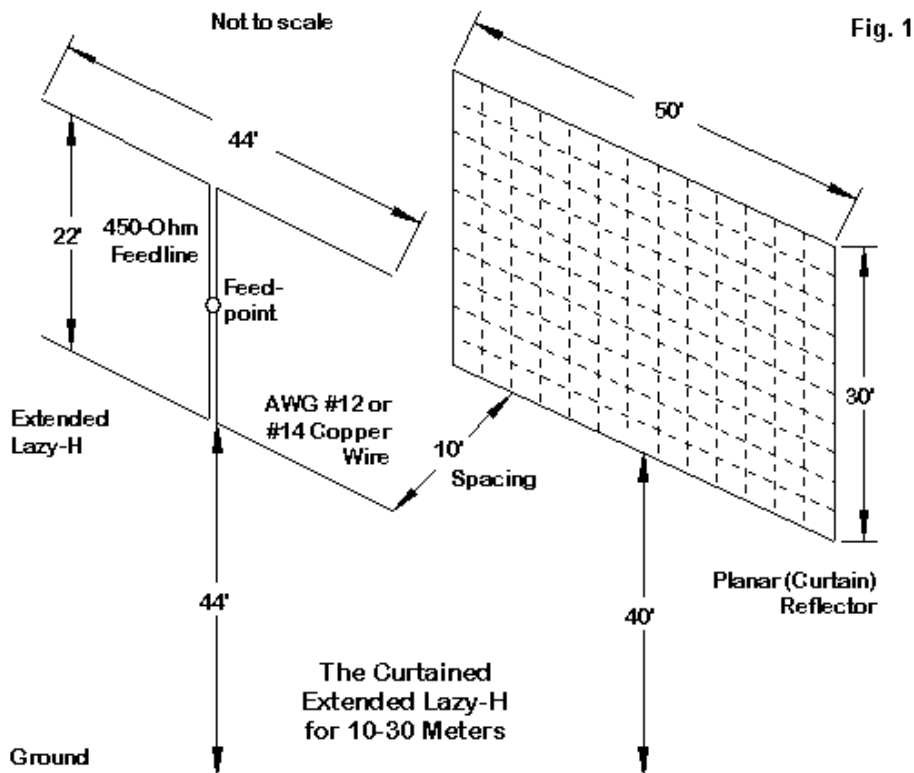

**Fig. 1** shows the parts of the array, although not to scale. The extended/expanded Lazy-H remains unchanged from independent use which results in its bi-directional characteristics. The screen is centered behind the active array. Although the modeled screen uses a grid-square assembly, it is possible to use a sequence of

wires parallel to each other. For this horizontal array, the wires must also be horizontal.

The 10' spacing was my initial trial spacing for the reflector--just a bit shy of 1/4 wavelength at 15 meters. After looking at numerous other spacings, I returned to my intuitive selection, since it provides approximately equal front-to-back ratios at the array limits, namely 10 meters at the high end and 30 meters at the low end.

To see how the curtain or planar reflector changes array performance, examine the following table and compare various values to the ones for the array alone.

..... Curtained Extended Lazy-H Performance Potential .....					
Freq. MHz	Gain dBi	TO angle degrees	Beamwidth degrees	F-B Ratio dB	Feed Z R+/-jX Ohms
28.5	18.4	8	30	13.7	112 + j 430
24.95	17.1	10	40	15.5	29 + j 125
21.1	15.5	11	50	17.1	25 - j 3
18.118	14.4	13	56	16.8	33 - j 100
14.1	13.1	17	63	14.2	175 - j 460
10.125	12.2	23	69	13.8	21 + j 140
7.1	10.0*	30	75	8.3	2 - j 100

The gain increase in the favored direction is between 3 and 4 dB, depending upon the band, with peak increases in the 17 and 20 meter bands. The gain improvement values are consistent with those for any casually designed 2-element driver-reflector Yagi. Peak front-to-back ratio occurs on 15 meters and decreases slowly above and below that band.

The impedance values are interesting. No great change occurs in the reactance values. However, the resistive component shows an interesting pattern. On 15 meters, its value is about the same as the value for the array alone. Above 15 meters, where the spacing is greater than  $1/4$  wavelength, the resistive component of the impedance is higher than for the array alone. Below 15 meters, the resistive component is less than for the array alone, while the spacing is less than  $1/4$  wavelength.

**Fig. 2** through **Fig. 7** provide azimuth and elevation patterns for the array on each band. They require no individual comment. However, the trends in the rear lobe formations should be reasonably clear. In all cases, the patterns are well-behaved, with no spurious lobes--other than the emergent secondary lobes inherent to the array when the active element length approaches 1.25 wavelengths.

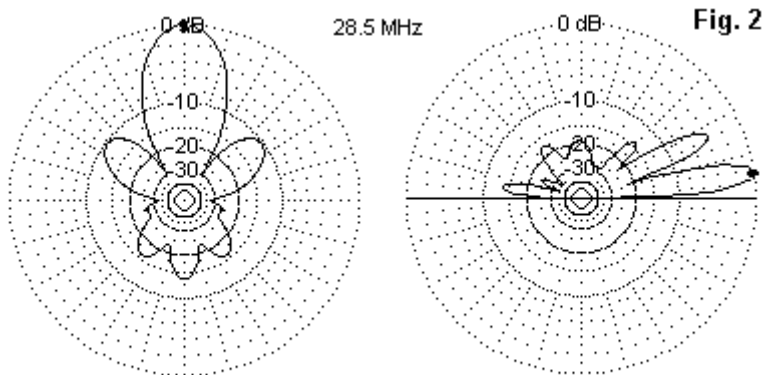

**Curtailed Extended Lazy-H: 10-Meter Patterns**

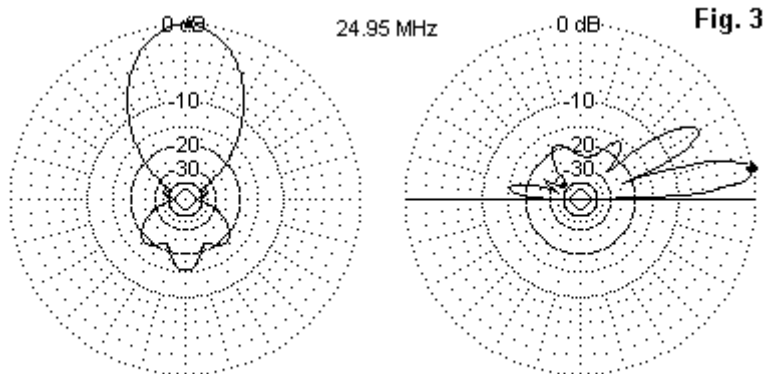

**Curtained Extended Lazy-H: 12-Meter Patterns**

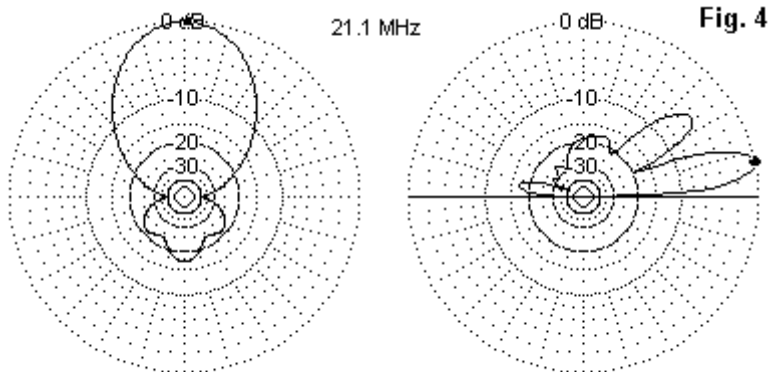

**Curtained Extended Lazy-H: 15-Meter Patterns**



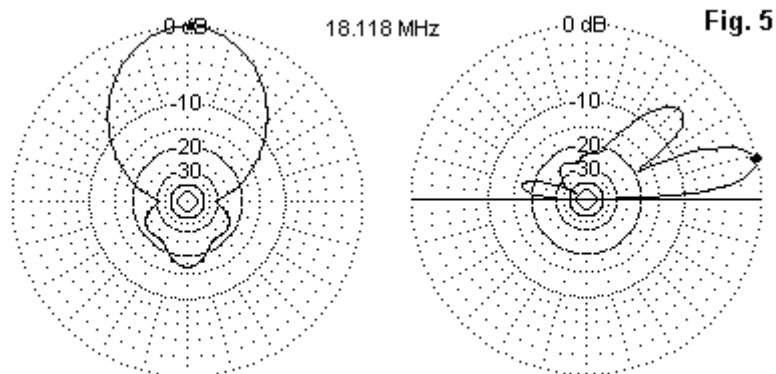

**Curtained Extended Lazy-H: 17-Meter Patterns**

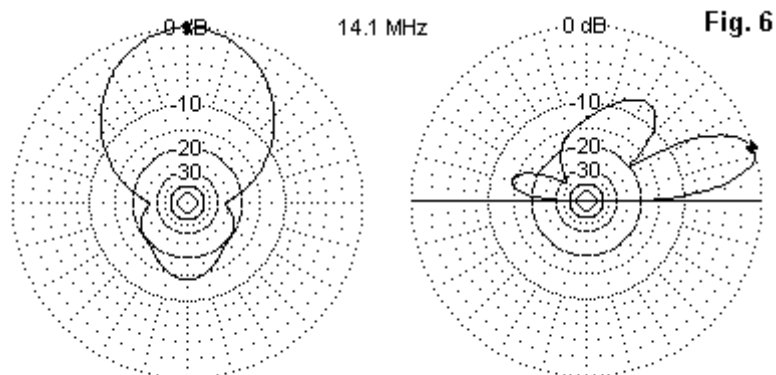

**Curtained Extended Lazy-H: 20-Meter Patterns**

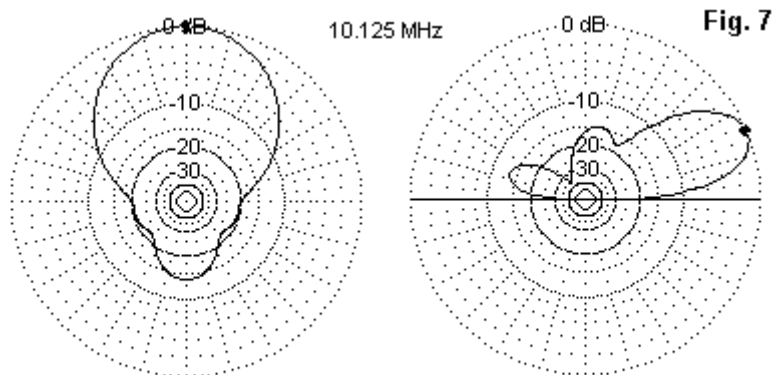

**Curtained Extended Lazy-H: 30-Meter Patterns**

Before leaving our patterns, we must take special note of 40 meters. The gain value for that band is starred. That star indicates that the pattern shows maximum gain in the reverse direction relative to all of the other bands. See **Fig. 8** for azimuth and elevation details.

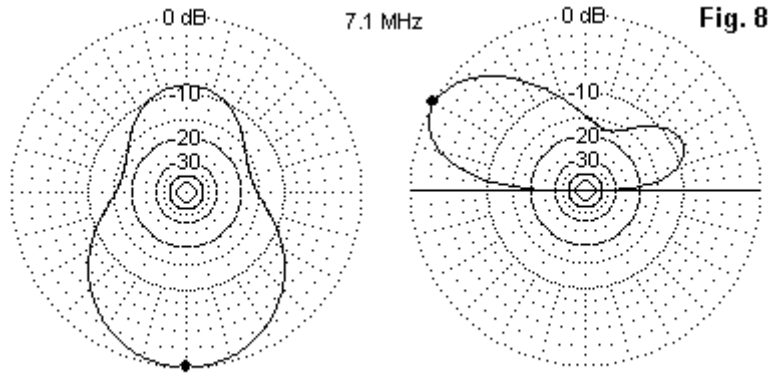

**Curtained Extended Lazy-H: 40-Meter Patterns**

The reason for pattern reversal is simple. The horizontal dimension for the reflector (50') is  $1/2$  wavelength or more for all bands from 30 to 10 meters. However, on 40 meters, the reflector horizontal dimension is only about  $3/8$  wavelength. Hence, despite its vertical dimension, the screen acts like a director at less than  $0.1$  wavelength spacing. The very low resistive component of the feedpoint impedance reflects this condition. It is unlikely that one would be able to take advantage of the reverse pattern, given the potential difficulty in achieving a low-loss match.

### Physical Realities

The proof-of-principle exercise suggests that a minimalist planar reflector or curtain behind an expanded/extended Lazy-H will yield a competent directional beam with a noticeable improvement in gain and quite usable front-to-back characteristics. However, the

requirements for the reflector are sufficiently challenging to make this array an antenna with a somewhat small niche.

Planar reflectors require both vertical and horizontal dimension for highest effectiveness. Too narrow a vertical dimension will degrade the array characteristics as much as too short a horizontal dimension. Since the reflector is untuned, it must be at least  $1/2$  wavelength at the lowest frequency used, with additional length up to about 1 wavelength wherever feasible. Vertically, we improve performance with height greater than those used here, although the vertical dimension will reach its limits of helpfulness more quickly than the horizontal dimension.

Assuming that we can erect vertical supports of the needed height, I recommend some form of halyard assembly to raise and lower the reflector screen. Even an extremely open "chicken-wire" screen reflector will show considerable aggregate wind resistance in violent storms. However, if one desired beaming in both broadside directions, then a pair of screens--with only one raised at a time--will yield a reversible beam. If the user has only one primary target region, lowering a single screen will return the array to its inherent bi-directional pattern, and that may suffice for other operations.

For raising and lowering, we need an open-weave metal "fabric" that will resist snagging when it is crumpled on the ground. However, one might wind the screen around a ground-level cylinder instead of lowering it into a heap directly on the ground. One might even use a combination of horizontal wires and vertical ropes to create a more flexible screen for this purpose. The final product is

suited to the skills of one who has experience with square-rigged sails, with the sail and spar arrangement inverted from those we find at sea. Of course, we shall invert another matter as well: we shall seek to slip the wind rather than catching it.

The curtained Lazy-H is a fixed position wire array of considerable mechanical size and requires equal mechanical ingenuity to implement. However, it holds promise of providing multi-band gain and front-to-back ratio so that the operator can use the upper HF band on which propagation is nearest to optimal for a desired path. The beamwidth on the upper bands is narrow enough to require careful sitting. Although the values in the charts emphasize the amateur bands, the general arrangement may be suitable for short-wave listening in the intervening spectrum--and possibly even for an economical short-wave broadcast installation.

The curtained Lazy-H is certainly not an antenna for everyone. But it may be an antenna for someone.

## Chapter 45: The Expanded Lazy-H

**V**ery effective antennas do not have to be exceptionally large or expensive. The latest designs and construction methods have their advantages--and also their costs. They tend to obscure some older designs of high merit as we forget to remember them.

Rotatable antennas are very effective, but for those unwilling or unable to put a tower, rotator, and sizable aluminum structure in the air, fixed position wire arrays can provide excellent gain. Most designs are bi-directional, but the side rejection is often sufficient to eliminate most QRM. If we have the trees or the poles to support the ends, and if we take the trouble to align the antenna in the most favorable directions for our intended operation, a wire array can work wonders. For example, a great circle drawn through my QTH in Tennessee with one end in VK-ZL land will have its other end in Europe. A bi-directional array might be just the ticket for much of my operating.

Many broadside arrays are flat-tops--that is, they require at least two wires with considerable horizontal space between them. For most purposes, I would need 4 supports. However, a design that has been around since wire became popular is the Lazy-H, a vertical stack of two wires fed in phase. The standard Lazy-H consisted of two 1 wl wires spaced 1/2 wl apart and elevated so that the lower wire was 1/2 wl above ground.

John Schultz, W2EEY, wrote in the November, 1968, CQ of the "Expanded Lazy-H Antenna." Bill Orr, W6SAI, recalled this antenna in one of his many columns during the 1980s. Another 15 years has gone by, so let's recall this effective array one more time. The key to expanding the Lazy-H is to increase both the horizontal and vertical dimensions by just a little bit.

If we increase the wire lengths from  $1 \text{ wl}$  to  $1.25 \text{ wl}$ , we have stacked extended double Zepps in our Lazy-H. The effect is to give us a bit more gain per wire and a significant amount more from the pair. Then, if we increase the spacing from  $1/2 \text{ wl}$  to  $5/8 \text{ wl}$ , we achieve approximately the maximum stacked gain possible with two simple wires.

Now, let's build one of these expanded Lazy-Hs for 10 meters.

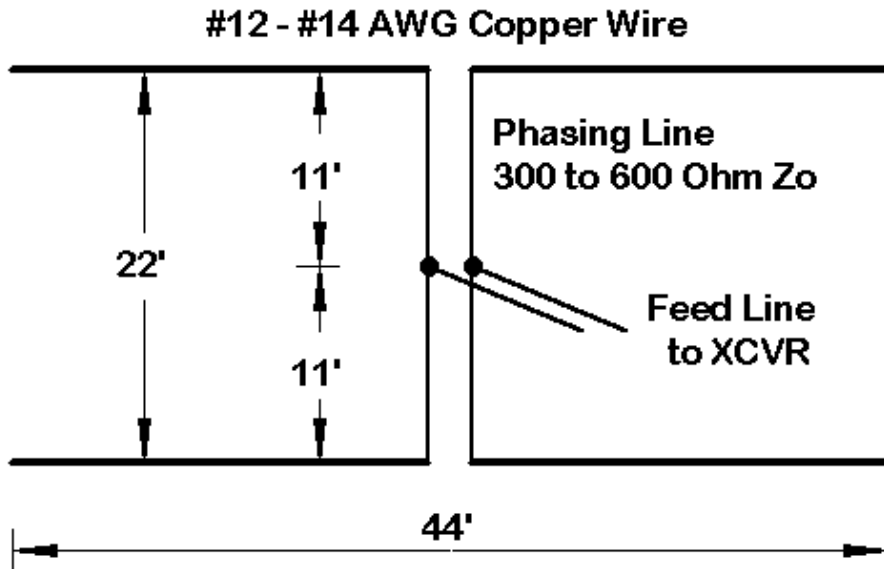

**Fig. 1**      **W2EEY "Expanded Lazy-H Antenna"**

**Fig. 1** shows the antenna outline. For 10 meters, a length of 44' per wire is satisfactory and not critical: 40' to 50' will work, but the pattern on 10 meter begins to split up as we lengthen the antenna too far beyond 1.25 WL. Vertical spacing between the two wires need not be too fussy, but the recommended 22' gives us not only 5/8 wl at 10 meters but a usable spacing at other frequencies.

The recommended minimum of 1/2 wl at 10 meters is a bit low for optimal performance. I would recommend that a lower-wire height



of about 44' be used, which places the top wire at 66' up. Lower heights will reduce the gain and elevate the TO angle from the figures I shall present as we think about this simple array.

The mechanical beauty of the Lazy-H design is that it requires only two supports--although fairly tall ones. The electrical beauty of the antenna is that it provides excellent bi-directional performance from 10 meters through at least 17 meters, with good performance down to 30 meters. It can also be pressed into service on 40 meters without much difficulty.

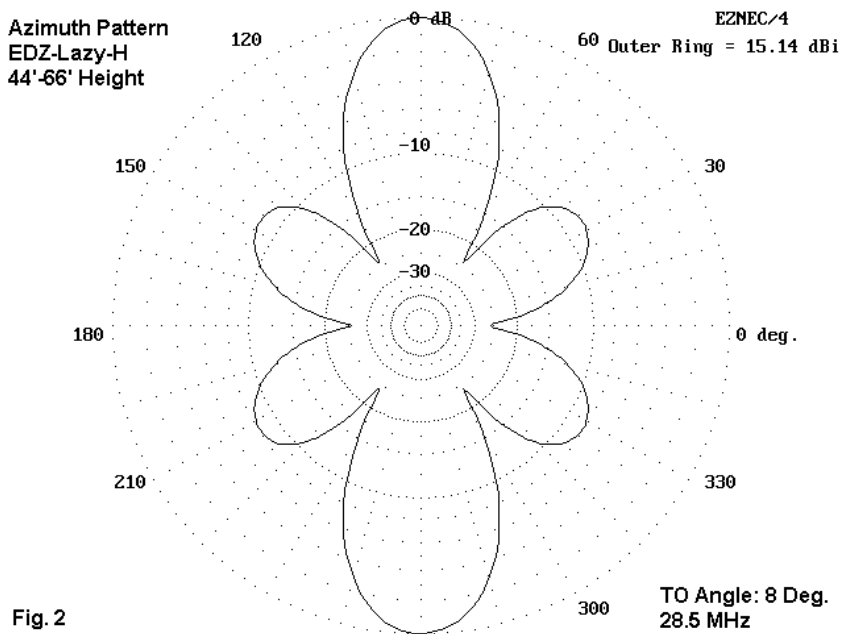

**Fig. 2** shows the azimuth pattern of the antenna on 10 meters at an elevation angle of 8 degrees. The phase-fed array still retains the EDZ "ears." These ears are the beginnings of the multi-lobe pattern that emerges as the antenna wire length grows toward the 1.5  $\lambda$  mark.

On all bands below 10 meters, the length of the antenna is under the EDZ mark, so the pattern is bi-directional with single lobes each way. In fact, at 15 meters, the antenna becomes a standard Lazy-H: two 1  $\lambda$  wires spaced 1/2  $\lambda$  apart vertically.

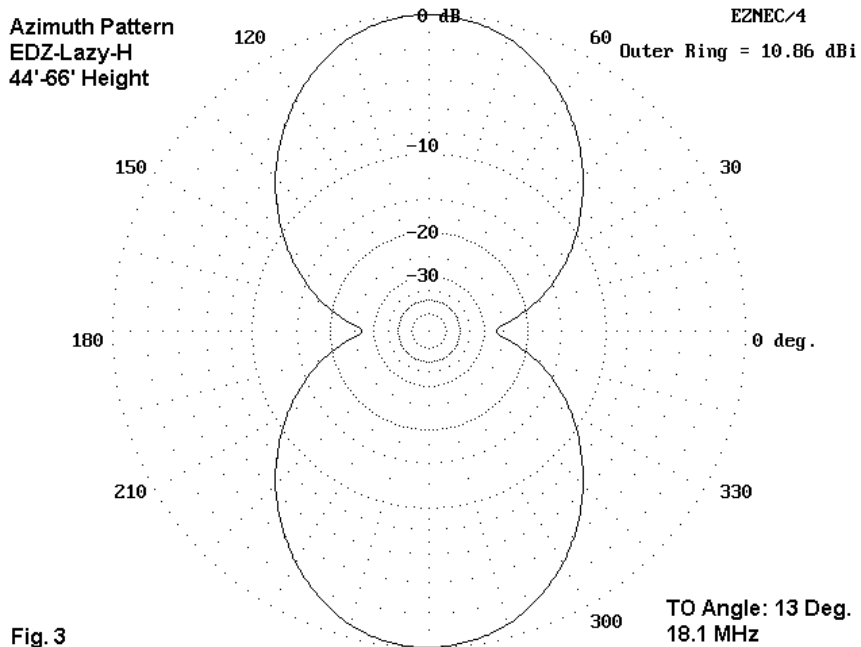
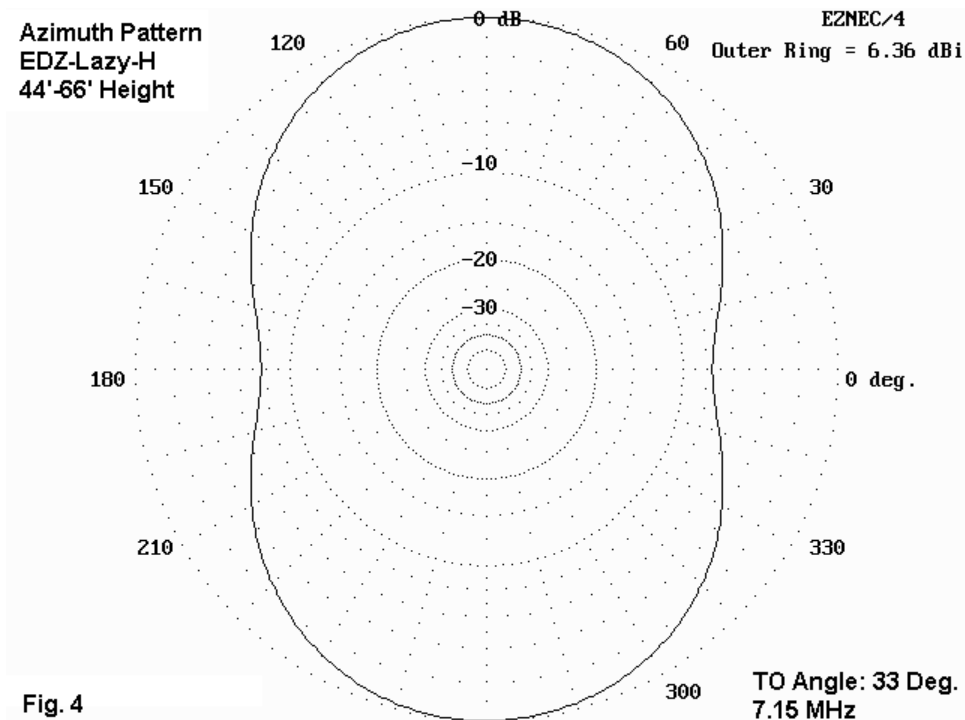

Fig. 3

In **Fig. 3**, we see the 17-meter pattern at its elevation angle of maximum radiation of 13 degrees. As the tables below will show, the lobes become wider as we reduce frequency and narrower as we increase frequency.

For a more systematic view of anticipated performance on all of the possible bands on which we might use this one Lazy-H, here is a table of modeled performance over average ground, with the lower wire 44' up. The table lists the usual gain and TO angle data, but also adds numbers for the vertical and horizontal beamwidths between the -3 dB (half-power) points. This data is useful in determining the azimuth coverage of the antenna in each direction and in estimating the elevation angles to catch the skip for varying circumstances.

Freq MHz	Max. Gain dBi	TO angle degrees	Vert. BW degrees	Hor. BW degrees
28.5	15.1	8	9	31
24.9	14.6	10	11	41
21.2	12.5	11	12	52
18.1	10.9	13	14	61
14.15	9.0	17	18	73
10.1	8.1	24	27	85
7.15	6.4	33	44	99



By the time the antenna's operating frequency is lowered to 40 meters, the pattern becomes a broad oval with a fairly high TO angle, as shown in **Fig. 4**. However, sufficient radiation occurs at lower angles to make it usable for general purpose communications on that band.

How good is the antenna's performance? I could use any number of comparators here, but the simplest would be a single 44' wire

placed 66' up in height, the same height as the top wire of the array. The usefulness of this comparison is that it helps reveal something of the array's characteristics.

Freq MHz	Max. Gain dBi	TO angle degrees	Feedpoint Z R +/- jX Ohms
28.5	10.5	7	150 - j 695
24.9	10.4	8	620 - j1700
21.2	9.0	10	4200 + j 850
18.1	8.6	12	835 + j1560
14.15	7.7	15	190 + j 490
10.1	7.6	20*	56 - j 105
7.15	7.0*	29*	24 - j 600*

The starred gain entry for 40 meters indicates that the single wire at this frequency shows more gain than the array (by about 0.6 dB). In the TO angle column, the starred entries indicate that the single wire shows a significantly lower angle than shown for the array. Both phenomena are related. The array elevation angle of maximum radiation is a composite from radiation from both wires, with the lower wire radiation raising the angle of the final composite pattern. The difference is slight until the very lowest bands on which we might press this antenna into service. On 40 meters, the lower wire is just over 1/4 wl above ground, so that it raises the overall pattern angle of the array by a goodly amount and provides slightly less gain than the single wire that is about 1/2 wl up. As well, The high ratio of reactance to resistance in the feedpoint impedance suggests that there may be difficulty in obtaining a good low-loss match.

From 20 meters on up, the Expanded Lazy-H shows good gain over a single wire. The benefits increase the higher one goes in

frequency, up to the break-up of the pattern when the wires are longer than 1.25 wl. It is certainly possible to scale the antenna for maximum benefits at a lower frequency, but that lower frequency of maximum gain will become the highest frequency at which one can use the array and still have a bi-directional pattern with a single main lobe off each side of the wires.

The single 44' wire also shows a wide variation in feedpoint impedance according to the length of the wire. The 10-meter value is typical for an EDZ. The 15-meter value is also typical, but of a 1 wl center-fed wire. Parallel feeders and a highly competent antenna tuner would be needed for this antenna. However, careful analysis of the impedance excursions along the chosen feedline can minimize the chances that the tuner antenna terminals will see either a resistance or a reactance value outside its range of adjustment.

So far, I have given no figures for the feedpoint impedance of the Expanded Lazy-H. The two elements in Fig. 1 are fed in phase by the simple expedient of using equal lengths (11') of line to a center point to which we attach the parallel feeders going to the antenna tuner. There are two controllable variables that will affect the feedpoint impedance at the junction with the main line to the shack. One is the length of the lines, which we have set at 11' each. The other is the characteristic impedance and velocity factor of the phasing lines. I shall not here explore other phasing line lengths, but instead shall show some anticipated feedpoint impedances for each band using three different phasing lines. One will be a 450-Ohm, 0.95 VF line, typical of windowed vinyl-covered lines. Another

will be 300-Ohm, 0.8 VF line, typical of good quality TV line. The third will be 600-Ohm, 1.0 VF line, which might be bought or built from wire and spacers.

Freq MHz	Feedpoint Impedance (R +/- jX Ohms)		
	450-Ohm 0.95 VF	300-Ohm 0.8 VF	600-Ohm 1.0 VF
28.5	65 + j 425	115 + j 570	105 + j 610
24.9	17 + j 115*	11 + j 140*	30 + j 140
21.2	22 - j 15*	10 + j 38*	40 - j 50
18.1	45 - j 125	16 - j 26*	90 - j 230
14.15	385 - j 395	75 - j 150	1050 - j 350
10.1	50 + j 105	40 + j 65	50 + j 155
7.15	10 - j 95*	6 - j 80*	13 - j 90*

Starred entries represent very low resistive components to the feedpoint impedance which might present larger excursions along whatever line is chosen as the main feedline to the shack. Note that the starred entries are fewest with the 600-Ohm phasing line. Once more, it is worth noting that these numbers are derived for general guidance from models. Variations will emerge from the actual construction of the antenna and from conditions and clutter at the antenna site.

One question that almost always emerges with respect to comparing the single wire and the array gain figures for 10 meters is this: how can the array deliver over 4.5 dB gain over the single wire? The answer is straightforward if we compare elevation patterns for the two antennas. **Fig. 5** tells the tale.

## Elevation Patterns

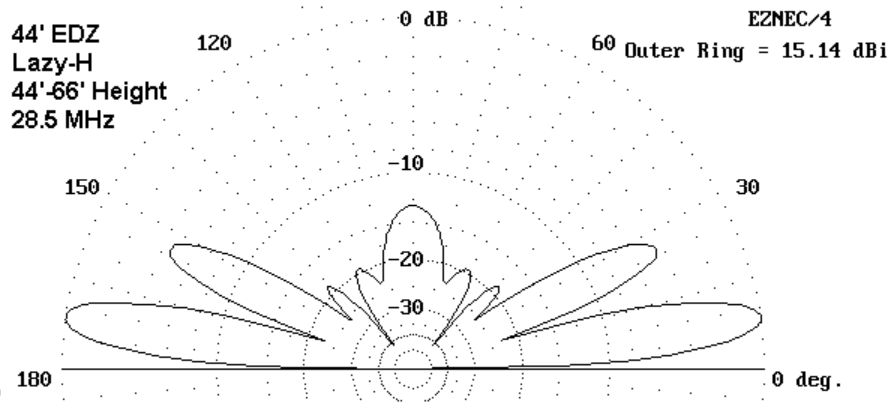
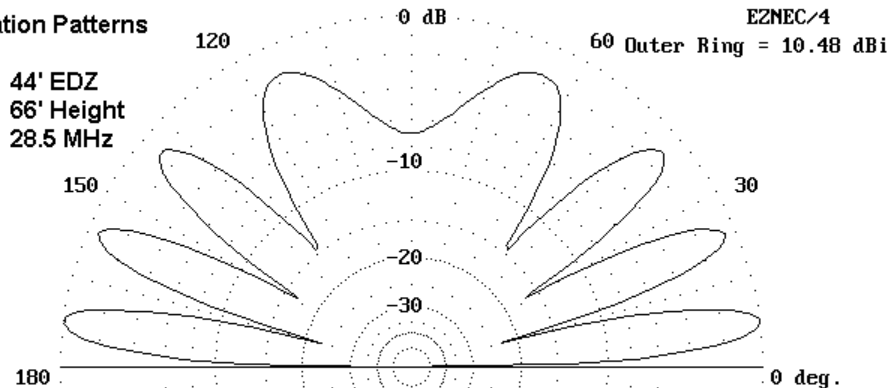
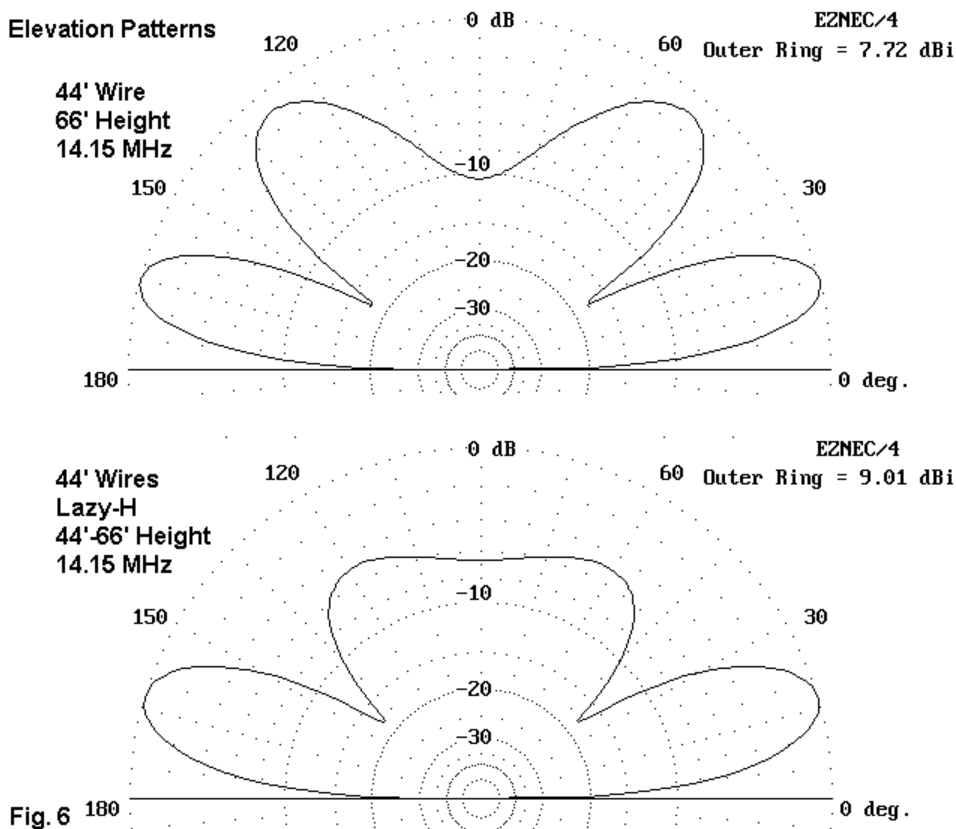

Fig. 5

Like any single-wire antenna, the EDZ at 66' on 10 meters shows an array of nearly equal-strength vertical lobes: 4 to be exact. In contrast, the upper lobes of the Expanded Lazy-H are suppressed leaving a single dominant lobe and a secondary lobe well over 4 dB weaker. All other lobes are down by 12 dB or more. The array



tends to waste far less power at very high angles of radiation compared to the single wire. This comparative pattern, with variations, tends to hold true down through 20 meters.



On 20, the effect is less pronounced but still easily measured, as shown in **Fig. 6**. The area enclosed by the upper lobes of the single wire at the top of the figure is distinctly greater by a considerable margin than the area enclosed by the upper lobe (barely discernable as a double lobe) of the array. The difference in area (assuming that the azimuth patterns are comparable, as they happen to be in this case) is a rough measure of the added power appearing in the lower lobes. In this case, that additional power shows up not only in the maximum gain, but as well in the vertical beamwidth. The phased feeding of vertically stacked horizontal wires has benefits hard to match in a typical flat-top wire array.

Alongside the benefits come some limitations. The Lazy-H requires a pair of tall supports and is suited to the antenna farm with more tall trees than money. It is possible to lay out more than one of these inexpensive antennas in order to cover additional regions along the horizon. It is likely that no special treatment will be needed to detune unused arrays to prevent them from altering the pattern of the array in use. Either leaving the shack end of the unused feedline open or shorting it will introduce to the wire feedpoints sufficient reactance to detune the wires. However, this is a facet of multiple array installation that the builder should keep in mind. Sometimes Murphy dictates that nothing will work to prevent interaction short of greater physical separation of the arrays.

The Expanded Lazy-H is an outstanding bi-directional array for 10 meters in the design given here. Its performance holds up well down through 20 meters, and we can press it into service on lower bands. It takes up very little room horizontally in the yard, although

a couple of optimally spaced tall trees certainly can aid the installation process. The wires for the elements and the phasing lines, as well as the feedline to the shack and the UV-resistant support ropes, are certainly inexpensive compared to the cost of a tower, rotator, coax, and commercial aluminum antenna. It is a design worth recollecting every 15 years or so just to make sure that we do not forget it.

## Chapter 46: Explaining the Modern Dipole Curtain Array

Long-wire antennas served primarily the needs of point-to-point HF communications in the first half of the 20th century. Although some rhombics remained in service within the short-wave broadcast (SWBC) industry, other antenna designs generally took over. SWBC tends to require a broader beamwidth than a rhombic provides. Although the rhombic had the frequency range necessary for frequency shifts in accord with changing HF skip conditions, other antennas could serve as well--or almost as well. Once aimed, the rhombic had a line of targets; SW broadcasters preferred a large region. Even if the target did not encompass the entire region, slewing the antenna's beam pattern could reduce costs by avoiding the need for second and third large high-gain arrays or complex turning mechanisms.

### Antique and Modern Billboard Antennas

The solution to the needs of many SW broadcasters arrived with improvements to a very old antenna, once called the billboard. (See Kraus, *Antennas*, 2nd Ed., p. 547, for a representation of a billboard antenna.) The operational principle is simple. Any bi-directional antenna, such as a dipole, becomes a directional antenna when placed in front of a planar reflector. Planar reflectors find many contemporary uses in the VHF and UHF region today. Hence, we often overlook their continuing service for SW broadcasting. However, their current use depended upon a number of advances, standardizations, and combinatory techniques to give them the relative predominance that they now enjoy.

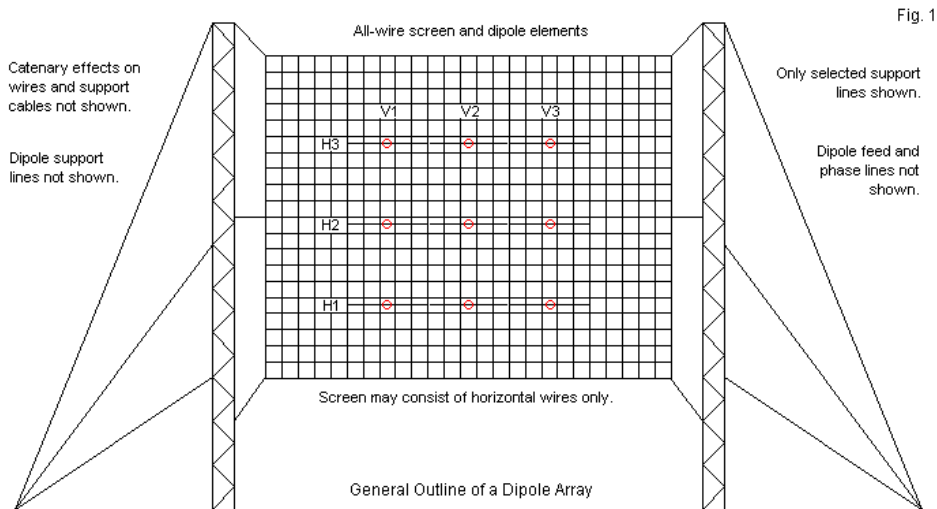

**Fig. 1** sketches (with many missing details) an antenna about which I have received many inquiries. Vacationers encounter them in unexpected places from coast to coast (and well inland) in the U.S. The sketch is not to scale. The towers are much too fat for the array between them. The figure also lists other missing details that would obscure the main function of the antenna. For example, we would normally find many more guy wires for the towers and many more support and spacing wires and jigs for the key elements that form the antenna's radiation pattern.

In return for omitting some details, we can clearly see both the dipole elements in a 3-by-3 array and the reflective screen behind them. In many cases, the screen will consist only of horizontal

wires, similar to the rod-based planar reflectors in my notes on that subject in past articles. Since the horizontal lines are very long, periodic vertical spacers are necessary to maintain the reflector shape.

The 3-by-3 array of dipoles also represents an evolution from some of the original billboard antennas that used center-fed full-wavelength elements. Note also that the dipoles are closely spaced. The overall reduction in billboard size per driver unit formed one of many reasons why the modern dipole array is a primary short-wave broadcast antenna today. Even the original versions effected a major real estate saving over designs such as the rhombic. Of course, many of the original rhombics used timber supports. As steel tower structures became more common and less expensive, they not only replaced existing supports, but also made taller antennas more feasible. Hence, the billboard antenna traded vertical space for longitudinal space, cutting both purchase and maintenance costs. (Never volunteer to mow the lawn beneath a truly long rhombic.)

The dipole array rarely uses its original "billboard" name, although many folks call it a dipole curtain antenna. "Curtain" refers to the planar reflector behind the driven elements. They could move a bit in the wind. Early designs were not fully appreciated for several reasons. First, the high steel structures and copper wire were subject to corrosion. Breakage required more repair effort than splicing a rhombic leg. However, one of the electrical limitations of the billboard was its narrow operating bandwidth.

In the first half of the last (20th) century, almost all antenna designers strove to produce as much gain as might be feasible from a given design. This bad habit still infects much of the antenna design for amateur radio. We accept excessive problems in feedpoint matching by designing long-boom Yagis with the minimum number of elements necessary for a certain gain level. Even if we overcome that problem, we continue to accept relatively poor sidelobe suppression because we refuse to add a few more elements to the design. We continue to make excuses for antenna designs that are difficult to replicate due to their narrow operating bandwidth. (There are good reasons in certain circumstances for using a narrow beamwidth, but in general, it is usually a condition with which we are stuck for lack of design imagination.)

Early billboard antennas suffered from narrow operating bandwidth for several reasons. First, the driving elements used a spacing from the reflector screen that yielded maximum gain. Second, they looked for element-to-reflector spacings that left the feedpoint impedance unchanged relative to the same driver with no reflector. Third, they used driven element lengths and spacings that yielded maximum gain. For example, a collinear pair of 1/2-wavelength elements (or a center-fed full-wavelength element) yields a little more gain than a simple 1/2-wavelength dipole. (The high impedance of this type of element, of course, permitted the use of wide-spaced transmission line segment for feeding and phasing, a condition very suitable for high-power SWBC operations.) Although we knew that we might obtain even more gain with a vertical spacing of 5/8 wavelength, 1/2-wavelength became the standard for the ease of feeding a vertical collection of elements in phase.

Rarely did we have the room to arrange the elements horizontally at optimal spacing. Initially, we used some very close spacing to reflector screens, sometimes as low as  $1/8$  wavelength. When we discovered that a wider spacing would yield more gain and weaker rear lobes, we opted to use that spacing despite the fact it still limited the operating bandwidth.

Modern dipole curtain arrays operate on other principles. Some common ones, found in Chapter 26 of Johnson's *Radio Engineering Handbook*, 3rd Ed., reappear in **Fig. 2**. We may note in passing that an engineer for TCI, a leading producer of dipole curtain arrays, wrote the 3rd edition version of the chapter on HF antennas. If the volume is not conveniently available, you may find some of the same data at the [TCI website](#). Look at model 611 for a general description of their dipole curtain arrays.



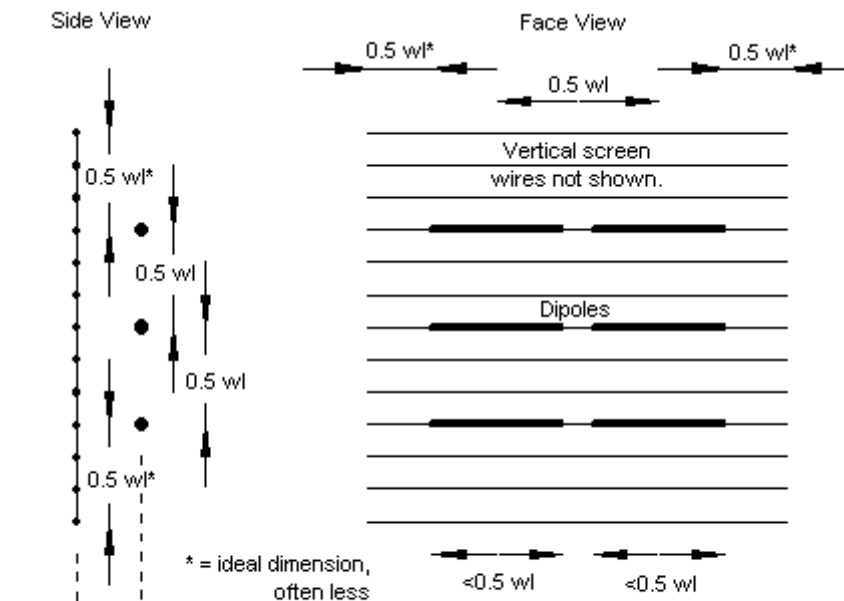

Fig. 2

Generalized Dimensions for a Typical 3V-2H Dipole Array

The side view of the antenna shows the vertical heights generally used: 1/2 wavelength between dipoles of the array. Studies of planar reflectors strongly suggest that this antenna type achieves maximum gain for a given driver set when the reflector screen exceeds the driver assembly by 1/2 wavelength or so in every direction. Realities, including catenary effects on an all-wire assembly, usually dictate less reflector extension except perhaps at corners.

The face view shows the equally desirable horizontal reflector extension, although every extra foot of reflector screen adds to costs for perhaps marginal performance improvements. The most notable feature of the face view is the arrangement of the driver dipoles. Since a driven dipole is normally slightly less than a physical half wavelength, we may place the dipoles on 1/2-wavelength centers across the reflector. Because designers still wish to use wide-spaced transmission lines for feeding and phasing, the driven elements are usually some form (in some cases, an exotic form) of a folded dipole.

The final element to note from the sketch is the recommended spacing of the elements from the reflector screen: 0.3 wavelength. A simple dipole tended to show maximum gain and weakest rearward lobes with considerably closer spacing, but by accepting a lower gain per driver, the designer achieves a wider operating bandwidth. Before we close these notes, we shall look at the combination of ingredients that go into extending the operating bandwidth of a dipole array.

We (but not necessarily the designers) might express the overall goal in this manner: since wire elements are relatively light, we can obtain more performance by packing more elements within the available space rather than from seeking out the maximum performance from the minimum number of elements. Most of the array weight (but not necessarily stress in adverse weather) lies in the reflector lines or screen. The element spacings in the sketch--and any extension of the sketch--provide the most performance for a given space (side-to-side and vertical) occupied by the array.

Performance here includes not only gain, but beamwidth, rear lobes, and feedline SWR for some specified reference impedance.

## How the Dipole Array Achieves Its Performance

Let's back up a step and see how the modern dipole array achieves its performance. That step requires that we first examine dipoles on their own, that is, with no reflector screen. We shall survey in tabular form the maximum gain of various combinations of dipoles. Of course, the listed gain will be for a bi-directional array. We shall designate each combination by a code of the order  $mV-nH$ , indicating the number of dipoles stacked vertically ( $m$ ) and horizontally ( $n$ ). Each vertical dipole will be  $1/2$  wavelength from its neighbor, and horizontal dipole lines will be on  $1/2$ -wavelength centers. The data include both the gain and the horizontal beamwidth. More correctly, the beamwidth is in the E-plane, since all values for this exercise are for free space. All dipoles consist of folded dipole made from AWG #10 copper wire. The test frequency is 10 MHz.

### Free-Space Performance of Various Dipole Arrays

Array Size	1V-1H	1V-2H	1V-3H
Maximum Gain (dBi)	2.13	3.79	5.30
Beamwidth (degrees)	78.4	48.2	33.2
Array Size	2V-1H	2V-2H	2V-3H
Maximum Gain (dBi)	5.94	8.01	9.69
Beamwidth (degrees)	78.5	48.2	32.8
Array Size	3V-1H	3V-2H	3V-3H
Maximum Gain (dBi)	7.80	9.72	11.27
Beamwidth (degrees)	78.4	48.0	32.8

The 2V-2H configuration offers the greatest step-gain increase over versions with one less vertical or one less horizontal dipole. The gain steps are not smooth for two reasons. First, gain increases diminish as we add steps in a linear count. As well, the dipoles interact, so that gain is not strictly additive. Slightly different spacing values or even horizontal end-to-end distances may alter some of the numbers. Nevertheless, the overall progression of dipole maximum gain values is a fair representation of the potentials of dipole arrays on  $1/2$ -wavelength centers.

One interesting fact about the progressions is that the E-plane beamwidth does not significantly change as we add dipoles vertically. Narrower beamwidths result from adding dipoles horizontally. Since the beamwidths of each level of horizontal stacking are constant, regardless of the size of the vertical stack, we can represent the array patterns with samples taken with a vertical stack of 2. **Fig. 3** shows the pattern shapes for 1, 2, and 3 horizontal dipole stacks. The patterns for 1 and 2 horizontal dipoles are perfectly normal and familiar. The pattern for 3 dipoles resembles the pattern for a center-fed  $1.25$ -wavelength extended double Zepp doublet.

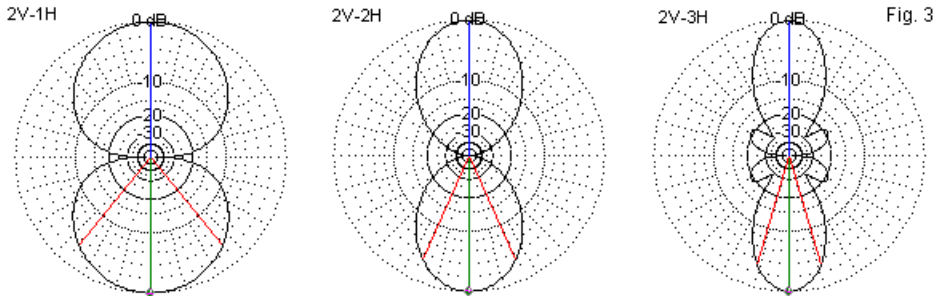

Selected Dipole Array E-Plane Patterns

Over ground, the E-plane patterns would not change shape significantly. The elevation pattern depends upon the height of the array above ground. Typically, an installation will adjust the dominant elevation angle for a design frequency by adjusting the bottom height for the array selected, which might be still larger than the samples used here. Although literature tends to use the average height of the array as a calculating point, the arrays equivalent height tends to be about  $2/3$  the distance between the height of the lower dipole and the height of the highest dipole. This figure does not vary much from the array's average height, but it does show up in vertically phased arrays (like the lazy-H) where the lowest height may be a large fraction of a wavelength above ground. Indeed, the lazy-H is a billboard antenna without the billboard, although some amateurs have added screen reflectors for increased directivity.

Adding a screen to the folded-dipole arrays that we have just surveyed creates a directive beam antenna. As shown in **Fig. 2**, the

recommended spacing between the dipole arrays and the screen reflector is about 0.3 wavelength. The value is not optimal for maximum possible gain. In fact, designing a dipole array for maximum possible gain would require customizing each dipole element and the array spacing for every possible combination. The 0.3-wavelength spacing provides good gain and pattern shaping without regard to customizing the dipoles to account for their interaction. As a test, I created a screen for each folded dipole in the first sequence. Each screen consisted of a wire grid of standard modeling proportions (0.1-wavelength squares with a wire diameter that is the square side divided by  $\pi$ ). Each screen exceeds the dipole array dimensions both vertically and horizontally by 0.5 wavelength. The test frequency remains 10 MHz. To the data in the first table, I have added the 180-degree front-to-back ratio as a measure of rearward performance.

Free-Space Performance of Various Dipole Arrays with Screen Reflectors

Array Size	1V-1H	1V-2H	1V-3H
Maximum Gain (dBi)	7.45	8.68	10.11
Front-to-Back Ratio (dB)	19.24	21.18	21.78
Beamwidth (degrees)	69.6	48.8	33.0
Array Size	2V-1H	2V-2H	2V-3H
Maximum Gain (dBi)	9.77	11.21	12.85
Front-to-Back Ratio (dB)	21.44	28.73	28.90
Beamwidth (degrees)	72.4	48.8	32.8
Array Size	3V-1H	3V-2H	3V-3H
Maximum Gain (dBi)	11.72	13.22	14.87
Front-to-Back Ratio (dB)	21.58	29.33	29.34
Beamwidth (degrees)	72.0	48.6	32.8

Because the rear lobe structure changes, the gallery of E-plane patterns in **Fig. 4** includes plots for all of the entries in the table.

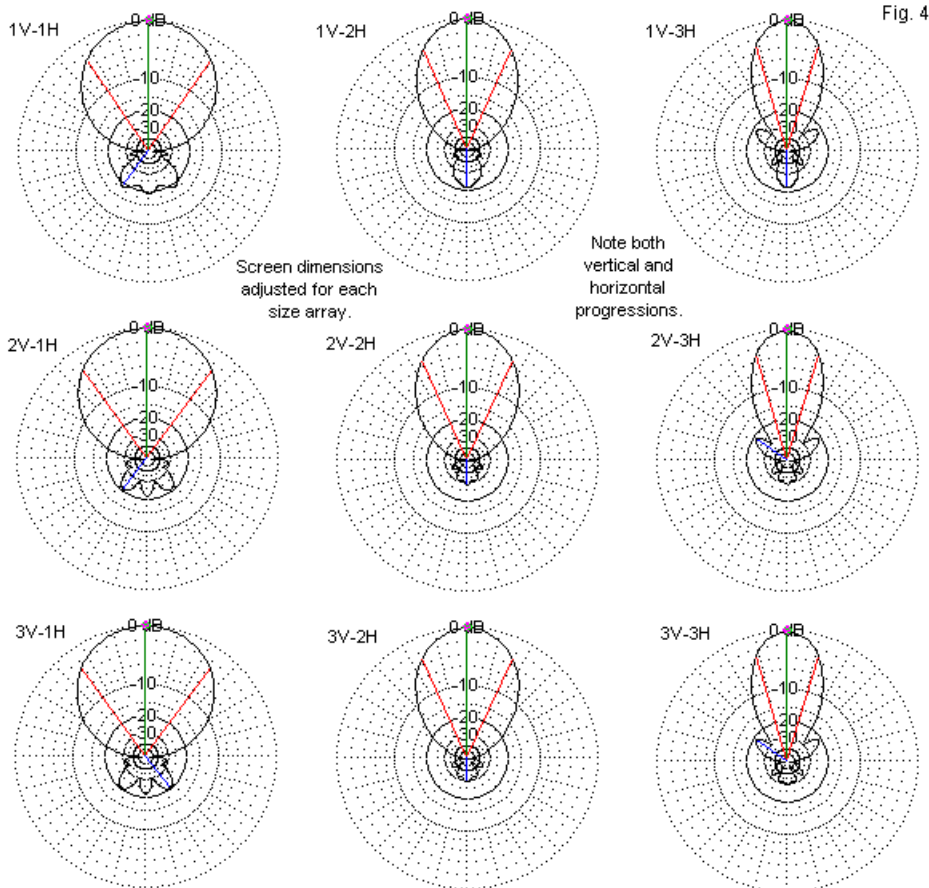

Free-Space E-Plane Patterns of Typical Dipole Arrays with a Screen Reflector

A number of features of the patterns call for note. The beamwidth values do not change very much from the values without the reflector, except that they apply only to the single large forward lobe. The sidelobes of the versions with 3 horizontal dipoles are better than 20 dB lower than the main lobe regardless of the vertical stack size. A single bay consisting of 1 to 3 dipoles arranged either vertically or horizontally has a good front-to-back ratio. However, as soon as we add a second bay in one or the other direction, the ratio approaches 30 dB--even for the 2V-2H version of the array. For values over average ground with a base height of at least 1/2 wavelength, you may add about 5 dB to the gain for a ballpark total gain figure. The gain will slowly climb as we increase the base height of the array, of course, moving the screen upward with the dipoles.

One advantage that accrues to the dipole array is the ability to shift or slew the main direction of the beam by up to 30 degrees each way, depending on array size. Common installations employ "delay lines" that shift the phase angle of the current for each vertical bay of dipoles. We may simulate this effect in models simply by using a current source and adjusting the source phase angle while holding the current magnitude constant. **Fig. 5** shows the patterns for a 1V-2H array initially with both vertical dipoles in phase. The center pattern uses a phase angle of 30 degrees for the first dipole and 60 degrees for the second. The final pattern uses 60 degrees for the first dipole and 120 degrees for the second. The general rule is to change the phase angle of subsequent vertical dipole bays by a multiplier on the baseline phase angle according to the position of



the dipole (or vertical bay of dipoles) relative to the first vertical dipole or bay.

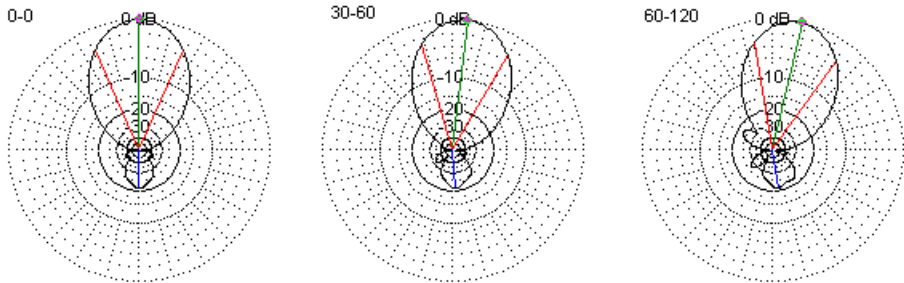

Slewing the Dipole Array Pattern  
1V-2H Array Used in This Sample

Fig. 5

The first move changed the heading of the main beam by 7 degrees, and the second changed it by 13 degrees. The angles would remain the same regardless of the size of the vertical bays in the array. By the correct selection of delay lines, we can achieve a relatively precise aim at a target of choice within the span of allowable slew angles. As we increase the angle of the main beam by these means, some distortion does appear in the form of forward and rearward sidelobes. At the angles in the sample, the distortions are not severe enough to void the use of slewing. However, they show that slewing has limits. Nevertheless, for a SWBC station that wishes to change its target from one session to the next, the process allows the change without physically altering the antenna or its position. Note that, when used within limits, the beam strength and beamwidth do not change to any noticeable degree.

The basic capabilities of a fixed position dipole curtain array are quite impressive, even using the ubiquitous amateur monoband Yagi as a standard of comparison. A 2V-2H assembly at a reasonable height above ground would easily match a 5-element Yagi, and delay-line slewing of the beam would permit coverage of all of Europe from the eastern U.S without need for a rotator. If we built equivalent dipole arrays on each side of the reflector, then we might cover Europe on one side and the Pacific on the other, at least from my location in the hills of Tennessee.

## Broadbanding Techniques

The needs of SWBC stations are quite different from those of the average amateur station. SWBC stations tend to use very high power levels, up to 500 kW in some cases. Since we must provide energy to each dipole, the use of wide-spaced parallel transmission is fairly standard, indicating as well the use of high-impedance antenna feedpoints. A folded dipole of conventional construction--with equal diameter conductors throughout--goes part of the way toward the high-impedance goal. However, if we wish to raise the feedpoint impedance beyond about 280 Ohms, we must resort to more unconventional techniques. For example, if we use a smaller diameter wire for the line with the feedpoint and a much larger diameter wire for the other line, we increase the impedance transformation to almost any desired level within the limits of lines to match it. We may simulate very wide second wires using pairs or cages of wires so that the entire assembly remains lighter than it would be with a single fat wire or tube for the second conductor.

Obtaining a high impedance feedpoint does not resolve a second goal of dipole array designers: achieving a wide operating bandwidth. The gain of a dipole array changes slowly as we change the operating frequency as a function of the length of the elements relative to the operating frequency. However, being able to match the array over an extended bandwidth requires a combination of techniques. There is no magic to any of them, although amateurs rarely use them in complex combinations.

The first step is to begin with a wide-band folded dipole. The AWG #10 folded dipole used in our initial dipole array models has a 2:1 SWR bandwidth that runs from 9.6 to 10.5 MHz, a 0.9-MHz spread (given our test frequency of 10 MHz). We need to begin with a folded dipole array that has inherently a broader operating bandwidth. That is step 1 in the process. Most dipole array manufacturers have proprietary designs for their driven elements, designs to which I am not privy. (Even if I had access to one or more of them, I likely could not violate agreements that gave me such access.) So I shall begin with a moderately broadbanded driver of my own design. It will not have the full capability of some commercial driver elements, but it will be sufficient for our small demonstration.

A Fan-Folded-Dipole

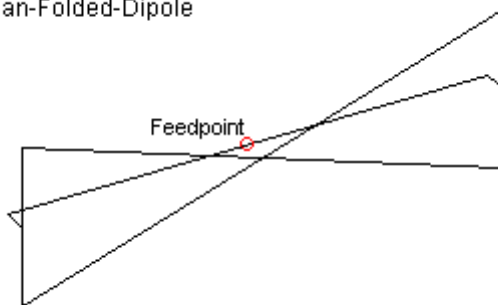
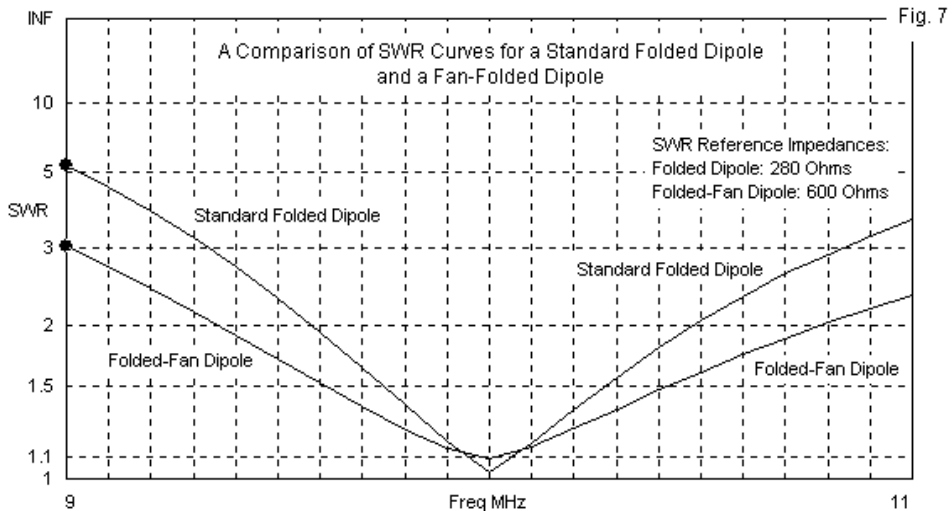

Fig. 6

A fan dipole with a 3:1 length-to-height ratio is capable of increasing the operating bandwidth over a conventional linear dipole. However, the feedpoint impedance is about 50 Ohms. If we create a pair of such fans, we only achieve the standard 4:1 impedance increase that is standard for a conventional folded dipole. However, if we use a single-wire as the fed portion of the folded dipole, the fan represents a much "fatter" second portion, for a significant increase in the feedpoint impedance. We connect the fed wire to the fan at the centers of the vertical sections, since that is the pair of points on the fan with minimum current. The free-space performance data for the arrangement is virtually identical to the standard folded dipole, but the feedpoint impedance at resonance is over 550 Ohms. A 600-Ohm SWR curves shows under 2:1 SWR from 9.4 to 10.8 MHz, a 1.4 MHz spread or about 1.56 times the spread of the standard folded dipole. Like the standard folded dipole, the folded-fan dipole is composed of AWG #10 copper wire in all of the models that we shall consider. **Fig. 7**

overlays the SWR plots for the standard folded dipole and the folded-fan dipole. Each curve uses its own reference impedance.



Step 2 in the process of broadening the operating bandwidth is to place the driver assembly ahead of the reflective screen and determine the best distance between the two. Like previous screens, the wire-grid structures used in this sample situation extend about 1/2 wavelength beyond the driver limits in all directions. **Fig. 8** shows side and face views of the folded-fan dipole and its screen. In the EZNEC graphic, I have retained the segment and wire junction dots to lend some color differentiation to the array pieces.

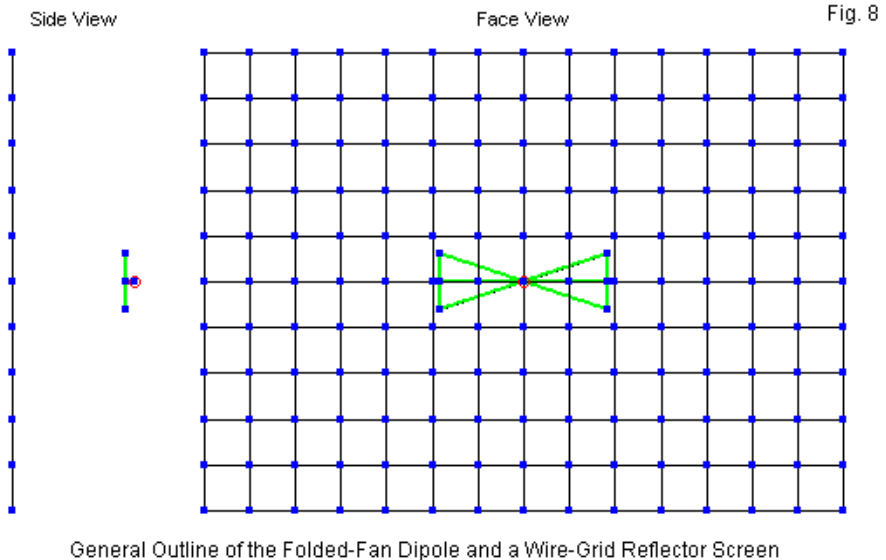

**Fig. 8** shows no spacing value because I examined 2 cases. The first placed the driver 0.245 wavelength ahead of the screen. The free-space gain was 8.34 dBi with a front-to-back ratio of 18.77 dB. The feedpoint impedance with this spacing was close to 800 Ohms. Increasing the distance between a planar reflector generally has 3 easily noted effects. First, it raises the feedpoint impedance of the driver. Second, if the distance is greater than the maximum gain position, performance gradually declines relative to both gain and front-to-back ratio. Finally, increased spacing between the driver and screen tends to widen the operating bandwidth of the array. By increasing the spacing between the driver and screen to 0.3 wavelength, the feedpoint impedance rose toward 1000 Ohms.

However, the maximum free-space gain dropped by 0.9 dB to 7.45 dBi, while the front-to-back ratio fell to 16.55 dB. Nevertheless, as shown in **Fig. 9**, the small increase in spacing widened the 2:1 SWR bandwidth, with each array design using its own reference impedance.

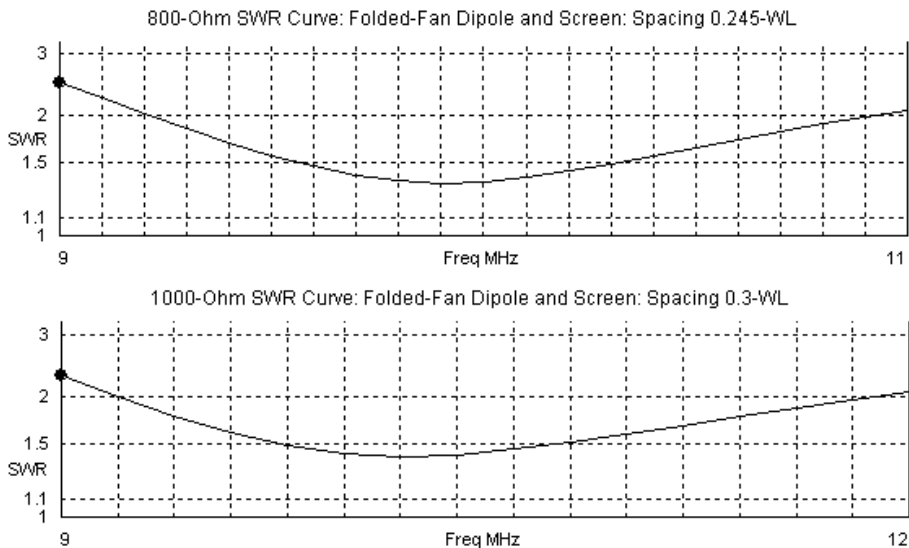

Fig. 9

Although the curves appear similar, note the difference in the frequency limits of each graph. At a more optimal position for array gain, the passband runs from 9.2 to 10.9 MHz or 1.7 MHz. By increasing the spacing, the operating passband now extends from 9.2 to 11.9 MHz or 2.7 MHz. Notice that the SWR in neither case

reaches a 1:1 value. That goal is often only an amateur fetish (but is not always a fetish by any stretch of the imagination). By selecting an acceptable reference impedance--generally one that reflects a transmission line that we can use with the system--we can often attain a wider passband within the upper limits of allowable SWR.

Stretching the operating passband in terms of SWR does not guarantee that the array pattern will be equally usable everywhere within the frequency limits. **Fig. 10** presents sample E-plane patterns from the wider passband, using the upper, lower, and mid-band frequencies. Within the span of the antenna, the gain drops from 8.04 dBi down to 5.02 dBi as we raise frequency (and the spacing becomes wider as a function of a wavelength). The 180-degree front-to-back ratio tends to be stable in the 16-18-dB region. However, as we raise the operating frequency, the beamwidth broadens, especially toward the upper passband limit. At 11.9 MHz, the pattern shows twin peaks, although there is no noticeable null between them. However, for some applications, the beamwidth may have become too wide to meet operating criteria.



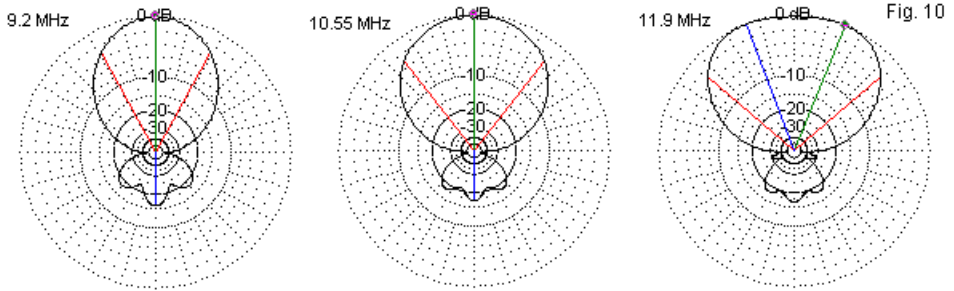

E-Plane Patterns: Folded-Fan Dipole Plus Screen, 0.3-WL Spacing to Screen Reflector

Our step-2 exercise has increased the frequency range for allowable operation. In the process, the exercise has also shown us that not every frequency that we can use is one that we can use well.

The third step on the road to broadening the passband of a dipole array involves what happens when we phase-feed more than 1 driver. For this rudimentary demonstration, I set 3 folded-fan dipoles (without a screen) at vertical intervals of  $1/2$  wavelength. The center dipole serves as the fed driver relative to the main transmission line. Each outer driver receives energy from a  $1/2$ -wavelength transmission line connected to the center driver. The three drivers are now roughly in parallel. Hence, we can expect a reduction in both the resistance and the reactance at the feedpoint.

However, the drivers interact with each other. Outer drivers essentially interact with only one other driver, and mutual coupling shifts the feedpoint impedance of each of them by like amounts.

However, the center driver mutually couples to both outer drivers and shows a different shift in impedance from the value it would have if used in isolation. By judicious sizing of the drivers we can overcome the impedance difference. However, let's size them in concert, that is, make them all the same size. The left portion of **Fig. 11** shows the set-up in outline form.

Fig. 11

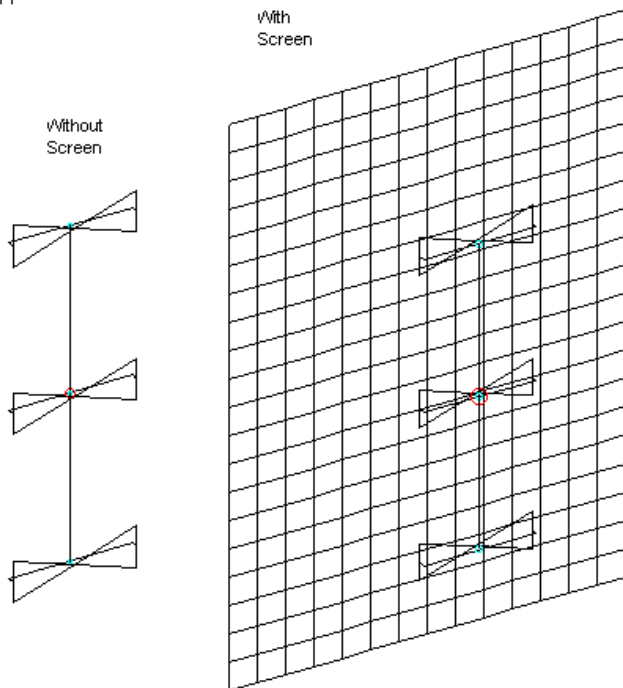

General Outline of 3 Folded-Fan Dipoles and Phase Lines  
with and without Screen Reflector

Because the impedances on the outer drivers will be increasing for part of the frequency sweep while the center driver impedance decreases--and vice versa--we obtain an additional increment of passband broadening. **Fig. 12**, at the top shows the new passband, which even without a reflective screen extends from 9.55 to 11.8 MHz or 2.25 MHz. The reference impedance for the curve is 250 Ohms.

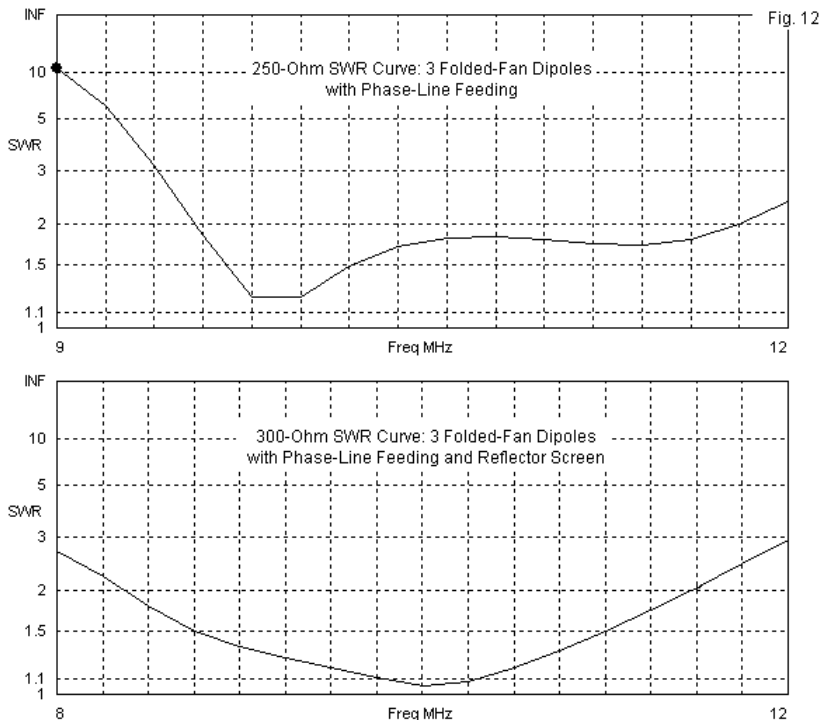

The bi-directional maximum gain of the drivers across the operating passband increases from 7.17 dBi to 8.03 dBi, with well-behaved lobes. Therefore, the driver set seems fit for combining steps 2 and 3, that is, using a phased set of 3 drivers ahead of a screen. The right portion of **Fig. 11** shows the ultimate array (at least for our demonstration) in outline form. The lower portion of **Fig. 12** reveals the 300-Ohm SWR passband, which now extends from 8.35 up to 11.5 MHz or 3.15 MHz. The following brief table samples the modeled free-space performance values at each ends of the passband and at the mid-band frequency.

Modeled Free-Space Performance of a Vertical Stack of 3 folded-Fan Dipoles  
0.3 WL Ahead of a Screen Reflector

Frequency (MHz)	8.35	9.925	11.5
Maximum Forward Gain (dBi)	11.99	11.86	10.99
180-Degree Front-to-Back Ratio (dB)	19.81	20.15	20.00
E-Plane Beamwidth (degrees)	58.9	68.8	95.8

Except for not showing relative gain values, the patterns in **Fig. 13** put a graphic face on the data in the table.

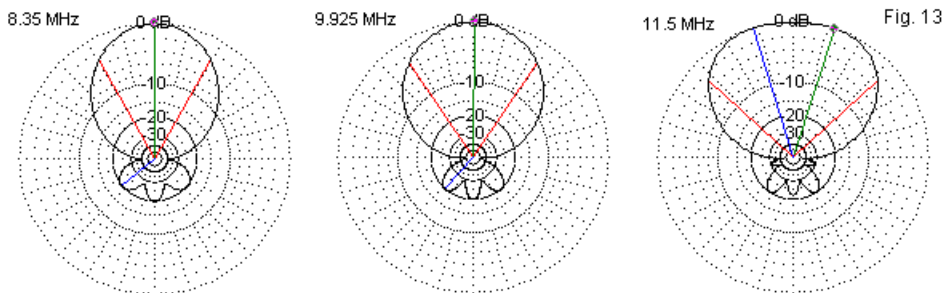

E-Plane Patterns: 3 Folded-Fan Dipoles with Phase-Line Feeding and Reflector Screen

The array patterns show the same sort of development that we found in **Fig. 10** for a single driver and screen. At the top of the passband, we find dual peak gain levels, but without a noticeable null between them. We also find a rapid rise in the beamwidth above the mid-band frequency--nearly 30 degrees. Although the same cautions apply to the expanded array as also apply to the single driver array, we should note that the operating passband is now about 50% greater.

Our goal has been only to demonstrate that obtaining a wide operating passband from a dipole curtain array requires a combination of ingredients or steps, as we have called them. The folded-fan dipole is far from being the ideal starting point for effecting the scheme, although it has served well in the demonstration. Some manufacturers of dipole screen arrays claim up to a 2:1 frequency range while also listing tighter SWR limits in their specification sheets. However, all specification sheets are incomplete performance records, so we have no idea of whether the patterns associated with frequencies across a given frequency range are all usable to the same degree as they are at mid-band.

Regardless of the performance obtained by any given maker, we have seen that through careful design (even at the crude level used in this exploratory account), a dipole array with a screen reflector lends itself to broadband service with gains that one might tailor by selecting the correct array size. A planar reflector, whether solid or composed of lines or screens, offers considerable flexibility in system design. If we give up the amateur habit of always seeking

the highest gain from the fewest elements, we can achieve a number of other advantageous performance features in our arrays.

## Back to the Billboard

Modern screen or curtain arrays employ dipoles. However, in the dim recesses of past times, the original standard driver billboard array was one or more sets of center-fed 1-wavelength elements, also called collinear half-wavelength elements. We neglected to test this arrangement to see if it offers any advantage over the use of dipoles. Let's pause before closing to see what happens if we replace dipole drivers with the 1-wavelength drivers.

To gain some perspective on the question, let's use a 2V-2H dipole driver set as one comparator. The corresponding billboard array would employ a 2V-1H driver set. Both driver arrays would have the same dimensions and require the same size reflector screen. In fact, we may also use the same spacing between the drivers and the screen for both antennas. The top portion of **Fig. 14** shows the two outlines.

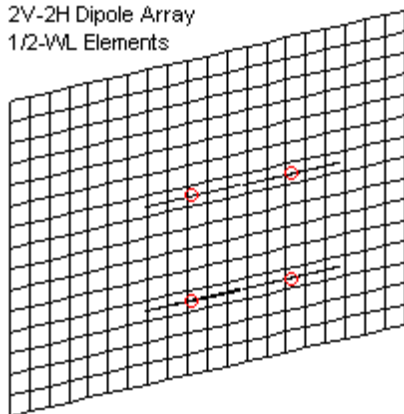
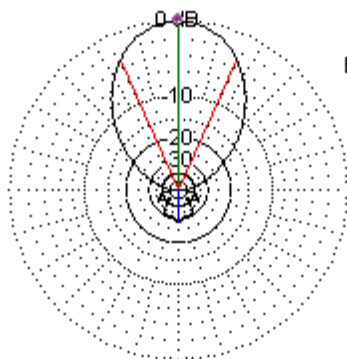
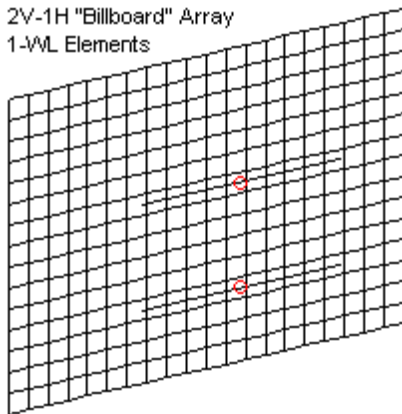
2V-2H Dipole Array  
1/2-WL Elements2V-1H "Billboard" Array  
1-WL Elements

E-Plane Patterns

Comparison of a 2V-2H Dipole Array and a 2V-1H "Billboard" Array  
Using the Same Screen Reflector and Spacing

Fig. 14

Between the two types of driver arrays we find under 0.1-dB difference in gain and only 1 degree difference in beamwidth. The front-to-back ratio of both arrays is near 28 dB. As the sample E-

plane patterns show in **Fig. 14**, Nothing in either pattern gives one or the other array an advantage.

We have already explored some ins and outs of dipole impedance behavior in a planar-reflector array. The older billboard system shows individual feedpoint impedances that are very high--in excess of 3000 Ohms resistance. For a single frequency, the high impedances are no hindrance to the use of 1-wavelength elements. However, if we wish to change frequencies, we may encounter a need to retune the system. The center of a 1-wavelength element is a region of very large and rapid changes of impedance values as we shift the operating frequency. Unless all wires composing the system are very taut, storm winds may result in some impedance oscillations.

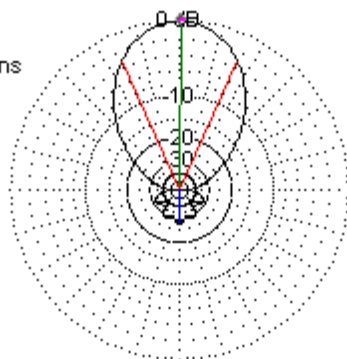
The much lower impedances of dipoles--even raised to several hundred Ohms--provide the array designer with a much more controllable situation with respect to impedance matching over a wider frequency range. The conversion to dipoles as drivers has made the dipole screen array a mainstay of short-wave broadcasting by providing the necessary gain and beamwidth (including slewing) with the ability to handle high power levels. Increased operating bandwidth supplies the final need of the SWBC industry.

In these notes, my aim has been to examine some of the features of an antenna type that we often encounter on our travels across the U.S., but seldom have occasion to use personally. The maze of wires--whether active antenna parts or support guys--gives these



antennas an air of mystery--or at least considerable puzzlement. (Of course, not all mazes of wires strung between 2 tall support masts are dipole curtain arrays.) Hopefully, this small set of exercises has taken some of the mystery out of the arrays.

In the course of developing these notes, I have used published information on the antenna type, abetted by some first-order free-space modeling. Hence, my slant on certain features may differ markedly from the perspective brought to bear by an antenna engineer deeply involved in the design and implementation of such arrays. Indeed, I may well have overlooked numerous features that a manufacturer might consider critical and stressed others considered marginal or even trivial. Still, I hope that these notes contain enough analytical information to make the antenna type--the dipole curtain array--more familiar to and understandable by those who see one for the first time.

## Chapter 47: The 2-Element Vertical Phased Array

In July, 2006, Pete Millis, M3KXZ, published his design of an array of 2 vertical antennas that he calls "'No-counterpoise' antenna: 2-element phased array.

The antenna is interesting in several respects. First, it uses a very simple structure and common materials that you can obtain from Radio Shack and hardware sources. Pete uses speaker wire and PVC supports for the vertical elements. Perhaps the only specialized antenna items are the baluns that he winds on ferrite cores and the encased 4:1 balun he uses at the center of the 2-element version of his array. However, we shall have occasion to evaluate the need for these items as we look into the antenna.

The second significant aspect of the antenna is its performance. A single element length covers a spread of bands, for example, 20 meters to 6 meters using a total length of 25'. The normal limit for either a 1/4-wavelength monopole or a 1/2-wavelength dipole is about 2.5:1, which would suggest a cut-off of about 35-36 MHz, if the original antenna is cut for 14 MHz. Once a monopole exceeds about 5/8-wavelength or a dipole exceeds 1-1/4-wavelengths, the main radiation is no longer broadside to the wire. For a vertical antenna, the long lengths result in very high angle radiation, rather than the low angle radiation that we normally need. However, the M3KXZ antenna and array yield very usable patterns from 20 through 6 meters. In addition, the gain of the antenna is close to the gain available from either vertical dipole/doublets or from elevated monopoles with radials on all bands.

For these reasons, it seems that the antenna in both its 1-element and 2-element versions deserves a closer look, if only to understand its operation better. As well, if one wanted to replicate his antenna using different materials, we shall need to look at some of the pieces in his arrangement.

## A Frame of Reference

As a basic for evaluating the behavior and performance of the M3KXZ antenna and array, let's first catalog comparable data for a more familiar antenna, the straight vertical wire element. Since we shall look at the 20-6-meter version of the M3KXZ antenna, we may cut the wire for 20 meters. We shall use AWG #12 copper wire and place the lower end 1' above the ground, the height that we shall use for the other elements. However, a straight wire that is vertical requires a top height of 34.6'. For our basic work, we shall use average ground as the soil throughout.

We have 3 choices for feeding our vertical wire. We might select the center, which would be natural for a 1/2-wavelength dipole. Of course, the wire becomes a doublet as the length grows longer than 1/2-wavelength and the current peak and voltage minimum no longer occur at the center of its length. Alternatively, we might select a feedpoint based on the M3KXZ design, that is, a position 2/3 of the distance down from the antenna top, considering the 12.5' fold back in the M3KXZ design as the lower 1/3 of the antenna. Finally, we might place the feedpoint at the lower end of the antenna.

**Table 1** summaries some of the key performance data for each of the three versions of the vertical wire at the center of all amateur bands from 20 through 6 meters.

Performance Data: Single Full-Length Dipole/Doublet					Reference Data for Comparisons										Table 1	
Center-Fed					Off-Center-Fed 1/3rd Up					End (Bottom) Fed						
Freq MHz	Max Gn	TO deg	Feed R	Feed X	Max Gn	TO deg	Feed R	Feed X	Max Gn	TO deg	Feed R	Feed X	Max Gn	TO deg	Feed R	Feed X
14.175	0.16	19	93.5	0.5	0.25	19	119.3	-0.9	0.37	19	3096.0	-14360.0				
18.118	0.65	16	193.4	420.7	1.07	16	4191.0	691.6	1.31	16	116.8	-11640.0				
21.225	1.00	15	399.4	857.5	1.65	14	3077.0	-217.5	3.00	46	78.9	-9556.0				
24.94	1.41	13	1379.0	1642.0	3.95	40	229.4	-641.8	3.72	39	222.2	-7666.0				
28.5	2.19	12	3807.0	-943.4	4.27	33	1540.0	-37.4	4.06	34	1972.0	-646.4				
52	5.81	34	646.1	912.9	2.22	18	204.1	-624.7	6.80	58	123.6	-3777.0				
Notes:	Vertical element AWG #12 copper wire 1' to 34.6' above average soil															
	Max Gn = maximum gain in dBi at the listed TO angle															
	TO deg = take-off angle in degrees															
	Feed R and Feed X = resistive and reactance components of the feedpoint impedance															

As we would expect, the feedpoint impedance values (Feed R and Feed X) differ widely among the antenna versions. More significant for eventual comparative purposes is the performance of each version. None of the three can sustain a low elevation angle for the main radiation lobe across the range of bands covered by the survey. Moreover, we find differences within each band depending on the feedpoint position, and the differences involve more than small changes in the maximum gain. For an example, we may use 24.94 MHz. The center-fed version produces a main lobe at 13 degrees elevation. The off-center-fed version's main lobe is at 40 degrees, while the end or bottom-fed version main lobe is at 39 degrees elevation.

The radiation pattern differences result from differences in the current magnitude distribution along the wire on this band--and on any other band where the wire is longer than 1/2 wavelength. **Fig. 1** shows the differences that occur on 12 meters. Most evident is that

the current minimum occurs ever lower on the structure as we move from center feeding to bottom-end feeding. As well, but to a lesser degree, the differences in the current curve between the off-center-fed and the end-fed version play a role in the ultimate shape and strength of the pattern lobes for the vertical wire.

Fig. 1

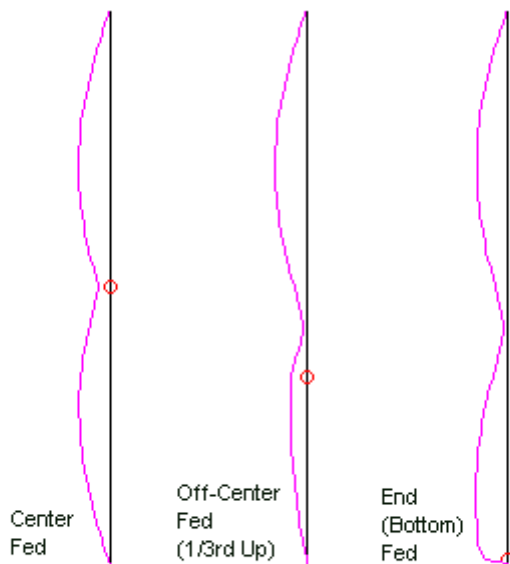

Current Magnitude Distribution on Reference Element  
at 24.94 MHz with Different Feedpoint Positions

Only the center-fed version of the straight wire doublet manages to cover 20 through 10 meters with the main lobe at a low elevation angle. The other versions give way to having their main lobes at

higher and generally undesired elevation angles well under 10 meters. Despite our interest in the radiation patterns, we shall also discover that the impedance columns of **Table 1** will hold importance as we attempt to see what lies behind the behavior of the M3KXZ antenna.

### Some M3KXZ Antenna Basics

The full 2-element array appears in **Fig. 2** in outline form. I have selected the 20-6-meter version for a detailed look. A single-element version of the antenna would simply omit the second element and the two phase-lines marked TL1 and TL2.

Main Elements of the M3KXZ 2-Element  
Phased Vertical Array

Fig. 2

In modeling the antenna, I departed from the original, which uses speaker wire. To yield adequate models, I spaced the AWG #12 copper wires 1" apart in the lower half. Parallel wires at this separation have a transmission-line impedance of about 400-450

Ohms. Although I have seen no tests of insulated speaker wires, the characteristic impedance of a pair is likely to fall into the 75-100-Ohm range, due to both the spacing and the relative permittivity (dielectric constant) of the insulation between them. In addition, Pete twines the wire along a length of PVC for support, but without introducing any significant inductance. Although we can view his elements as essentially straight, we should understand at the outset that all models will be only approximations of his antenna.

We should also enter a modeling caution to those who may wish to replicate the models used in this study. The separation between the long and the short sections of the element is 1". Although one would normally use 1" segment lengths for the remainder of the model, there is a different overriding consideration. Very closely spaced wires in NEC are subject to errors, even when we precisely align the segment junctions. In order to obtain a fair set of comparisons between the M3KXZ element and the straight wire element, it is necessary to adjust the segmentation to obtain an average gain test (AGT) score that is as close to 1.00 as may be feasible. For the models used here, 120 segments in the long section and 60 segments in the short section produced an AGT score of 1.004, indicating that gain and impedance values will be very much on a par with those drawn from the straight wire element with its essentially perfect AGT score. AGT values below near-perfect will yield low gain and high impedance reports, while AGT scores above near perfect will yield values that are too high for the gain and too low for the impedance. For very closely spaced wires, the segmentation density alone is enough to yield gain values up to

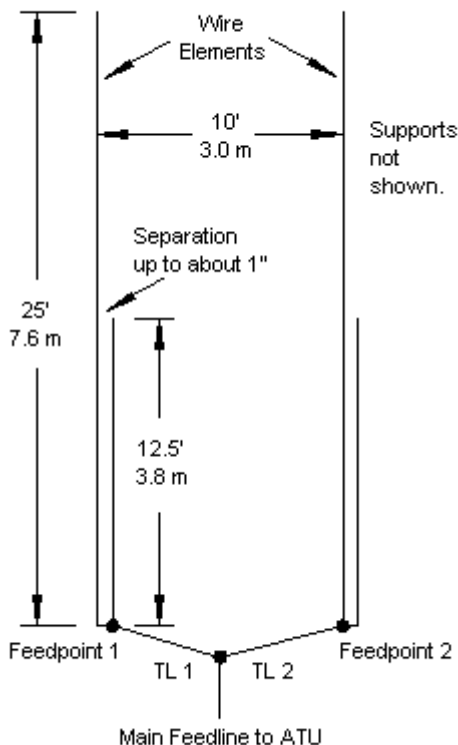

1.5 dB off the mark. Hence, close attention of the model's AGT score is essential, especially when comparing the performance of models have different geometries.

Before we turn to the full phased array, let's see what we might obtain from a single M3KXZ element. **Table 2** lists the NEC-4 reports from the model, which places the 25' element at a height of 1' above ground. I placed the antenna over a range of soils from very good to very poor in order to determine if the soil quality had a significant bearing on performance, given the close proximity of ground to the lower end of the element.

Performance Data: Single M3KXZ Element													Table 2	
Very Good Soil			Average Soil						Very Poor Soil					
Freq MHz	Max Gn	TO deg	Feed R	Feed X	Max Gn	TO deg	Feed R	Feed X	Max Gn	TO deg	Feed R	Feed X		
14.175	0.72	19	19.1	-54.6	-0.37	21	18.1	-55.3	-1.07	24	16.5	-56.2		
18.118	0.80	17	308.4	184.0	0.22	19	302.3	197.1	-0.22	22	306.3	216.4		
21.225	0.77	16	127.2	-101.8	0.52	18	125.9	-105.2	0.24	20	124.1	-110.4		
24.94	0.68	14	43.9	100.6	0.75	16	43.2	100.5	0.65	18	42.1	99.9		
28.5	0.57	13	38.1	286.7	0.90	15	37.7	286.8	0.97	17	36.9	286.7		
52	1.35	9	35.4	-118.1	2.25	9	34.7	-117.6	2.98	10	33.1	-117.2		
Notes:	Over very good soil only at 52 MHz, the element has a stronger lobe (3.76 dBi) at 50 degrees.													
	Max Gn = maximum gain in dBi at the listed TO angle													
	TO deg = take-off angle in degrees													
	Feed R and Feed X = resistive and reactance components of the feedpoint impedance													
	Soils:		Conductivity		Relative Permittivity									
	Very Good		0.0303 S/m		20									
	Average		0.005 S/m		13									
	Very Poor		0.001 S/m		5									

If we examine the gain and TO angle columns of **Table 2** under average soil, we discover that on all bands through 10 meters, the M3KXZ element yields competitive gain values and TO angles that are only slightly worse than those we gather from the center-fed straight wire. The M3KXZ element TO values are slightly higher largely because the top height is about 30% lower than the top height of the center-fed doublet. Nonetheless, all of the TO angles

shown in the table are suitably low, although they do vary with the ground quality.

There is an incidental but interesting pattern to note. We normally think of ground losses as increasing as soil quality decreases so that as we move toward bad soils, the gain of a vertical element decreases. However, this thinking has a frequency limit. The old thinking applies in small amounts from 20 through 15 meters. However, on 12 meters, maximum gain occurs over average soil. Above 12 meters, maximum gain occurs over very poor soil. The trend reversal is accompanied by a shrinkage in the differential in gain as we change soil, but the reversal is quite real.

Soil quality changes do not make a large difference in the feedpoint impedance at the antenna base, where the short and the long wires meet. However, the range of feedpoint impedances is considerable. Hence, the use of a coaxial cable between the antenna base and the antenna tuner may prove a considerable loss source unless the length is very short. With the possible exception of 10 meters, all of the impedances fall within the easily matched range of a remote antenna tuner placed at the element feedpoint. Otherwise, the use of parallel feedline--suitably elevated from the ground to prevent unwanted coupling--may be necessary. However, the very low impedance on 20 meters may incur some losses even with parallel feedlines.

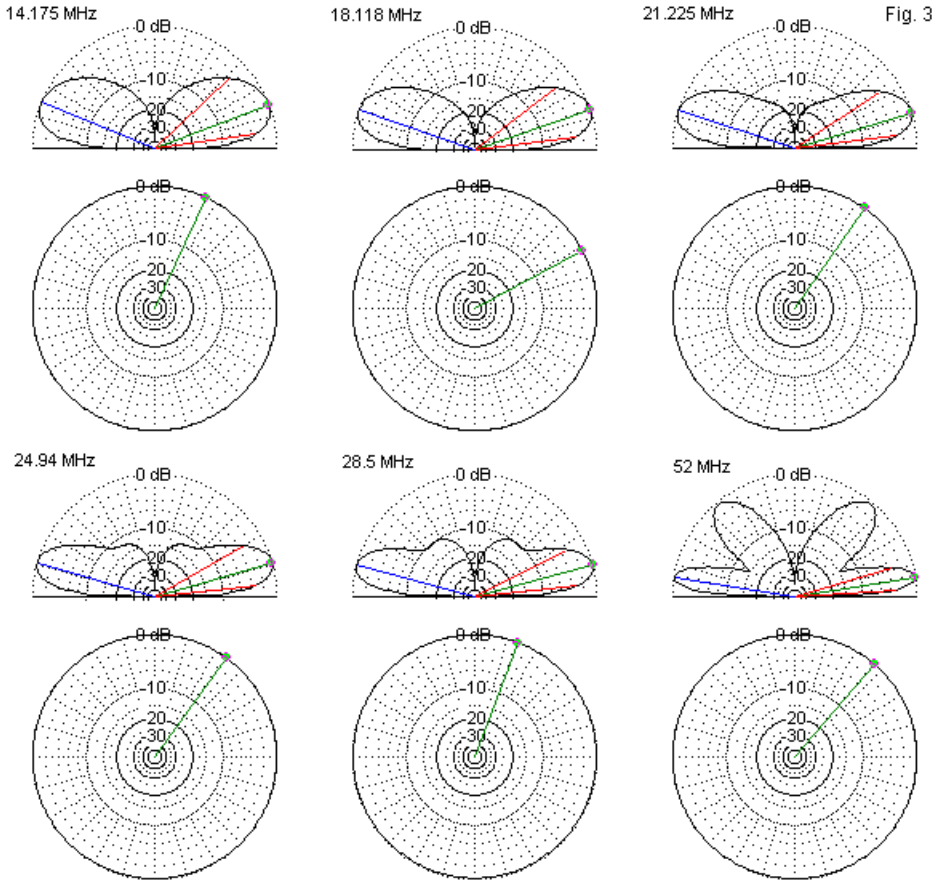

Elevation and Azimuth Patterns of a Single M3KXZ Vertical Element

**Fig. 3** provides a gallery of elevation and azimuth patterns for the bands covered by the array. Although the azimuth patterns all appear to be quite circular, note the shifting angle of the line that indicates the bearing of maximum gain. Any antenna with a fold-back--including the well-known J-pole--will exhibit at least a slight pattern distortion due to radiation from the two wires in the fold-back region. The closer that we space the wires, the less will be the distortion, and with the 1" spacing, the differential is never more than about 0.03 dB. However, as the shifting line bearings show, the distortion will change a bit from one band to the next. The fact is not operationally significant, but will prompt some further investigation.

The elevation patterns reveal one of the most essential aspects of the antenna's performance, the well-behaved radiation at low angles with very little higher-angle radiation until we reach 52 MHz. At the upper limit of the operating spectrum, the second elevation lobe nearly equals the gain of the lower lobe over average ground, and over very good soil, the second lobe at an angle of 50 degrees is actually stronger. However, the low-angle gain remains serviceable. For comparison, a straight vertical dipole fed 1/3rd of the way up its length shows a considerable upper-angle lobe on 15 meters, and at 12 and 10 meters, the higher second lobe dominates the pattern.

The well-behaved patterns are one of the effects of the 12.5' fold-back. That fold-back is not just a convenient way of feeding the antenna at a point 1/3 of its total length (25' plus 12.5'). For example, if we feed a 20-meter vertical dipole at the 1/3rd point, we

obtain resistance values ranging from 100 to 3100 Ohms, and reactance values from -600 to +700 Ohms. The values shown in **Table 2** are far tamer than they are for an off-center-fed straight dipole--or for any of the other versions of the straight-wire element in **Table 1**.

In fact, the fold-back forms a transmission line section that is 12.5' long. Whatever impedance appears at the junction of the single-wire top section and the beginning of the double-wire section undergoes a transformation according to the electrical length of the double section and its characteristic impedance. Note once more that modeling requirements have dictated a 1" spacing, and that the characteristic impedance is not the same as it would be for the speaker wire. Hence, the impedance numbers in **Table 2** are only representative. As well, they do not account for the transmission-line velocity factor of the insulated speaker wires used in the original.

**Fig. 4** presents a collection of current magnitude distribution graphs taken from the EZNEC models. At the far right, I have expanded the 20-meter graph in order to show that the current magnitude undergoes a small but noticeable shift at the point where the top single wire meets the double-wire section. The jog indicates that below the junction, the graph is showing a combination of both radiation and transmission-line currents.

Fig. 4

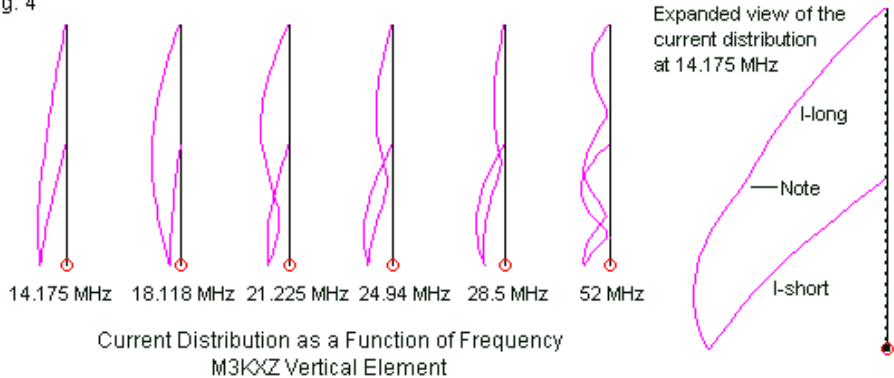

The remainder of the current magnitude graphs show that we should not try to apply a simplistic J-pole or end-fed Zepp model to the situation. As the patterns show, the junction between the top and bottom sections does not occur at a maximum voltage, minimum current point on any band. As well, the double-line length is not  $1/4$ -wavelength on any band, although it comes close on 10 meters. Therefore, the impedance transformation differs for each band in terms of both the impedance at the section junction and the amount of transformation that occurs in the lower section. One might use a number of means to roughly calculate the start and end values for the transformation, but given the higher characteristic impedance in the model relative to the speaker wire used in the original, such an exercise might prove to be operationally useless. For any given installation, the most practical effort is to measure the impedance at the feedpoint for every planned frequency of operation.

One consequence of the lower double-wire or transmission-line section is that the dominant radiation currents do not follow the patterns that they would in a straight dipole/doublet, whatever the feedpoint. Hence, M3KXZ has found essentially an antenna designer's grail or silver bullet: an arrangement of wires that extends the range of desirable pattern formation beyond its normal limits while sustaining good gain for an antenna of its type and leaving quite workable feedpoint impedance values.

## The 2-Element M3KXZ Phased Array

The 2-element version of the M3KXZ antenna, shown in **Fig. 2**, consists of 2 elements connected by equal lengths of a transmission line, with a common junction for connection to the main feedline. For the 25' version of the antenna, intended to cover 20 through 6 meters, the spacing between elements is 10'. The spacing is not accidental, since at 52 MHz, it represent about 0.53-wavelength, the maximum that we would wish to space phase-fed elements.

Since we shall ultimately feed the antenna at a center point between the two elements, we have two choices of phasing. We may connect the two lines so that each long-section wire goes to the same side of the junction for in-phase feeding. Alternatively, we may give one (and only one) of the two lines a half twist so that connections to long-section wires go to opposite junction points and thus end up with out-of-phase feeding. The original design used plugs and jacks at the center junction box to allow a quick reversal of the junction connections. A remote switch might achieve the

same goal with control transferred to the equipment location. **Fig. 5** shows the differences in the current distribution curves that result from the alternative feedpoint connections.

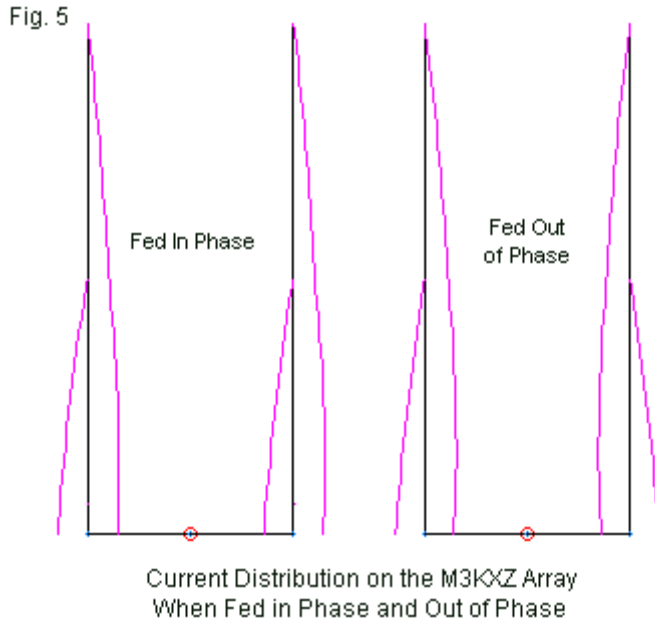

In-phase feeding of the two elements results in a broadside azimuth pattern relative to the plane of the two elements, comparable to the patterns that we obtain from converting a lazy-H into a standing-H. The gain yielded by the pattern over the gain of a single element is a function of the narrowing beamwidth in the plane of the array. The elevation pattern is not materially affected by the dual feed. How



much gain increase and beamwidth reduction we obtain is a function of the spacing between the elements measured in wavelengths at the frequency of operation. Gain increases slowly from virtually single-element performance at very close spacing to maximum with a spacing that is just over 0.5-wavelength. With an exact 0.5-wavelength spacing, the azimuth pattern is a perfect “figure-8.” Gain continues to increase with slightly wider spacing, but small sidelobes develop in the plane of the elements. Above about 0.55-wavelength spacing, the sidelobes grow so fast that the gain broadside to the antenna decreases.

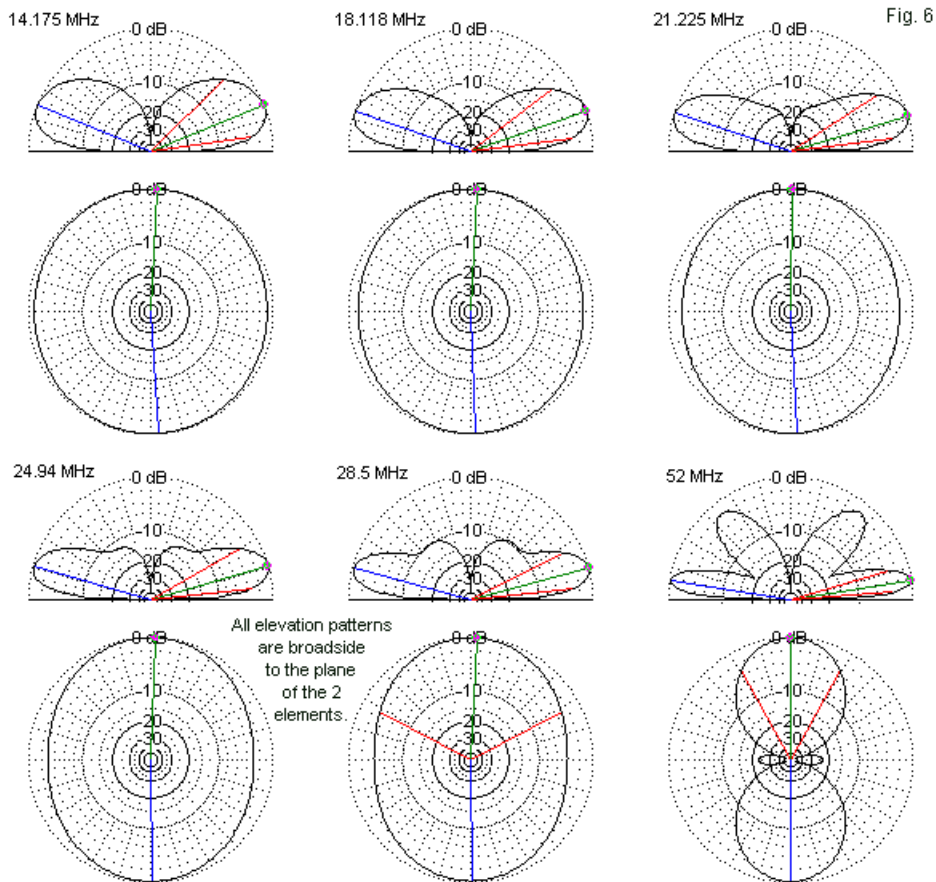

Elevation and Azimuth Patterns for the M3KXZ Array Fed In Phase

**Fig. 6** provides a gallery of elevation and azimuth patterns for the model of the 25' M3KXZ array with the 10' spacing between elements. Note that the elevation patterns, taken broadside to the plane of the two elements, do not differ significantly from the single-element elevation patterns. The azimuth patterns do not show relative gain values. Instead, each pattern uses the outer ring as the pattern limit to reveal more clearly the pattern shapes. If we look at the azimuth pattern for 52 MHz, we can see the beginnings of the sidelobes that develop as a result of the 0.53-wavelength spacing between elements. However, at lower frequencies, the spacing between elements is considerably less than the 0.5-wavelength ideal. As a result, as we move down in frequency, the patterns become more circular, indicating both broader beamwidth values and lower gain values. At 20 meters, where the spacing is only about 0.14-wavelength, we should expect--and we obtain--very little gain increase over a single element.

**Table 3** provides 2 sets of performance values, both sets taken over average ground. The left-most columns give the modeled gain and TO angle for the patterns in **Fig. 6**. You may compare these values to the values obtained for a single M3KXZ element over average ground in **Table 2**. At 20 meters, the gain advantage is only about 0.6 dB due to the close spacing of the in-phase-fed elements. At 10 meters, the gain advantage of the 2-element array increases to about 1.9 dB as the spacing increases to nearly 0.3-wavelength. At the more nearly ideal spacing of 6 meters, the gain advantage jumps to about 4.4 dB, with a commensurate decrease in the beamwidth of the two broadside lobes.

Performance Data: 2 25' M3KXZ Elements at 10' Separation						Table 3	
Freq MHz	Fed In Phase		Fed Out of Phase		Wavelen	Sep WL	
	Max Gn	TO deg	Max Gn	TO deg			
14.175	0.24	21	0.91	19	69.39	0.14	
18.118	1	19	2.47	18	54.29	0.18	
21.225	1.55	18	2.97	16	46.34	0.22	
24.94	2.17	16	3.25	15	39.44	0.25	
28.5	2.77	15	3.37	14	34.51	0.29	
52	6.64	9	4.23	9	18.91	0.53	
Notes:	See Table 1						
	Wavelen = wavelength in feet						
	Sep WL = 10' separation as a fraction of a wavelength						

The table's center columns provide modeled values for the performance of the array when fed out-of-phase by giving one of the two equal-length lines a single half-twist. The method of feeding is a simple evolution from the W8JK array that we usually see in horizontal form. The same principles apply. The antenna becomes a bi-directional endfire array with the main radiation in the plane of the elements. **Fig. 7** provides a gallery of elevation and azimuth patterns as they apply to out-of-phase feeding of the two elements with their 10' spacing. The elevation patterns are taken in the plane of the elements.

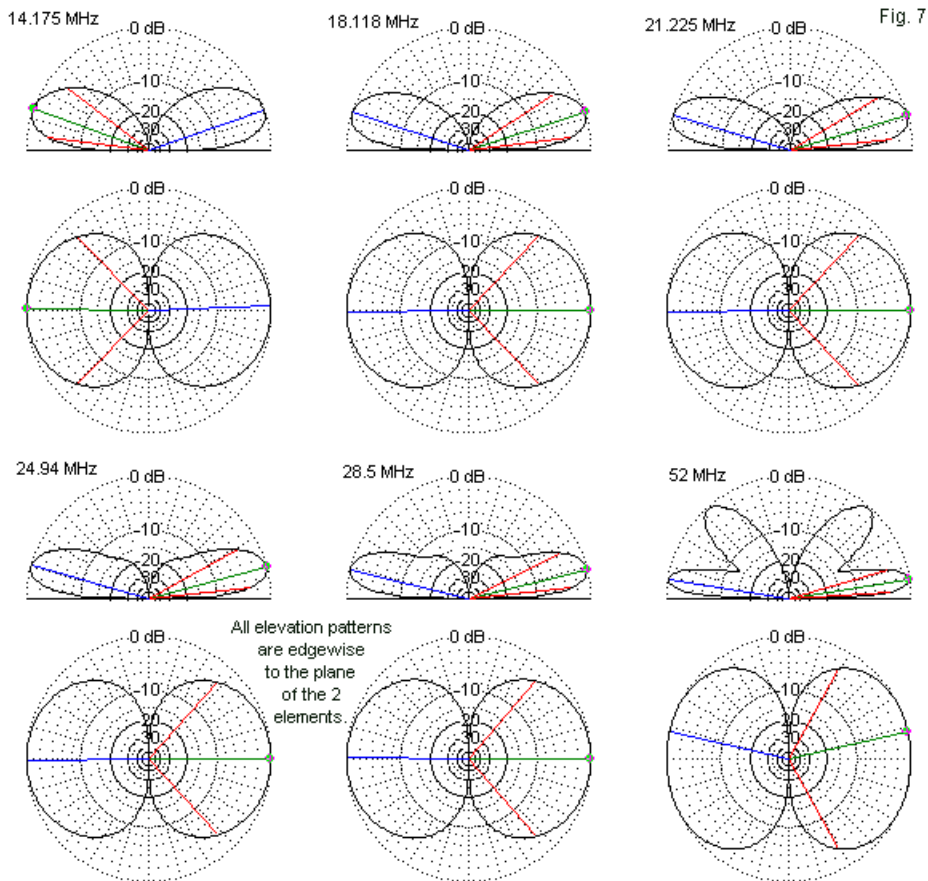

Elevation and Azimuth Patterns for the M3KXZ Array Fed Out of Phase

Except for the 52-MHz plot, the azimuth patterns all show comparable beamwidths. If we compare the out-of-phase gain values to the in-phase values, we find a sudden jump and a leveling off, so that we show only a slow rise in gain as we increase the operating frequency. The behavior of an end-fire out-of-phase fed array differs considerably from the in-phase-fed version. Two general rules apply. First, the closer the element spacing, the higher the gain will be over a single element. This trend gives precedence to 20 and 17 meters, where element spacing is closest. Second, the gain advantage increases as we increase the element length relative to an initial length. This trend gives precedence to the higher frequencies, where the M3KXZ elements are electrically longer. The broadening of the beamwidth at 52 MHz suggests that at higher frequencies (and therefore longer element electrical lengths), the pattern will break into 4 lobes, ruining the bi-directional characteristic of the antenna with out-of-phase feeding. The net result of combining the two trends is a much tighter grouping of gain figures for the out-of-phase version relative to the broadside in-phase version of the array.

The purpose of switching the phase of feeding is to obtain maximum possible gain from two fixed vertical elements in the direction of the signal. An in-phase/out-of-phase switch at the junction of the two lines marked TL1 and TL2 in **Fig. 2** provides a means of switching the axes of the bi-directional beaming. The beamwidths of the lobes in each version are complementary so that little or none of the horizon is excluded from performance equal to or better than the omni-directional patterns of a single element. Of

course, in the 2-element phased version of the M3KXZ array, the elevation patterns retain their low TO angles.

Thus far, the M3KXZ array displays considerable ingenuity in providing low-angle vertically polarized radiation over a wide passband. However, the array faces one final challenge: feeding the system and matching the junction impedance for either phase condition to the equipment. Here, we can use the modeled elements only with great caution. M3KXZ constructed his entire system with speaker wire, an inexpensive but dubious choice for outdoor durability. Speaker wires generally carry no rating for performance under the summer-to-winter weather extremes, and so the quality of such wires will vary from one maker to another, depending upon the quality of the insulation. In addition, such wires carry no rating for their characteristic impedance at RF frequencies. However, similar wires with standard "poly-plastic" insulations usually show an impedance in the 75- to 100-Ohm range. Due to modeling limitations, we have had to use a lower or double-wire section composed of bare wires 1" apart, for a characteristic impedance in the 400- to 450-Ohm range. Therefore, the impedance transformation that occurs in this section from the junction with the single-wire upper section and the end feedpoint will differ from the transformation obtained in the original version.

Adding phase lines to a central junction is another matter. We may sample a variety of lines, that is, a range of characteristic impedance values, by using the TL facility within NEC. The line impedance will not change the antenna radiation pattern, but it will change the impedance that we obtain at the junction of the two

lines under each of the phasing conditions. In creating a survey of values, I have simply used a velocity factor of 1.0 for two reasons. First, the element feedpoint impedance values are already off their marks if we use a double-wire section with a difference characteristic impedance. Second, common feedlines tend to come in several versions, each with a specific velocity factor.

Nevertheless, we can obtain a view of the type and size of the feedpoint impedance challenge using two 5' lengths of transmission line to a central junction. For the survey, I selected characteristic impedance values of 50, 75, 125, and 300 Ohms. The 50-Ohm value is for the most common variety of coaxial cable. 125-Ohms is the value for RG-63, a very useful but often overlooked cable. 75-Ohm covers both some common coaxial cables and so-called twisted pairs of insulated wires. 300 Ohms, of course, applies to common TV-type parallel feedline. **Table 4** provides the results of the survey, where R and X are the impedance components at the junction of the two cables (TL1 and TL2) under each phasing condition.



Impedance at Junction of TL1 and TL2 (See Fig. 1)										Table 4
In-Phase Feeding										
TL Zo	50		75		125		300			
Freq MHz	R	X	R	X	R	X	R	X		
14.175	6.5	-13.3	8.6	-10.8	11.1	-2.2	14.3	36.6		
18.118	20.2	-40.5	45.6	-53.9	105.9	-47.9	179.8	85.8		
21.225	13.8	-22.8	26.1	-26.1	50.5	-19.6	97.8	51.1		
24.94	21.8	-41.0	66.0	-64.1	200.3	-7.1	152.8	260.0		
28.5	1.9	-27.3	5.0	-48.1	19.9	-110.6	731.4	-716.8		
52	2.1	12.0	4.8	25.6	14.5	69.6	113.7	439.2		
Out-of-Phase Feeding										
TL Zo	50		75		125		300			
Freq MHz	R	X	R	X	R	X	R	X		
14.175	1.4	-8.3	1.8	-4.7	2.2	5.1	2.7	45.1		
18.118	3.5	-42.3	8.5	-66.5	27.5	-120.9	251.8	-330.1		
21.225	4.0	-15.2	6.7	-15.5	11.5	-9.2	21.7	40.7		
24.94	13.0	-62.2	71.9	-157.9	484.8	309.2	50.3	322.0		
28.5	0.6	-27.1	1.7	-47.8	6.7	-110.2	324.4	-1102.0		
52	4.5	12.8	10.6	27.5	32.0	75.0	255.9	464.7		
Notes:	R and X = resistive and reactive components of the junction impedance									
	TL Zo = characteristic impedance of the 2 phase-feed lines, using a velocity factor of 1.0									
	Possible lines:									
	Zo = 50: RG-8, RG-8X, RG-58, RG-213									
	Zo = 75: RG-11, RG-59									
	Zo = 125: RG-63									
	Zo = 300: TV-type twinlead									

The number of cases in which we obtain very low impedances, regardless of the characteristic impedance values for the phasing lines, raises a strong question about using a 4:1 balun at the junction of the two lines. Converting an impedance that is already well below 50 Ohms down to an even lower value seems to make little sense, especially if one uses the 50-Ohm main feedline shown in the originator's sketches. 4:1 baluns come in numerous designs, some of which may prove to suffer losses when used with high reactive components or when used outside the range of their

winding's characteristic impedance. The result may be artificially favorable impedance values at the terminals that may disguise what is actually occurring within the device. There are few values in **Table 4** that would benefit from even an accurate 4:1 downward impedance transformation.

In addition, the author uses 1:1 baluns supposedly to force equal currents on to the short and long sections. Actually, the current imbalance on each side of the feedpoint is part of what allows the array to achieve its broadband characteristics. A balun or choke might be more applicable at each element feedpoint if TL1 and TL2 are both coaxial cables, where transmission-line currents are inside the cable between the center conductor and the inner side of the braid, and common-mode currents are on the outside of the braid. Indeed, parallel transmission lines may not be the most ideal phase lines for the array.

The author also correctly notes that he obtains good impedance matches between whatever impedance the array presents at the junction--after transformation down the 50-Ohm main feedline--via his antenna tuner. We shall bypass any losses incurred by the impedance mis-match between the cable's impedance and the load impedance at the phase-line junction. The low-impedance loads, if transferred to a tuner, present challenges of their own.

Depending upon the type of network used, low-impedance loads sometimes result in acceptable but imperfect impedance matches, where the best obtainable SWR value at the tuner is perhaps 1.3:1 to 1.6:1. These conditions generally indicate a limit to the range of

the components within the tuner relative to the impedance at the terminals. In the table, note that many modeled values show much higher reactive components than resistive components. Although the match is acceptable, the efficiency of power transfer may not be as high as we too often presume. If the network has a low loaded or operating Q (Terman's "delta" term from the 1940s), we may find a difference in the settings required for resonance (that is, for zero reactance), for maximum power transfer, and for impedance matching. As the circuit's delta increases to about 10, these settings resolve to a single point. However, so long as tuners continue to lack any form of relative output indicator, we cannot easily tell if the impedance match that we obtain is also the point of maximum efficiency.

The junction of the two phasing lines is a balanced feedpoint. Ideally, the array might be fed at that feedpoint by a remote, balanced, weatherproof ATU with a very wide range of impedance matching capabilities. Such tuners are not generally available, although we can press existing components into service. In general, placing the tuner at the balanced feedpoint that joins the two phase-lines allows the use of a 50-Ohm cable to the equipment with minimum loss. At the input to the tuner we likely should install a common-mode current attenuator, such as an unun or a ferrite bead choke. System ground should occur at the equipment side of the unun or the choke, not either at the tuner output or at the tuner input. (The tuner input is likely to have a common ground system with the output, and we would want the tuner to "float." Grounding the braid of the coax at the equipment side of a ferrite bead choke would provide for static discharge.)

## **Conclusion**

The M3KXZ antenna and array constitute an ingenious arrangement of element parts that achieves low-angle vertically polarized radiation over an extended operating bandwidth that common configurations cannot match. The 2-element version of the array offers some gain and pattern shaping for bi-directional operating. Even with improved materials designed for both RF service and durability through seasonal weather cycles, the antennas are inexpensive. Moreover, they are relatively short for a given frequency range, adding to their neighborhood acceptability.

The challenges presented by the antenna and the array revolve around the matching and the feed system. Increased attention to these details may result in a very serviceable, wide-band vertical array.

## Chapter 48: The Terminated Vee-Beam and Rhombic

**T**he terminated longwire antenna is perhaps the simplest of the large terminated wire arrays, but it is not the best performer. In this session, we shall look at two arrays (other arrays to follow). The long, terminated Vee-beam provides considerably more gain for the same length legs, but does not have the longwire's ease of feeding over a large frequency spread. The rhombic, in contrast, provides gain even over the Vee-beam and allows multi-band coverage. However, it is perhaps the most complex of the terminated arrays.

Designing either type of array for maximum performance is not simply a matter of stringing hundreds of feet of wire. Behind each type of array are a number of design equations that take into account the length of the legs, the angles formed by the wires, and the antenna height (or desired elevation angle of maximum radiation). These notes only survey some of the potential of these wire antennas, but are not sufficient for designing an effective array for your own farm. Our goal is to provide enough information so that you may decide whether further study into the designs is a worthwhile project.

**The Vee-Beam:** Do not confuse the Vee-Beam with some of the small Vee-shaped antennas whose total wire length is only about 1/2-wavelength. We do not arrive in Vee-beam territory until each leg is several wavelengths long. Like the longwire antenna, the Vee-beam depends upon the fact that as we make a wire longer

and longer in wavelengths, the main radiation lobe moves from broadside to the wire to a position nearly in line with the wire.

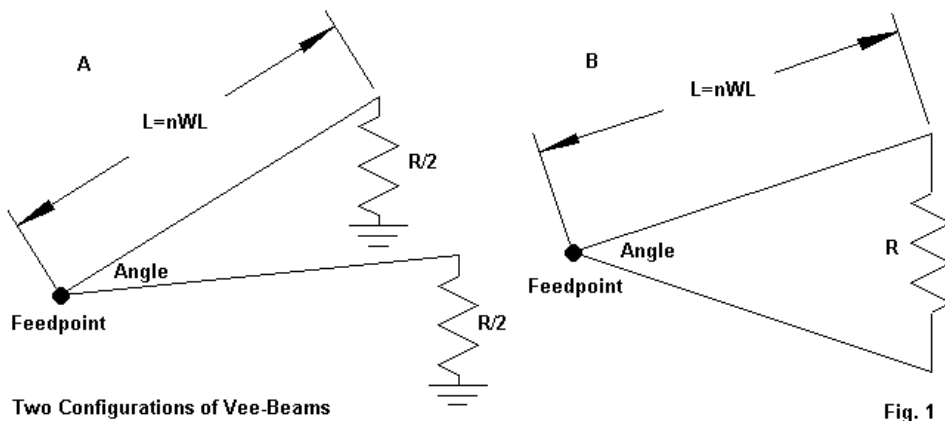

**Fig. 1** shows two ways of designing a terminated Vee-beam. One uses terminating resistors that operate like those in the simple longwire. The other uses a cross wire that includes the terminating resistor. Just as in the last episode, the terminating resistor must be a non-inductive element with the ability to dissipate about half of the power supplied to the antenna. Both versions of the Vee-beam use the same principle of operation.

To design a Vee-beam, we must know the planned length of the element legs in wavelengths. Since the length of the leg determines the angle of the main lobes relative to the plane of the leg, the length of the legs also determines the angle that we must use between the two legs for maximum forward gain. The goal is to

align the two legs so that a main lobe from each wire combines to form a single large forward lobe. See **Fig. 2**.

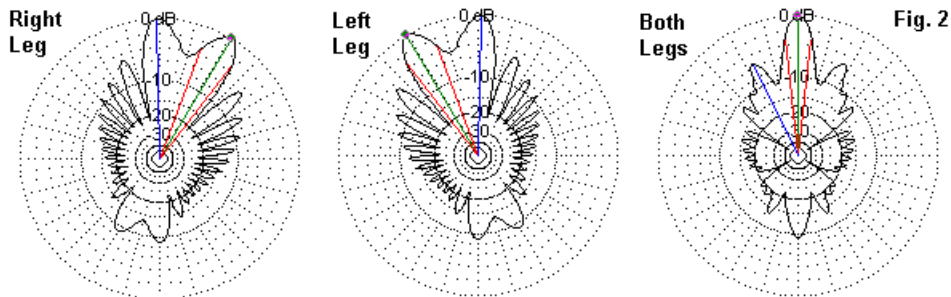

Evolution of the Long Vee-Beam Pattern

The plots show the patterns for the left and right legs of a planned Vee-beam with 7-wavelength legs. The height of the array is 1 wavelength above average ground. When we combine the two legs, we obtain the pattern at the right. For the leg lengths that we chose, the main lobes are about 15 degrees off the plane of the wire. By making a Vee with a 30-degree total apex angle, we approach the maximum gain of which the antenna is capable. Obviously, had we selected longer legs, we would have used a narrower apex angle, while shorter legs would have called for a wider angle. If we do not match the angles and the length of the legs, we shall obtain inferior performance.

With 7-wavelength legs, the Vee-beam yields a maximum forward gain over average ground of about 13.5 dBi. This value is considerably higher (by about 5 dB) than the simple longwire

antenna. However, the Vee-beam is not capable of achieving the high front-to-back ratio that the terminated longwire gave us. If you examine the two left patterns in **Fig. 2**, you will see that each has a rearward lobe that is less than 10 dB down from the favored lobe. In the Vee configuration, these lobes also add, giving the Vee-beam a significant rearward lobe that remains only about 10 dB down from the forward lobe. Like all arrays composed of wires that are several wavelengths long, the patterns will be filled with sidelobes.

Like the longwire antenna, the Vee-beam is capable of good use with or without its terminating resistors. **Fig. 3** gives us comparative patterns for the two versions, using the same legs. Only the presence or absence of the terminating resistors marks the pattern differences. Note that the unterminated Vee-beam has (like the unterminated longwire) about 2 dB more gain. However, it is more truly bi-directional (than the longwire), since the rearward radiation is down by only about 2.5 dB.



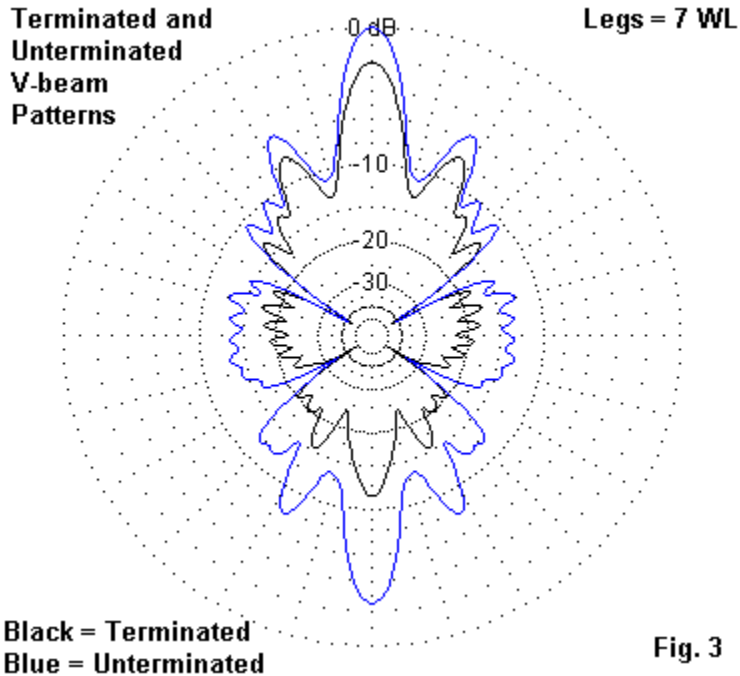

The unterminated Vee-beam is also a useful antenna. It does not require that we obtain suitable terminating resistors (400 Ohms each in the sample antenna). Therefore, only land, wire, and supports stand between us and an array of Vee-beams that can cover the horizon. **Fig. 4** shows the required number of Vee-beam legs needed, if we use the 7-wavelength legs and a 30-degree apex angle between legs.

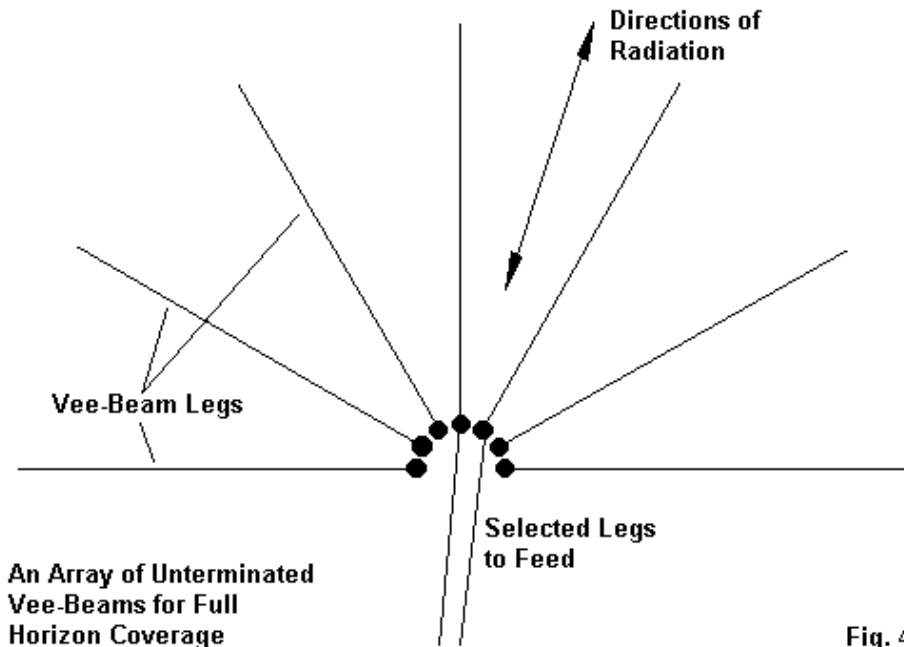

Fig. 4

We need outer-end (and perhaps intermediate) wire supports for each leg. However, we need only a single inner-end support for all of the legs. By a suitable means of switching--either at the antenna or near the shack, to which we bring a circular array of feedline wires--we select the adjoining pair of legs that gives us radiation in the two directions that we want.

The Vee-beam has some limitations. It is essentially a 1-band antenna, although we can press it into service on other bands.

However, as we move away from the design frequency, the legs change their length as measured in terms of a wavelength. That change moves the angle of the main lobe on each leg relative to the plane of the wire. Hence, on these distant frequencies, the lobes will not match to form as strong a main lobe. To sustain the higher gain and re-acquire the broadband characteristics, we need to use a different shape.

**The Rhombic:** The terminated rhombic antenna employs two sets of Vee-beams joined at the outer ends so that the second one forms a distant apex angle at which we install a terminating resistor. **Fig. 5** shows the general outlines of a rhombic. Each leg has a pair of main lobes, and the combination of the 4 legs produces a very strong forward lobe.

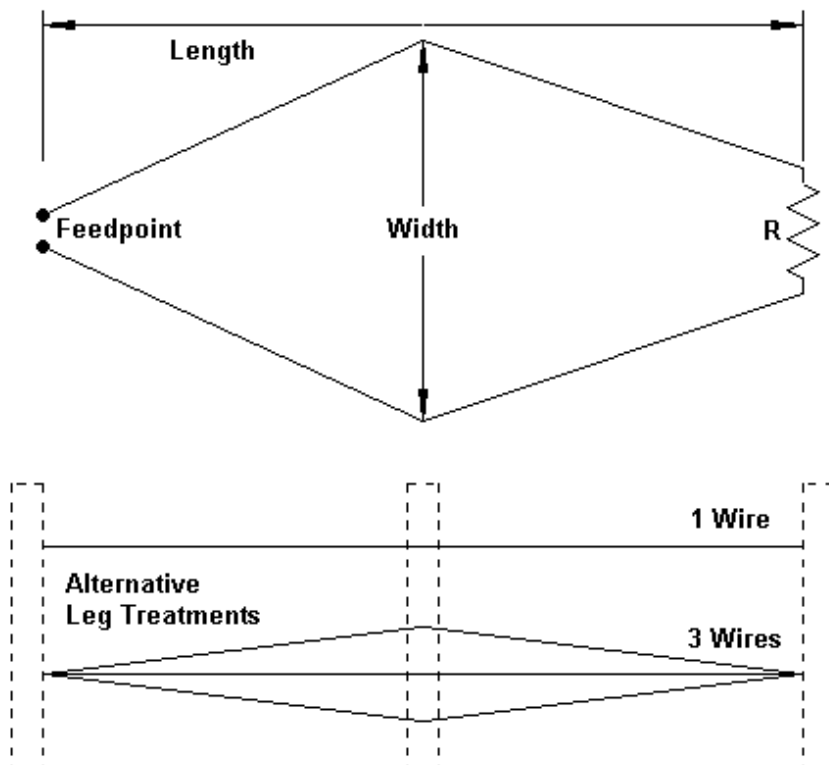

Rhombic Outlines

Fig. 5

The figure also shows in the lower half two ways of building a rhombic using either single-wire legs or triple-wire legs. Builders have reported improved performance with the three wires, although the 1-wire version is satisfactory for most amateur installations.

The rhombic is a venerable directional array for which design equations had been developed in the 1930s. The design equations take into account the elevation angle of radiation, as well as the proper combination of angles and leg lengths to produce a strong forward lobe and a good front-to-back ratio. Indeed, there are alternative equations for developing various compromise designs that combine antenna height, leg length, and angles in various ways. See John Kraus, *Antennas*, 2nd Ed., pp. 503-508, if you are truly interested in designing a rhombic that will fit your yard.

For many years, *The ARRL Antenna Book* has featured an interesting rhombic design suitable for use on the amateur bands from 20 through 10 meters. It employs a 600-Ohm terminating resistor and is a good match for a 600-Ohm transmission line. Hence, all matching can be done at the shack with a system of impedance-matching transformers or baluns or with an antenna tuner. **Fig. 6** provides a 600-Ohm SWR curve across the operating span to show the relatively good match between the terminating resistor and the feedpoint impedance.

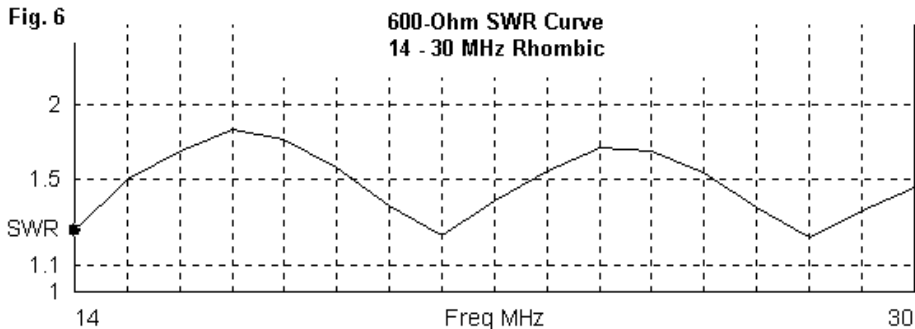

The rhombic is 377.5' long and 184' wide, with a 52-degree angle at both the feedpoint and the termination end. Of course, we shall require longer wire, since each side of the array requires about 420' of wire. If we set the rhombic at 70' above average ground--1 wavelength at 20 meters--we can anticipate the following performance figures.

**Sample Rhombic Modeled Performance**

Freq. MHz	Length WL	Height WL	Gain dBi	TO Angle degrees	Front-Back Ratio dB	B/W degrees	Feed Z R+/-jX Ohms	600-Ohm SWR
14.2	5.5	1	16.2	14	17.1	17	810 + j 60	1.4
18.12	7	1.25	17.8	10	15.3	13	1010 - j200	1.8
21.2	8.1	1.5	18.4	9	19.2	11	830 + j 60	1.4
24.95	9.5	1.75	18.3	7	15.2	9	990 - j 80	1.7
28.3	11	2	17.2	6	20.2	7	900 + j 40	1.5

Note that the array is optimized for 15 meters, where it shows the highest gain. However, performance is high on all of the bands. However, the array is not without some important limitations.

First, the array is fixed in position. We cannot re-aim it easily, if at all. We may combine this restriction with the second limiting factor: the beamwidth of the rhombic is very narrow compared to most wire arrays. The horizontal beamwidth, as measured to the half-power or -3-dB point is narrower than almost any other array. **Fig. 7** provides a band-by-band view of the azimuth patterns of the array to provide a sense of how narrow the beamwidth really is.

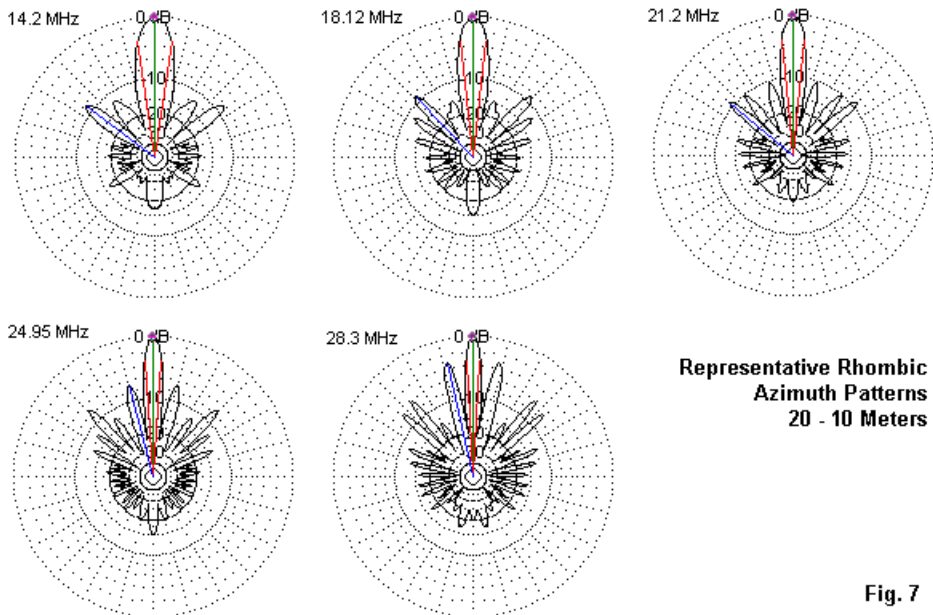

The earliest uses of the rhombic involved point-to-point communications circuits and well-defined broadcast target areas.

Contemporary use of the array should have some of these elements as part of the communications goals before deciding to erect a rhombic.

Rhombics have also seen use in the VHF range as outdoor television receiving antennas. More recent improvements in design techniques have produce double-loop versions that further suppress the side lobes that naturally occur with multi-wavelength element legs. Some amateurs have used these principles on bands as high as 1296 MHz.

The rhombic represents perhaps the pinnacle of refinement of large wire arrays. More recent developments in steerable arrays have largely supplanted the rhombic. However, the design still has adherents and users. It is likely to survive as an antenna option for generations to come.



## Chapter 49: The Controlled Current distribution (CCD) Antenna

The controlled current distribution (CCD) antenna has been around since the late 1970s. Every so often, it arouses a flurry of questions in my e-mail. So I decided to look into the CCD to see what we might reasonably expect of it.

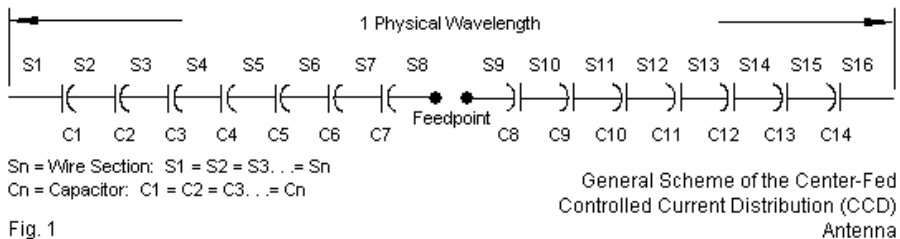

**Fig. 1** shows the general outline of the center-fed version of the CCD. It consists of a number of straight wire sections of any practical number that we can designate as  $N$ . Except for the feedpoint and the wire tips we must separate each section with a capacitor. Hence, the total number of capacitors will be  $N-2$ . The CCD simulates a continuously capacitively loaded 1-wavelength element by using equally spaced discrete components.

There is also a vertical version of the CCD. One way to create a vertical CCD is to simply use the center-fed antenna in a vertical installation. However, some literature suggests using the antenna against ground as a monopole. **Fig. 2** shows the general layout of this configuration.

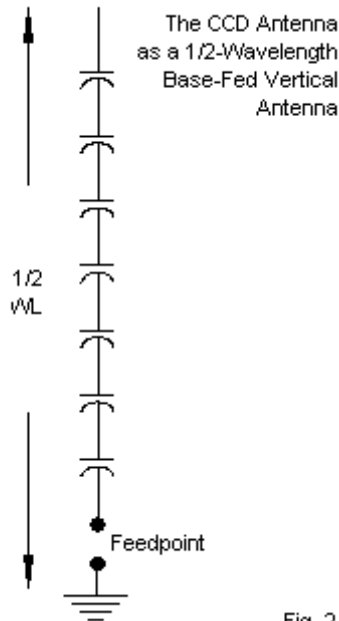

Fig. 2

Beyond the general claim of "improved performance," I have not encountered a very clear account of what advantages the CCD is supposed to offer. The wire length will be 1 physical wavelength. However, the distributed capacitive loading of the element will electrically shorten the wire. If we select the correct value for all of the capacitors (they are all equal), we can arrive at resonance, that is, a feedpoint impedance with negligible reactance. It appears that the idea behind the CCD is to avoid the very high impedance of a

1-wavelength center-fed wire while preserving its gain and directivity.

I sometimes hear the terms "aperture" applied to the antenna. Most texts reserve the term for use with highly directive antennas, such as UHF horns and the like. Nevertheless, the calculation of aperture rests--according to one text--on the wavelength, the directivity, the polarization match, and the impedance match. Since a comparison of a CCD with any other antenna will equate the wavelength, polarization, and impedance match, the remaining factor is directivity. Hence, if the CCD is an improvement over a legitimate comparator, then it will show improvements in directivity. We can examine the directivity of the CCD by looking at its gain and beamwidth.

To simplify the examination, let's look at the CCD on a common frequency. 3.5 MHz is widely used in articles, so that will be our choice. A wavelength at 3.5 MHz is 280.02' long, so we shall make the antenna length 280'. Throughout, we shall use AWG #14 copper wire to reflect typical amateur building practices. Our initial tests will use a free-space environment. In this environment, we must use the center-fed version of the antenna, but we shall not have to be concerned with vertical vs. horizontal orientations.

I chose to model the antenna in NEC-4, which creates a small difficulty. If I use a single wire for the entire element, I can place load capacitors on individual segments of the wire. However, the feedpoint region will not be quite perfect. **Fig. 3** shows the alternative models that I used. The upper model uses a single

source segment, but that does not ensure that the wire lengths on each side of the feedpoint are equal to the other segments between capacitors. The lower section uses a split source to simulate a source at the center segment junction. Although this move improves the segment spacing, it can result in somewhat erroneous impedance reports for very high impedances, where the impedance might change significantly with only a small change of feedpoint position or total wire length.

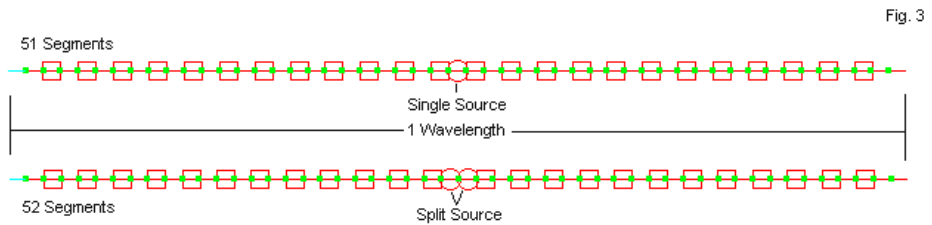

Two NEC Models of the 26-Section CCD

For all practical purposes, the difference between the models is not great enough to jeopardize the modeling analysis. The required values of capacitance tend to coincide closely with values in the literature. The next task involves the capacitors themselves.

Literature on the CCD shows that we can build the antenna with almost any number of wire sections and corresponding numbers of capacitors. Since constructing each section involves wiring in a capacitor with appropriate strain relief--a considerable task--I wondered what one might gain by opting for a "large" CCD over a

"smaller" CCD, where large and small indicate the number of wire sections and capacitors. Therefore, I created 2 models, one that used 26 wires section and 24 capacitors and another that used 50 wire sections and 48 capacitors.

The final step involves selecting the capacitor value. Since modeling allows easy variation of the capacitor value, we might explore the performance of the antenna in free space using various capacitor values. Let's start with the larger model. **Table 1** shows the results of this modeling exercise.

Table 1. Performance of a CCD in free space with 50 wire sections and 48 capacitors. All 48 capacitors have the same value.

Cap. pf	Split-Feed Model		Single-Feed Model	
	Gain dBi	Feed Z R+/-jX $\Omega$	Gain dBi	Feed Z R+/-jX $\Omega$
500	2.78	112 - j499	2.79	108 - j548
750	3.02	200 - j55	3.04	203 - j91
1000	3.18	313 + j308	3.19	330 + j288
1250	3.28	447 + j626	3.29	487 + j626
1500	3.35	602 + j914	3.36	676 + j933
1750	3.41	775 + j1174	3.41	894 + j1212
2000	3.45	965 + j1410	3.46	1139 + j1462
Resonance				
785	3.05	215 - j0.7		
807			3.08	229 + j0.1

Perhaps the first notable feature of the data is that as we raise the value of the capacitors in the string, the gain increases. So too does the resistive component of the feedpoint impedance. The reactive component shows an initial capacitive value that becomes inductive as we increase the capacitor values. This feature is natural enough, since increasing the capacitance value lowers the capacitive reactance along the wire. Since the wire is long compared to a dipole, lowering the compensating capacitive reactance will leave the feedpoint increasingly inductive.

In fact, more is at stake than just the feedpoint reactance. Note the entries for resonance. At resonance, the feedpoint reactance disappears, marking a balance between the inductive reactance of the wire and the capacitive reactance from the string of inserted components. Let's also examine the data for the "smaller" CCD that uses 26 wire sections and 24 capacitors. **Table 2** provides the necessary information, but with fewer steps along the way.

Table 2. Performance of a CCD in free space with 26 wire sections and 26 capacitors. All 24 capacitors have the same value.

Cap. pf	Split-Feed Model		Single-Feed Model	
	Gain dBi	Feed Z R+/-jX Ω	Gain dBi	Feed Z R+/-jX Ω
500	3.18	312 + j264	3.19	330 + j244
750	3.35	602 + j883	3.36	676 + j904
1000	3.45	965 + j1385	3.46	1140 + j1439
2000	3.61	2734 + j2456	3.62	3522 + j2248
Resonance				
410	3.08	229 + j0.1		
420			3.10	245 + j0.2

The antenna gain does not depend for its gain--above some minimum number of capacitors--on the array size in terms of the number of capacitors in each leg. The gain of the smaller array with 500-pF capacitors is the same as the gain of the larger array with 1000-pF capacitors and likewise for the smaller 1000-pF and the larger 2000-pF entries. The feedpoint impedance reports also track each other in the same manner. This result is also very reasonable, since 24 500-pF capacitors have the same capacitive reactance as 48 1000-pF capacitors if we measure at the same frequency.

The relative balance between these two factors alters the current distribution along the 1-wavelength wire. **Fig. 4** provides some samples of the distribution curves for the smaller array, but curves for corresponding large-array values are virtually identical. The

curve for the array with a low capacitance value that yield a capacitively reactive feedpoint impedance is very steep. At the other extreme, where the capacitor value yields an inductively reactive impedance, the curve shows dual current peaks. Only the capacitor values that yield resonance produce a curve that we tend to associate with a dipole.

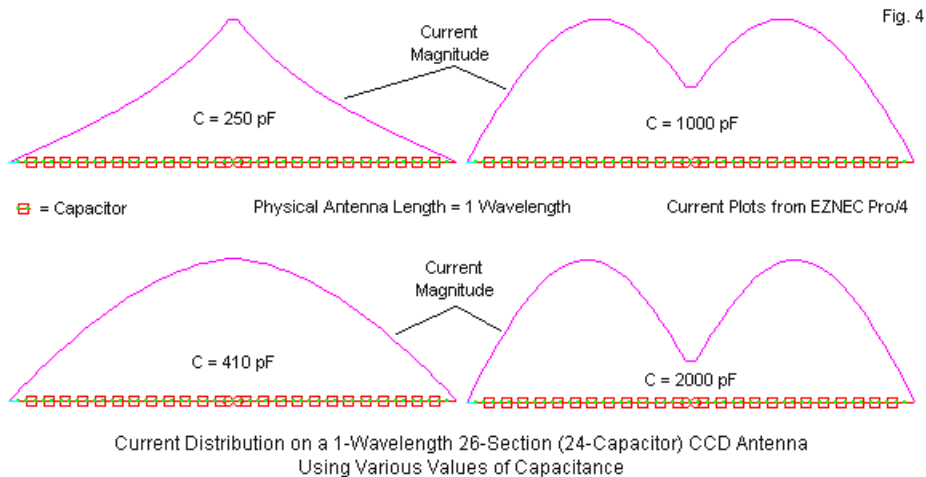

The resonant impedance of a center-fed CCD is in the neighborhood of 200 Ohms. Therefore, one may simplify the matching problem by installing a 4:1 balun at the feedpoint and using a standard coaxial cable feedline. Of course, one may also use parallel transmission line to either a tuner or a 4:1 balun at the shack end of the line. Since 200-Ohm feedlines are rare, one likely would need a 300-Ohm feedline cut to the nearest half-wavelength



(allowing for the line's velocity factor) at the operating frequency to minimize balun losses.

With the right choice of capacitors in the string, the CCD offers bi-directional performance with a resonant feedpoint impedance. In exchange for the more complex construction of the antenna, we obtain a simplification of matching requirements. However, we have not yet assessed how good that performance is. For that task, we need an appropriate comparator.

### **The CCD vs. the Dipole and 1-Wavelength Center-Fed Wire**

In CCD literature, the resonant 1/2-wavelength dipole seems to be the most popular antenna with which to compare the CCD with respect to performance as a horizontal antenna. An alternative comparator is the plain and simple 1-wavelength center-fed wire antenna. The 1-wavelength plain wire is the same length as the CCD. However, the current distribution of the plain wire differs from the current distribution of the resonant CCD. **Fig. 5** provides a set of free-space current distribution curves for the resonant dipole and for the 1-wavelength wire for ready comparison to the CCD curves in **Fig. 4**.

Fig. 5

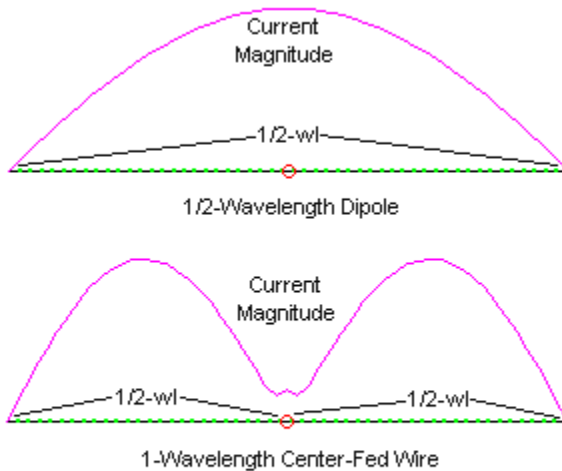

Current Distribution on a Resonant  $1/2$  Wavelength Dipole and on a 1-Wavelength (Physical Length) Center-Fed Wire

The dipole curve resembles the resonant CCD curve. Of course, neither is perfectly sinusoidal, since the voltage at the center feedpoint never goes to zero. I have not explored the degree to which each departs from that familiar curve. In contrast, the 1-wavelength wire curve most resembles the CCD when the latter uses a very high value for the capacitors and thus loads the wire least.

Table 3. Free-space performance of several antennas.  
 Note: All antennas use AWG #14 copper wire.

Antenna	Gain dBi	Feedpoint Z R +/- jX $\Omega$	Cap. pF
$\frac{1}{2}$ - $\lambda$ Dipole	2.02	74 + j0.7	---
1- $\lambda$ Center-fed Wire (with 600- $\Omega$ matching section)	3.79	5090 - j3330 49 + j2	---
Resonant Small CCD	3.10	245 + j0.2	420
Resonant Large CCD	3.08	229 + j0.1	807

**Table 3** compares the free-space performance of the dipole and 1-wavelength wire along with resonant CCDs of the smaller and larger type. Clearly, the CCD has more gain (by about 1.1 dB) than the dipole. However, the CCD falls about 0.7 dB short of the plain 1-wavelength wire. We should have expected this result from the tabular data on the CCDs as we raised the value of the capacitors and lowered the level of loading. (The capacitors in all models are lossless.) As the capacitive reactance decreased, the gain increased. From a certain perspective, we may view the 1-wavelength wire as a CCD with capacitors having an indefinitely high capacitance and hence negligible reactance.

Comparative Free-Space E-Plane  
Patterns: Resonant CCD  
and Simple Wire Antennas

Fig. 6

AWG #14 Copper Wire  
Lossless Capacitors  
3.5 MHz

Black = 1-wl Wire  
Blue = 1-wl 26-Section, 24-  
Capacitor Resonant CCD  
Red = Resonant 1/2-wl Dipole

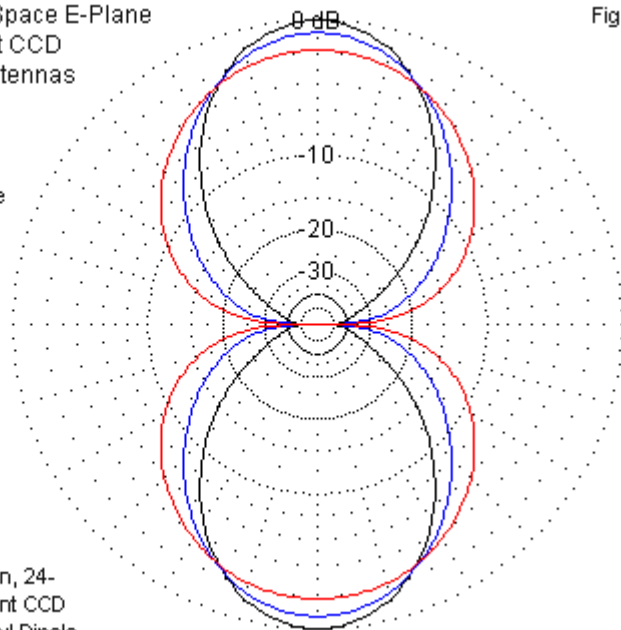

**Fig. 6** overlays the free-space E-plane (azimuth) patterns of the antennas (using only 1 of the resonant CCDs). The CCD pattern most resembles the E-plane pattern of a center-fed plain wire about 0.85-wavelength long, although the CCD beamwidth is close to 10 degrees wider.

Very few people operate 3.5-MHz antennas in free space. Therefore, we may usefully transplant all of the antennas in **Table 3**

to a height of 1 wavelength above ground. With this adjustment, we obtain the data in **Table 4**.

Table 4. Performance of several antennas 1  $\lambda$  above average ground.

Note: all antennas use AWG #14 copper wire.

Antenna	Gain dBi	TO Angle	Beam- width	Feedpoint Z R +/- jX $\Omega$	Cap. pF
$\frac{1}{2}\lambda$ Dipole	7.83	14°	77°	72 - j5	---
1- $\lambda$ Center-fed Wire (with 600- $\Omega$ matching section)	9.73	14°	48°	---	---
Resonant Small CCD	8.95	14°	58°	227 - j20	420
Resonant Large CCD	8.97	14°	58°	213 - j19	807

The gain differentials that we found in the free-space models hold up when we move the antennas over ground. Of course, the CCD loading technique does not alter the TO angle of the horizontal antenna relative to either comparator. **Table 4** records the horizontal beamwidth values for all of the antennas, and we can see that the CCD beamwidth is closer to the value for the dipole than it is to the value for the 1-wavelength plain wire. **Fig. 7** records the elevation and azimuth patterns for the antennas in this test group.

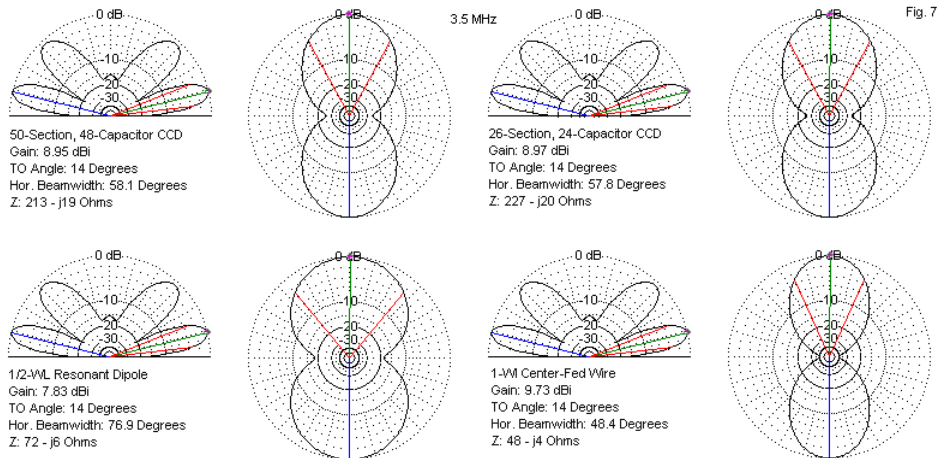

Horizontal CCDs and Comparators 1-Wavelength Above Average Ground

There is no difference among any of the elevation patterns, since those patterns emerge as a function of the height of the horizontal wire above ground. The 2 versions of the CCD show no differences in their azimuth patterns. Hence, the choice among the antennas with respect to performance largely hinges upon the combination of gain and beamwidth.

One of the seeming advantages of the CCD is the fact that in exchange for more complex construction, one obtains a higher gain with a simple resonant feedpoint. However, the tables have shown near-50-Ohm values for the plain 1-wavelength wire. The technique used to obtain such feedpoint values is very simple and very old. Since the terminal impedance of the 1-wavelength wire is very high, we can attach a 1/4-wavelength section of parallel transmission

line. Somewhere very close to the end of the line will be a 50-Ohm matching point. The matching sections for the horizontal 1-wavelength wires use 600-Ohm line. The required length for the impedances shown is 68' (compared to a full 1/4 wavelength of 70.25'). **Fig. 8** shows the simple set-up. The antenna environment and construction variables will determine the exact line length required, so the examples use a velocity factor of 1.0. Most 600-Ohm lines may have values between 0.95 and 0.98.

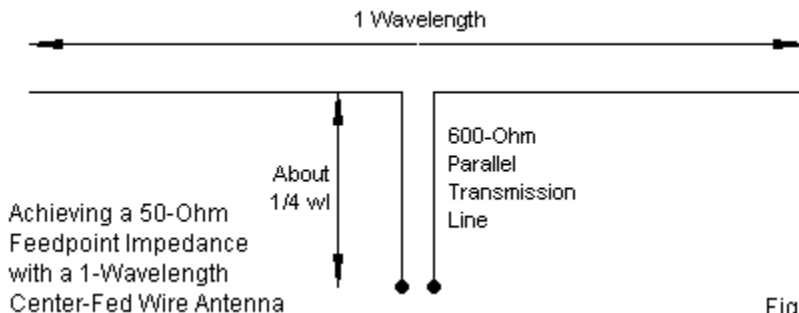

The matching section may be much simpler to build than the CCD antenna element. However, the 2:1 SWR bandwidth of the plain wire plus matching section is fairly narrow--perhaps 150 kHz at 3.5 MHz. (The resonant CCD has a 200-Ohm SWR bandwidth of about 300 kHz.) Indeed, the wisest feed system for the plain wire may be parallel line all the way to the shack antenna tuner. However, setting the line length to an odd multiple of a quarter wavelength at the most used frequency may ease the tuner's task by a good margin.

## The Vertical CCD and the 1/2-Wavelength Base-Fed Plain Wire

One application suggested for the CCD is as a vertical antenna. We may hang a full center-fed CCD vertically with its feedpoint at any height above ground that we can manage to support. However, the more interesting case is to use a half CCD as a monopole, with the feedpoint at ground level. A monopole CCD simply uses half the number of wire sections and half the number of capacitors as a center-fed horizontal CCD. Hence, the wire will be 1/2-wavelength long. We shall split the 26-section, 24-capacitor CCD and create a 14-section, 12-capacitor CCD.

The appropriate comparator for this antenna is a simple 1/2-wavelength monopole. The base feedpoint will use a matching section to arrive at a near-50-Ohm impedance. Because the natural impedance of a base-fed 1/2-wavelength monopole is lower than the impedance of a horizontal center-fed wire, we must use a parallel transmission line with a lower characteristic impedance. 450-Ohm line works well here, and a 68' length allows us to arrive at the desired impedance level. Again, the models use a velocity factor of 1.0, but an actual line would use the actual velocity factor for the selected line. As well, the variables of installation will likely require some experimentation to find the correct length.

The simplest way to model both antennas is to use a MININEC ground. The presumed advantage of using this ground system is that it allows direct contact between the lower end of the vertical wire and the ground without need for modeling radials. In some contexts, this system can be useful, but not in this case. In fact, the



MININEC ground obscures some critical differences between the operation of a CCD and a simple 1/2-wavelength base-fed wire.

To use a NEC-4 Sommerfeld-Norton ground with the antenna wire touching the ground requires that we install some kind of wire below ground. The simplest below ground wire might be a simulation of an 8' ground rod. Like the MININEC ground, this treatment is applicable to both antennas. Whether such a treatment is advisable is something that the data will tell us.

Alternatively, we can install a buried radial system using as few or as many radials as the analysis might dictate. The data in **Table 5** show 4-, 16-, and 32-radial systems, using 70' AWG #14 copper radials, for the CCD. The 1/2-wavelength wire only uses a 4-radial system for reasons that become apparent in the data.

Table 5. Performance of several vertical antennas.

Note: all antennas use AWG #14 copper wire.

## Antenna

 $\frac{1}{2}$ - $\lambda$  Vertical Monopole (with 68' 450- $\Omega$  matching section)

	Gain dBi	TO Angle	Feedpoint Z R +/- jX $\Omega$
1. MININEC ground	0.36	17°	55 - j3
2. NEC: 8' ground rod	0.29	17°	55 + j0.2
3. NEC: 4 70' buried radials	0.40	17°	55 + j0.5

 $\frac{1}{2}$ - $\lambda$  26-section CCD

	Gain dBi	TO Angle	Feedpoint Z R +/- jX $\Omega$	Cap. pF
1. MININEC ground	0.37	19°	114 + 0.8	394
2. NEC: 8' ground rod	-2.35	19°	219 + 0.8	405
3. NEC: 4 70' buried radials	-0.77	19°	141 + j0.5	381
4. NEC: 16 70' buried radials	0.06	19°	122 + j0.9	385
5. NEC: 32 70' buried radials	0.34	20°	115 - j0.5	385

Each antenna entry set begins with the MININEC ground. If we were to use this data, we would reach the conclusion that both antennas perform very similarly, with a negligible difference in gain and only a 2-degree difference in the TO angle. However, if we change to the S-N ground with an 8' ground rod, we obtain very different results. With no change in the TO angle, the plain wire outperforms the CCD by about 2.6 dB, a noticeable amount.

To improve performance of the CCD, we must replace the ground rod with radials. The table shows the results for radial fields of various sizes. For the CCD, adding 4 radials increases the gain by over 1.5 dB. Only when we have 32 radials does the CCD

challenge the gain of the plain 1/2-wavelength wire. The data for the plain wire shows that replacing the ground rod with 4 70' radials only increases gain by 0.1 dB. The small gain increment tends to suggest that a radial system is optional with a 1/2-wavelength wire. **Fig. 9** overlays the plain wire with ground rod pattern and two CCD patterns: one for the ground-rod model and the other for the model with 16 radials. The patterns reveal not only the gain differences, but also the TO angle differences for the two types of antennas.

Comparative Elevation Patterns  
of 2 Vertical CCD Antennas  
and a 1/2-Wavelength  
Base-Fed Wire

Fig. 9

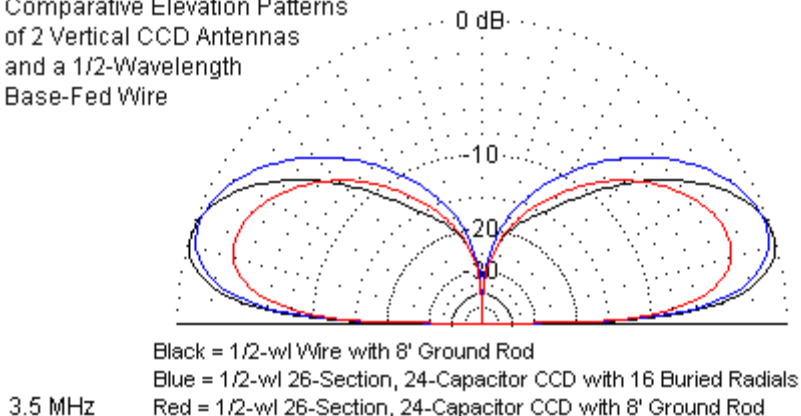

The difference in the radial requirements between the plain wire and the CCD emerges from the different current distributions on the two types of antennas. The sketch on the left in **Fig. 10** shows the distribution along the 1/2-wavelength simple wire monopole. The current maximum occurs at the wire center, which is elevated. Hence, the antenna shows a lower TO angle than the CCD. As

well, the current reaches a minimum at the base of the antenna. Essentially, the element is complete at that point and requires only a good RF ground. The 4 radials provide a better distributed RF ground than the simple rod, but the performance difference is small.

In contrast, the CCD design places a current maximum at the base of the monopole installation. Maximum efficiency requires an effective completion of the antenna in the form of a low-loss radial system. The more radials that we have, the more efficient will be the total antenna system, as indicated by the declining resistive component of the feedpoint impedance as we add more radials. Note, however, that as we bring the system to a level of maximum efficiency, the TO angle actually increases. At a high efficiency level, the feedpoint would need a 2:1 impedance transformation device or network for compatibility with the standard 50-Ohm coaxial cable.

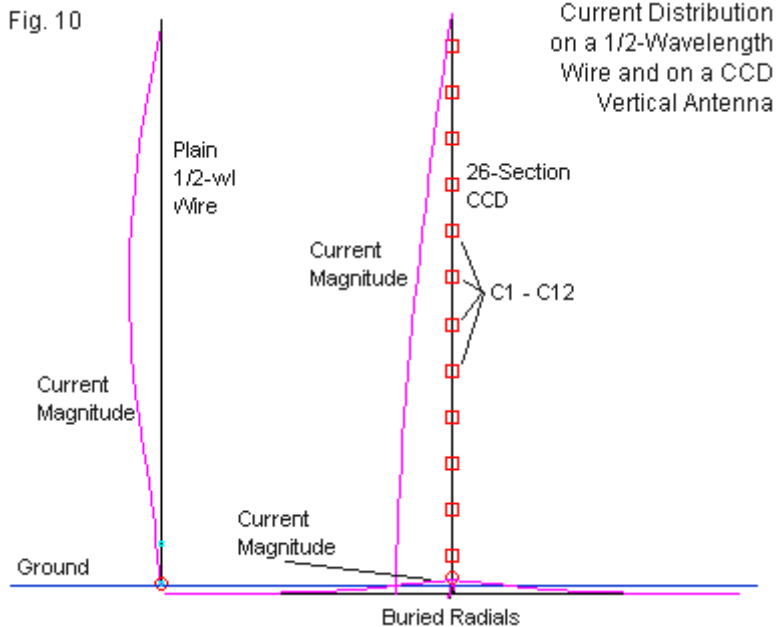

An effective monopole CCD system thus requires two forms of construction complexity relative to the plain 1/2-wavelength wire: the installation of capacitors along the monopole and the burying of a large number of radial wires. In contrast, the plain 1/2-wavelength wire needs no modification of the monopole wire and provides good service at a lower TO angle with only a ground rod or the simplest of radial systems. However, the high impedance of the antenna may require a dedicated network or a carefully tuned matching section to arrive at a 50-Ohm impedance.

## How "Small" Can I Make a CCD?"

The terms "large" and "small" in connection with the discussion of CCDs in these notes refer to the number of wire sections and the number of capacitors needed to make up a 1-wavelength antenna. In our initial free-space modeling experiments, we saw that there is no significant difference in the performance of a 26-section, 24-capacitor CCD and a 50-section, 48-capacitor version. Since the smaller of the two systems requires less work than the larger, we may naturally pose a question: how small can I make the CCD antenna and still achieve proper performance. Since the goal is a self-resonant 1-wavelength antenna, we have a criterion for success.

Models of the free-space center-fed CCD seemed unable to achieve resonance with 6 or fewer capacitors. However, an 8-capacitor, 10-section model of the antenna did achieve resonance. The feedpoint impedance was considerably lower than the 200-Ohm target that we have used in order to apply a 4:1 balun at the feedpoint. As well, the gain was down slightly relative to larger models, but not enough to be operationally significant. **Table 6** shows the results obtain from several different models leading up to the 26-section, 24-capacitor model.

Table 6. Free-space performance data for center-fed CCD antennas of various sizes. Note: Size refers to the number of wire sections and the number of capacitors. All antennas are  $1\text{-}\lambda$  long using AWG #14 copper wire at 3.5 MHz.

Antenna Size		Gain	Beam	Feedpoint Z	Cap.
Sections	Capacitors	dBi	Width	R +/- jX $\Omega$	pF
10	8	2.95	59°	170 + j2	125
14	12	3.00	58°	185 + j3	189
18	16	3.02	57°	193 - j0.3	255
26	24	3.10	56°	245 + j0.2	420

Note that between the worst and the best of the model set, we have only a 0.15-dB difference in gain. As well, the beamwidth changes by only 3 degrees, indicating a stable E-plane pattern. However, the feedpoint impedance climbs from about 170 Ohms to well over 200 Ohms. The differences in the gain levels and the feedpoint impedance values result from the fact that the current distribution curve changes as we move from fewer to more wire sections and capacitors. **Fig. 11** provides a sense of the evolution of the distribution curve from essentially a triangle to a smooth curve.

Fig. 11

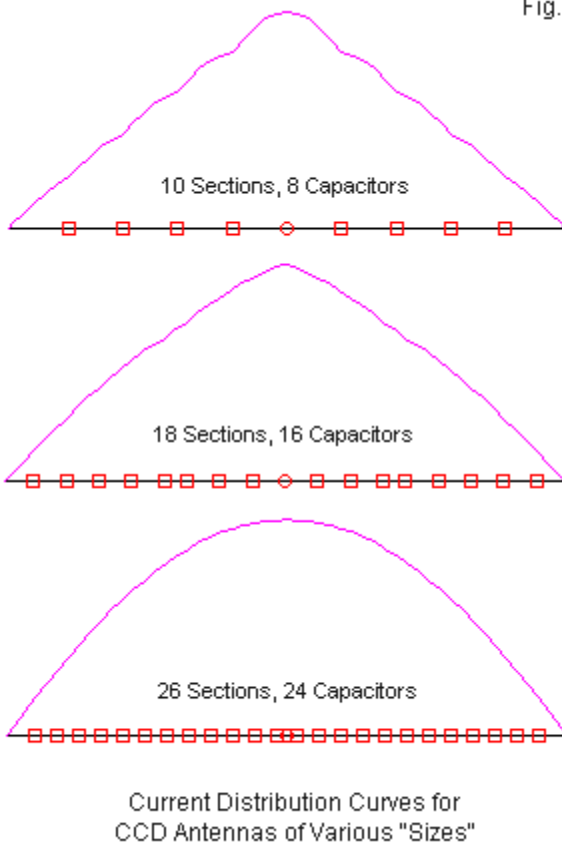

The shapes of the current magnitude distribution curve do not materially affect the shape of the radiation pattern, which remains well-behaved and bi-directional. The absence of any significant



change in the beamwidth is a further indication that even the 8-capacitor version of the antenna will perform well.

The answer to the section's lead question then is that about 8-capacitors and 10-wire section form the smallest practical CCD with full performance and resonance. It is likely that the precision of the match between capacitors and between wire sections will play a stronger role for the small CCD than it does for larger versions.

## Conclusion

We have taken a short look at the controlled current distribution (CCD) center-fed 1-wavelength antenna with an eye toward understanding its operation and assessing its virtues. The center-fed version of the antenna provides a 200-Ohm resonant feedpoint impedance with the choice of the correct capacitor size, compared to the 70-Ohm impedance of a 1/2-wavelength dipole and the very high impedance of a plain center-fed 1-wavelength wire. The CCD gain and beamwidth values fall between those of the two antennas used as comparators. Models suggest that CCD performance peaks with about 26 wire sections and 24 capacitors. However, CCDs as "small" as 8 capacitors and 10 wire sections may work satisfactorily.

The vertical monopole version of the antenna is perhaps more problematical, since when ground mounted, it requires an extensive radial system for most efficient operation. Unlike the plain 1/2-wavelength wire monopole that has an elevated point of maximum current, the CCD vertical monopole reaches maximum current at

ground level and thus requires radials to complete the radiating structure.

Essentially, the CCD simulates with discrete components a continuously loaded element with 501 pF/meter. At this loading level, the gain in free space is 3.10 dBi, with a feedpoint impedance of  $245 - j0.2$  Ohms. The performance reports are virtually identical to those that emerge from the 26-section, 24-capacitor antenna that used 420 pF capacitors.

The CCD is a viable and potentially useful antenna of its type. Whether the advantages warrant the relatively complex construction compared to simpler wire antennas is a user judgment.

## Chapter 50: A Universal HF Back-Up Antenna

I have had occasion in the past to write on the W2EEY Expanded/Extended Lazy-H array that first appeared in the 1960s as a mono-band wire array. W6SAI later discovered that the antenna had available gain on frequencies in a range of at least 2:1. In other words, a 10-meter version of the antenna might be still useful on 20 meters.

My own looks into this antenna suggest an even wider range of utility, even though performance tapers off steadily as one lowers frequency. The chief drawback of the antenna has so far been the fixation on wire construction. I wondered what tubular elements might do, and the result is this preliminary note.

Large antenna farms for serious DX and contest use often have far more than one antenna per band. Hence, back-up on many bands is almost a matter of course. However, there is often only one antenna for each of the following bands: 40, 30, 17, and 12.

Now suppose there were a single rotatable antenna of relatively easy maintenance (compared to a 5-element Yagi or similar) that might provide emergency performance on 40 through 10 meters, performance that was not stellar, but usable in a crunch. Further suppose that the antenna had a top height of not more than say 70' (about 1/2 wl on 40 meters) and has elements no longer than some of the half-size 40-meter beams that are commercially available. Finally, suppose that the antenna required no boom, but looked

more like one of those 40-meter beams flopped over to point straight up.

Such an antenna is not a mechanically simple installation, since 44' foot aluminum elements are not for the beginner. However, once installed, the antenna poses fewer stress problems than horizontally positioned arrays that require a boom. If it happened also be to bi-directional, then it might be laid close in to a pole or tower, since the total required rotation is 180 degrees.

There might be a niche for such an antenna, so the performance potentials and the installation challenges seem worth exploring, at least on a preliminary basis.

### **The W2EY Expanded/Extended Lazy-H**

The basic array is an extension of the Lazy-H: two 1 wl elements vertically separated by  $1/2$  wl and fed in phase. The W2EY innovation was to extend the elements to 1.25 wl, extended double Zepp length. He also expanded the separation to  $5/8$  wl to maximize in-phase gain.

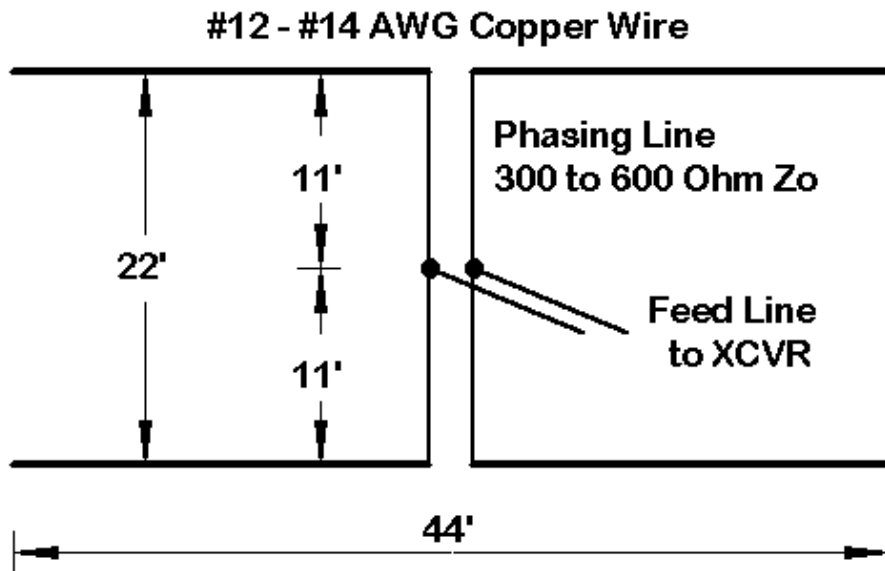

**Fig. 1** W2EEY "Expanded Lazy-H Antenna"

**Fig. 1** shows the outlines of a typical extended Lazy-H in typical wire form. For many years, the Editors and Engineers *Radio Handbook* (edited by W6SAI) has carried that standard Lazy-H, fed at the bottom with a stub for coax matching for mono-band use. However, for multi-band use, a center junction of equal lengths of feedline is the simplest route to in-phase feeding on many bands.

The dimensions of the array for 10 meters are a modest 44' element length and 22' vertical separation. The EDZ element

lengths represent the practical limit for use on HF bands, including 10 meters. Longer elements will yield a multi-lobe pattern on 10 meters.

The antenna height selected for study was a 66' top height. It can be mounted higher or lower with standard changes in the elevation angle of maximum radiation. However, a height of at least 66' seems advisable for reasonable 40-meter use.

### **From Wire to Tubing**

I have elsewhere looked at the performance of the W2EEY version of the antenna across many bands. The question that came to mind regarding rotating the array required a change in element material. So I redesigned the antenna for aluminum tubing having an aggressive tapering schedule.

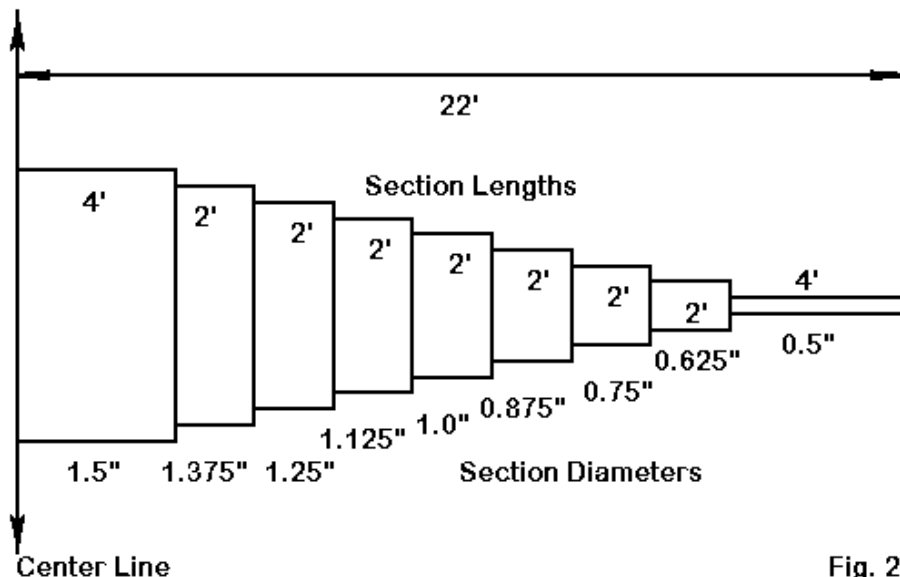

Fig. 2

**Fig. 2** shows the arrangement used to develop models. There is no assurance that this particular schedule meets appropriate standards. Any actual elements that one might contemplate constructing should be taken through an exercise or two on YagiStress to determine their mechanical feasibility. Although the schedule used here has proven very useful in comparing wire versions of the antenna to the most severe gradations I could think of, the element design is hypothetical only in mechanical terms.

**Special Note:** Carroll Allen, AA2NN, pointed out the taper schedule suggested would have a wind survival rating of only about 70 mph. He developed a spread sheet for EXCEL to calculate the stress on the tubing. For commonly used antenna tubing, such as 6061-T6, with a wall thickness of 0.058", the maximum stress for each section should be 40,000 psi or less. He kindly redesigned the sections for a 100 mph wind survival rating. The following table presents the revised taper schedule. Like the original schedule, the 1.125" diameter section is presumed to run all the way through the 1.25" section, but also to have its own exposure length.

44' Aluminum Doublet Half-Element Structure  
for 100 MPH Wind Survival

Diameter (")	Section L (")	Cumulative L (")
1.25	72	72
1.125	19	91
1.0	20.5	111.5
0.875	21.5	133
0.75	23	156
0.625	24	180
0.5	84	264

The chief differences between the wire and tubing versions of the antenna were two. First, the models had many more wires. Second, the source impedances (as taken at the junction of the two feedlines from the elements to a center small segment) varied somewhat from those associated with the wire version.



For those unfamiliar with the extended Lazy-H, let's run a series of tabular entries and some patterns to check the potential performance. As with all models, these assume level, uncluttered terrain (average Sommerfeld-Norton ground) in NEC-4.1. Any serious antenna farmer has already run terrain analysis using N6BV or K6STI software and can therefore adjust the numbers for gain and elevation angles accordingly.

The figures in the first table focus on performance. The frequencies are band centers. Gain is maximum at the elevation angle of maximum radiation (TO angle). Note that gain is bi-directional. The horizontal beamwidth is to the -3 dB points on the maximum gain curve.

Frequency MHz	Gain dBi	TO Angle degrees	Horizontal Beamwidth (deg)	Notes
28.5	15.2	8	37	EDZ-type side lobes
24.94	14.7	10	41	
21.225	12.6	11	52	Standard Lazy-H
18.118	11.0	13	61	
14.175	9.1	17	73	
10.125	8.2	24	85	
7.15	6.5	33	99	
7.15	7.2	29	89	Using top wire only

As the table shows, gain decreases steadily with frequency, since the elements grow shorter and the spacing narrower. The 10-meter gain is similar to a long-boom 5-element Yagi (without the front-to-back ratio). On 15, gain performance is similar to some 3-element Yagis, dropping to 2-element performance on 17. Below that

frequency, the antenna becomes the equivalent of a rotatable dipole.

The patterns to follow, band by band, show the elevation patterns along the axis of maximum gain. Only spot azimuth patterns (for 10, 15 and 30 meters) are shown, since the evolution of the azimuth pattern with frequency changes is perfectly normal. One key advantage for the array is the relative absence of very strong high angle radiation, especially on the upper bands, thus reducing a potential noise source.

Extended Lazy-H  
28.5 MHz

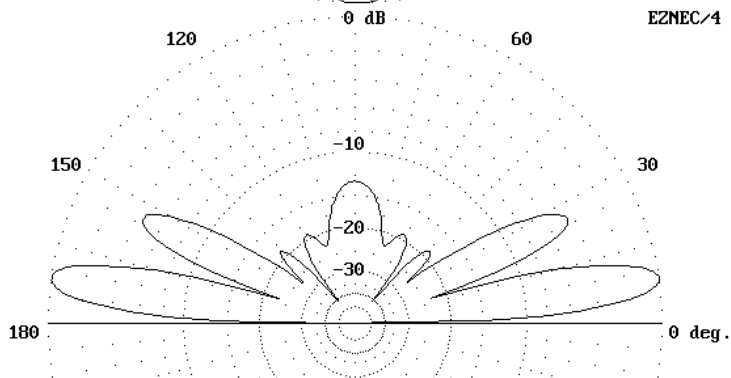
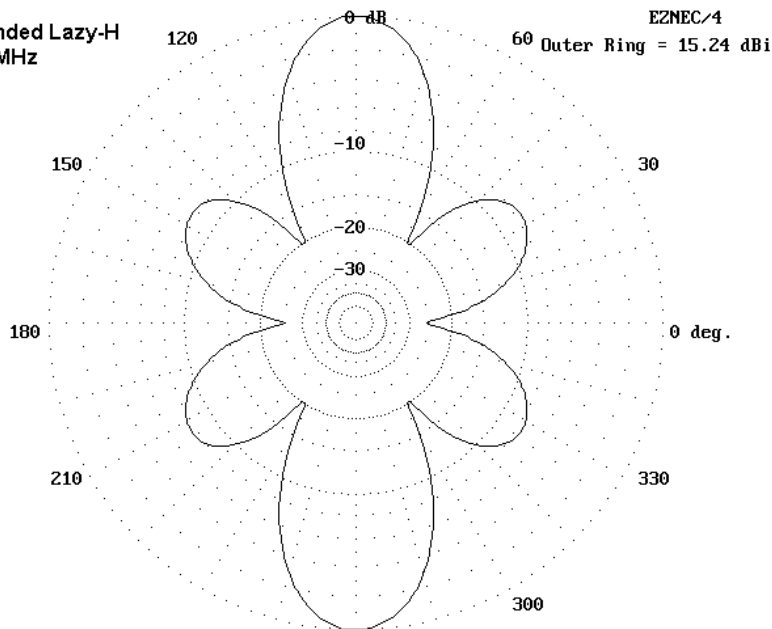

10-Meters

Extended Lazy-H  
24.94 MHz

EZNEC/4

60 Outer Ring = 14.69 dBi

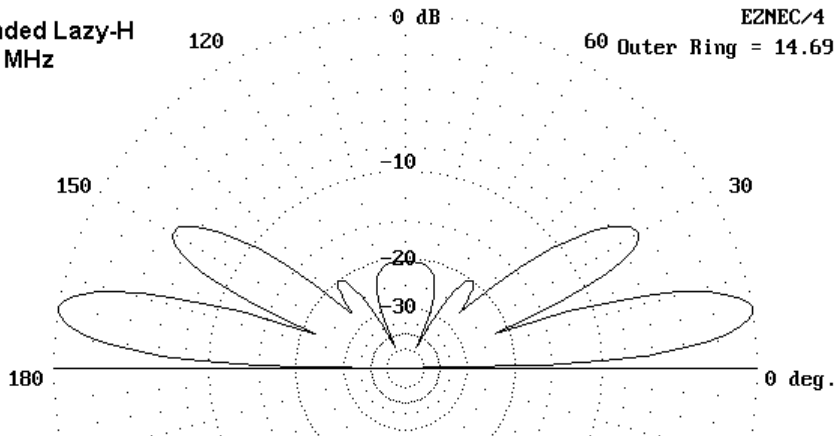

12-Meters

Extended Lazy-H  
21.225 MHz

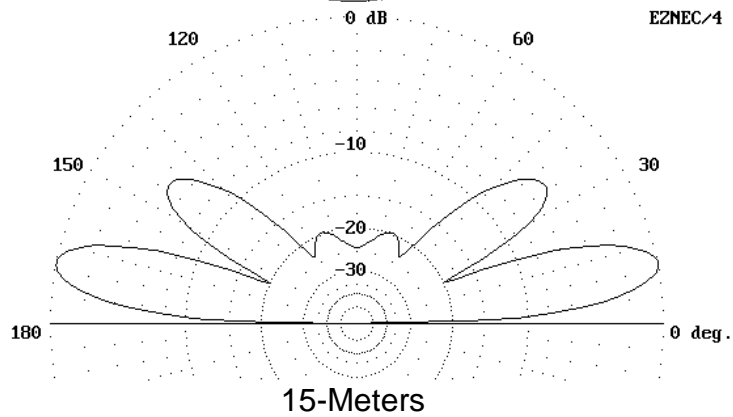
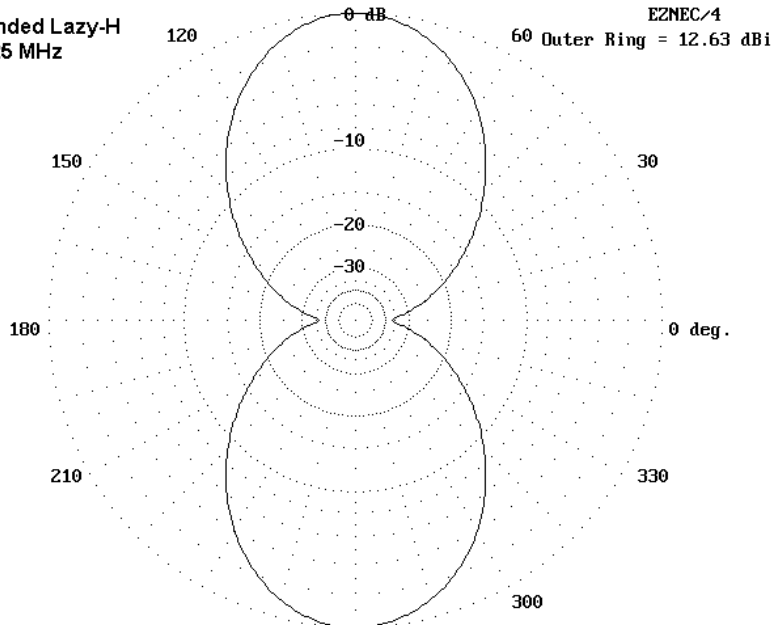

Extended Lazy-H  
18.118 MHz

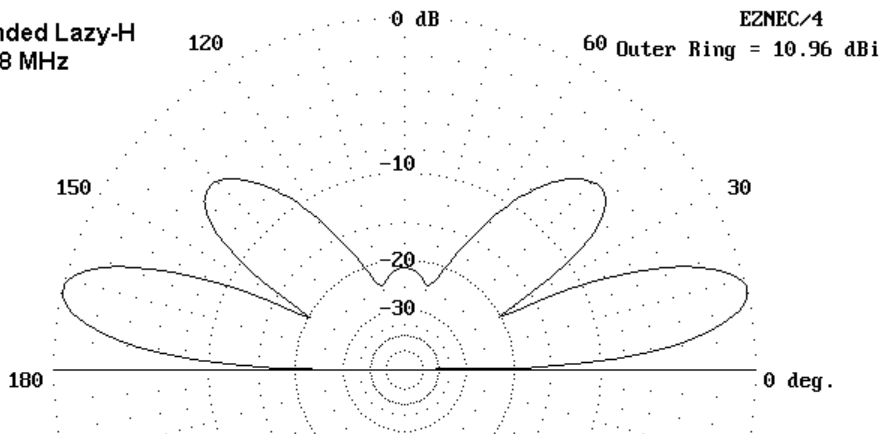

17-Meters

Extended Lazy-H  
14.175 MHz

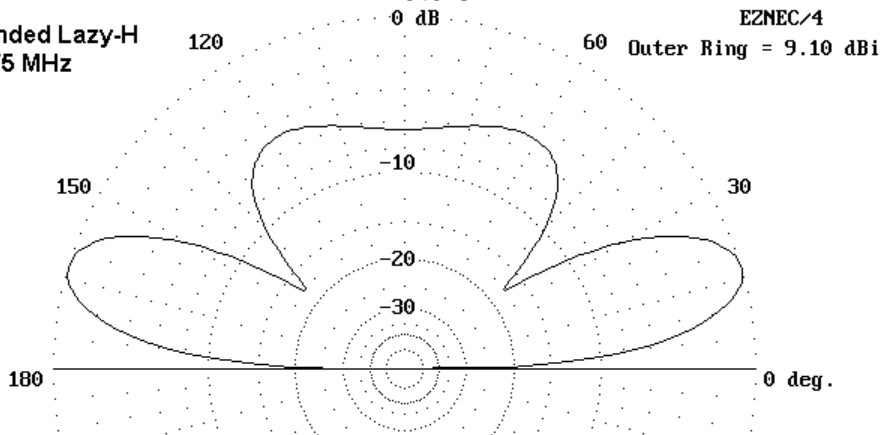

20-Meters

Extended Lazy-H  
10.125 MHz

EZNEC/4  
Outer Ring = 8.19 dBi

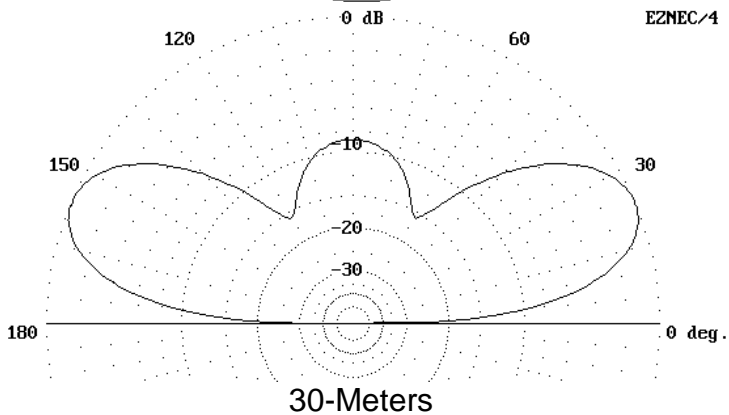
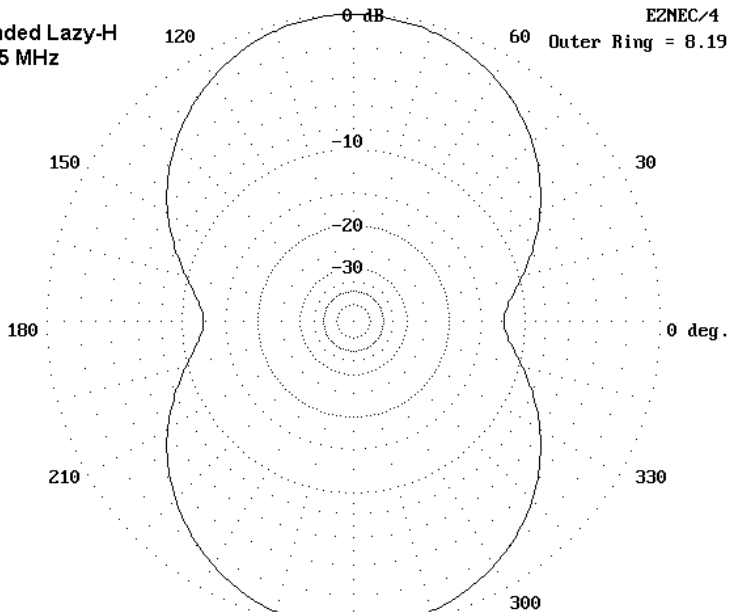

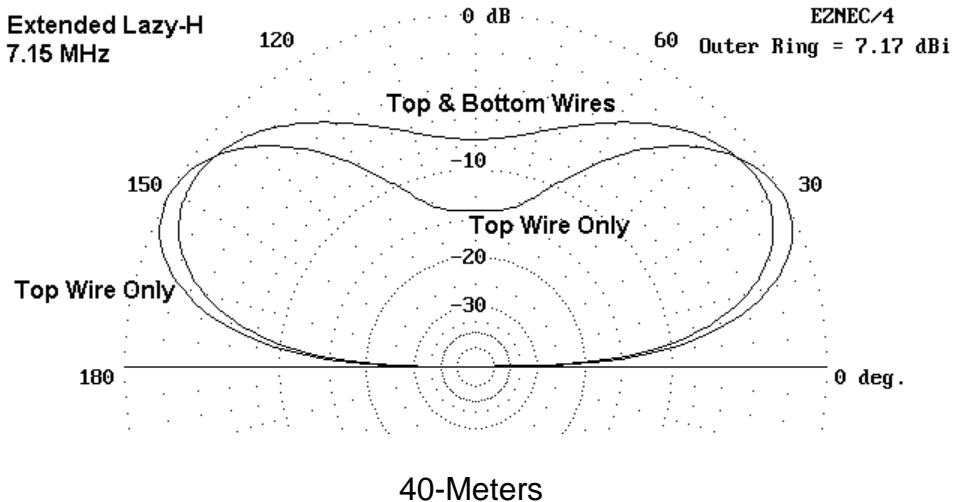

The 40 meter graphic shows two patterns, one for the use of both wires in phase, the other for the use of only the top wire. The latter is harder to implement in practice, but increases gain while lowering the take-off angle. On 30 meters, the use of only the top wire gives the appearance of lowering the take-off angle, but in fact, the bottom lines of the two patterns overlap, with the 2-wire system showing more gain. The seemingly unexpected result comes from a difference between vertical beamwidths for the two arrangements. Hence, on 30, the phased 2-wire system appears to offer superior overall performance.

The decrease in gain for each reduction in frequency is clearly apparent. Given the array of antennas that inhabit some of the most extensive antenna farms, one might judge 20-meter performance to



be the weakest in comparative terms. WARC band antennas tend to be simpler, and relative to them, the array is down by only a couple of dB at most. (If one has designed against these tendencies, then the differentials will also be different.) From 15 meters upward, the array gain is quite good--indeed, competitive might be a reasonable term. However, on 20, 5-element Yagis are fairly common (as are stacks of beams that give similar performance). The array on 20 yields performance similar to that of a 1 wl wire, perhaps 2 S-units weaker than the high-performance main antenna(s).

Nonetheless, the overall performance of the array relative to all of the antennas in use for every band must be accounted quite good in view of what the antenna is in this application: it is an emergency back-up capable of being switch in to replace any antenna system that goes dead when Murphy dictates. With a size similar to a half-size 40-meter 2-element Yagi pointing straight up, it is also much simpler than its most cogent competitor: a log-periodic for 40-10 meters.

## Phase Lines

The models developed here used 600-Ohm,  $VF=1.0$  lines for phasing. Each line was cut to 14' even though the distance to the center point was 11' only. A 3' buffer was allowed for each line to account for routing that would clear any metallic structures that might disrupt standard performance of the lines.

With these constraints, the models yield the following source impedance calculations.

Frequency MHz	Source Impedance R +/- jX Ohms	Notes
28.5	140 - j 655	Highly variable with change of $Z_0$
24.94	335 + j 655	Somewhat variable with changes of $Z_0$
21.225	110 + j 85	Decreases with $Z_0$ decreases
18.118	165 - j 135	Decreases with $Z_0$ decreases
14.175	880 - j 136	Highly variable with change of $Z_0$
10.125	65 + j 250	Reasonably stable
7.15	14 + j 10	Low and stable
7.15	14 + j 30	Top-wire only in use, with line.

The number of cases in which the source impedance decreases with lower characteristic impedance phasing lines suggest that the highest feasible value of  $Z_0$  be used for the antenna. Indeed, with lower values of  $Z_0$ , the 40-meter source impedance can decrease below 10 Ohms, rapidly escalating the negative effects of loss sources in any installation.

High variability with changes in phasing line type tend to indicate that the builder of any antenna of this type may encounter quite different source impedances owing to minor local variations. Although the phased pair of 44' doublets yields lower ratios of reactance to resistance, relative to a single 44' doublet, the low impedance at 40 meters may prove difficult to match at the tuner end of the line. The reactance will vary more widely than the resistance over a greater section of each half-wavelength of line. Hence, careful line-length selection may prove necessary, although this factor will vary with the particular tuner configuration and internal components.

On the basis of these results (typical of several different models), there appear to be three initially plausible feed systems.

**1. Parallel feedline and an ATU:** The simplest feed system is to use parallel feedline from the juncture of the phasing lines to the operating position, with an ATU providing the requisite matching for minimum loss in the matching system and for maximum isolation of equipment from common mode currents, a link-coupled tuner is recommended (with due construction precautions against unintended common mode paths). Without careful measurement of the actual source impedances encountered and equally careful measurement of the feedline length, there may be cases in which the impedance presented to the tuner terminals falls outside the range for which the tuner can effect a match while compensating for reactances at that point. Ordinarily, changing the line length in small increments will overcome this problem without incurring significant losses.

**2. Remote switching of matching circuits--Version 1:** A box of fair proportions installed at or very near the junction of the two phase lines might contain an array of circuits matching the source impedance on each band to standard 50-Ohm coaxial cable (or 75-Ohm hardline). The system would require a power source to control separate input and output sides of each network. The design of such a system would have to be a custom installation based on the actual source impedances of the system.

**3. Remote switching of matching circuits--Version 2:** A remotely switched matching network box mounted precisely at the junction of

phase lines may present mechanical problems if the installation has a rotating mast joining the two elements. Moreover, the impedances to be matched may not be the most desirable. A length of open-wire parallel feeder from the phase line junction to some point further down the support structure may provide more desirable values and a more convenient mechanical installation. Since the variables of this modified system are so many, I have not explored any particular line lengths to check feasibility. Hence, electrically, this system can only be classed as equivalent to the first version.

Either remote matching system serves a certain preference among antenna farmers: the desire to present sensitive rigs and amplifiers with loads that require no in-shack tuning during intensive operations. All adjustments are made during installation and remade during routine maintenance. Those willing to make real-time adjustments and who can correctly install open-wire feeders may wish to use the simplest of the systems outlined here.

Of the three systems, only the remote box at the phase-line junction is amenable to easy switch-over to using only the top wire on 40 meters. Adapting the other systems to such use will be an exercise in ingenuity.

## Mechanical Considerations

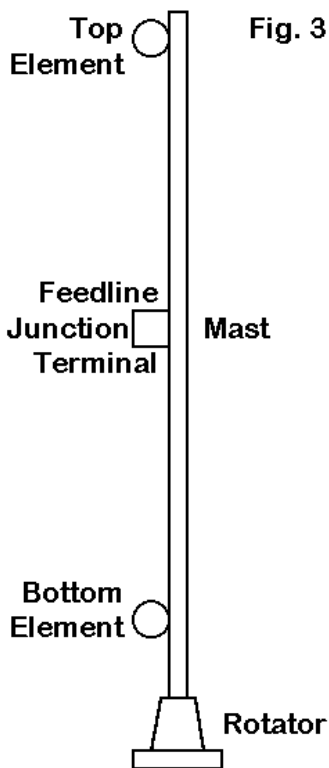

Fig. 3 The basic elements of the antenna structure appear in **Fig. 3**.

No support structure is shown, since this aspect of the installation is subject to so many variations. The antenna itself consists of two 44' long elements of considerable weight. The top one will be 22' above the lower one, which might be considered a moderate stacking challenge to those with large antenna farms. Since the elements are mounted close to the line of the rotating support mast, the stresses they impose upon the assembly may be less than those of elements at the ends of a boom. A mast extension to handle a truss system to add support farther out along the elements is certainly feasible and may well be advisable.

If the lower element is (or both elements are) are side-mounted relative to a supporting pole or tower, then there will be a dead zone in the rotation. The size of this zone in degrees will vary inversely with the distance of the mast from the support structure. If we assume that there is a direction from the station that can be

ignored, side-mounting may offer a means of installing the emergency antenna on an existing tower or pole. However, the elements may well interfere with existing guy wires.

These mechanical notes are offered on the premise that anyone thinking about this antenna has considerable experience with tall installations and can integrate the structure into a considerable backlog of diverse variables involved in high pole and high tower work. Those who may be reading these very preliminary notes without requisite experience should perhaps review some of the very considerable stack of reprints offer by Champion (K7LXC) before becoming too much attracted to the ideas noted here.

The aluminum extended Lazy-H is a bi-directional array with rotational capabilities that may make use of its reasonably narrow horizontal beamwidth on 40 through 10 meters. As such, it may fill a special niche, which I have termed the nearly-universal back-up for giant antenna farms. The feed system challenges are more electronic than they are mechanical--except for mounting and water-proofing a box for two of the suggested systems. Otherwise, the array presents fewer mechanical problems than most very large Yagis.

Still, the array not a cure-all for whatever ails. Nor is it a magic elixir for all antenna installations. The notes presented here simply suggest that for some installations, the antenna may provide that nearly universal back-up which is ever handy: ready to go on 40 to 10 meters when Murphy strikes down the primary antenna(s). Just

do not tell Murphy you have installed one of these or he will take down your antennas two at a time.

## Other Publications

We hope you've enjoyed Volumes 1 & 2 in a series of books of the **Antennas Made from Wires**. Watch for Volume 3 to be released soon. You'll find many other very fine books and publications by the author L.B. Cebik, W4RNL and others in the ***antenneX Online Magazine BookShelf*** at the web site shown below.

---

***A Publication by  
antenneX Online Magazine  
<http://www.antennex.com/>  
POB 271229  
Corpus Christi, Texas 78427-1229  
USA***

---

Copyright © 2010 by ***antenneX Online Magazine***. All rights reserved. No part of this book may be reproduced or transmitted in any form, by any means (electronic, photocopying, recording, or otherwise) without the prior written permission of the publisher.

ISBN: 1-877992-86-0

---